

476

1) COLORADO

UNIVERSITY OF
MANITOBA
APR 29 1943
March 1943
SCIENCE LIBRARY

3) 4)
Bulletin 476

Mechanical Thinning of Sugar Beets

E. M. MERVINE
R. D. BARMINGTON

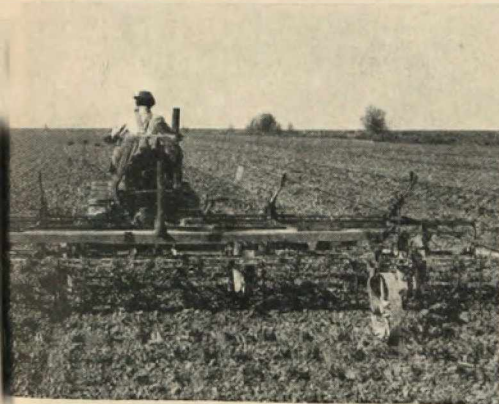

Mechanical Thinning

2.5 Man hours per acre
12.24 Tons yield



Hand Thinning

27.2 Man hours per acre
12.19 Tons yield

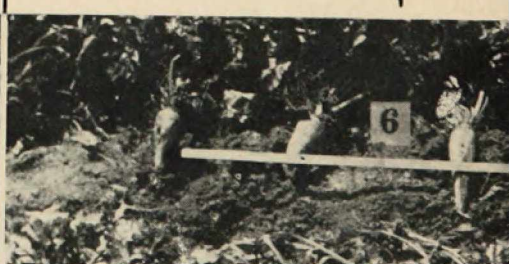
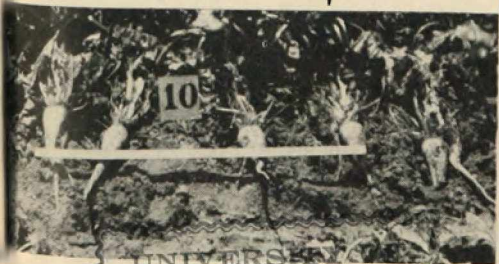

UNIVERSITY OF
MANITOBA

Colorado Agricultural Experiment Station
APR 29 1943

Colorado State College

SCIENCE LIBRARY

Fort Collins

COLORADO STATE COLLEGE
COLORADO AGRICULTURAL EXPERIMENT STATION
FORT COLLINS, COLORADO
STATE BOARD OF AGRICULTURE

LEON S. McCANDLESS, Pres. Craig	J. W. GOSS Pueblo
CHARLES W. LILLEY, Vice Pres.	R. F. ROCKWELL Paonia
..... Virginia Dale	W. I. GIFFORD Hesperus
GEORGE McCLAVE McClave	REX EATON Eaton
ROBERT ROEMER Fort Collins	

Ex-officio { GOVERNOR JOHN C. VIVIAN
 { PRESIDENT ROY M. GREEN

EXPERIMENT STATION OFFICERS

ROY M. GREEN, M. S., D.Sc. President	JAMES R. MILLER Secretary
HOMER J. HENNEY, M. S. Director	MARVIN J. RUSSELL, A. B. Editor
SADIE I. COOLEY, B. S. Clerk	

EXPERIMENT STATION STAFF

AGRICULTURAL DIVISION

Agronomy

Alvin Kezer, A.M., Chief Agronomist
 David W. Robertson, Ph.D., Agronomist
 *Robert Gardner, M.S., Associate
 Agronomist (Soils)
 †Warren H. Leonard, Ph.D., Associate
 Agronomist
 Dale S. Romine, M.S., Associate
 Agronomist (Soils)
 †Ralph Wehling, Ph.D., Assistant
 Agronomist
 †Robert Whitney, M.S., Assistant
 Agronomist (Soils)
 Robert F. Eslick, M.S., Assistant
 Agronomist

Animal Investigations

R. C. Tom, M.S., Associate Animal
 Husbandman, Acting in Charge
 L. E. Washburn, Ph.D., Associate Animal
 Husbandman
 Howard C. Dickey, Ph.D., Associate
 Animal Husbandman
 W. E. Connell, M.S., Associate Animal
 Husbandman
 H. H. Stonaker, Ph.D., Associate Animal
 Husbandman
 †Melvin Hazaleus, M.S., Assistant
 Animal Husbandman
 A. Lamar Esplin, M.S., Assistant
 Animal Husbandman
 Eugene Bertone, B.S., Assistant Animal
 Husbandman

Botany and Plant Pathology

L. W. Durrell, Ph.D., Botanist and Plant
 Pathologist
 Bruce J. Thornton, M.S., Associate
 Botanist
 E. W. Bodine, M.S., Associate Plant
 Pathologist
 W. A. Kreutzer, Ph.D., Associate Plant
 Pathologist
 A. O. Simonds, Ph.D., Assistant Botanist
 M. E. Paddock, Ph.D., Assistant Plant
 Physiologist
 J. L. Forsberg, M.S., Assistant Plant
 Pathologist

Chemistry

J. W. Tobiska, M.A., Chemist
 Earl Douglass, M.S., Associate Chemist
 C. E. Vail, M.A., Associate Chemist
 C. F. Metz, Ph.D., Associate Chemist
 Lowell Charkey, M.S., Assistant Chemist
 Merle G. Payne, B.S., Assistant Chemist

Entomology

Charles R. Jones, Ph. D., Entomologist
 George M. List, Ph.D., Associate
 Entomologist
 John L. Hoerner, M. S., Associate
 Entomologist
 Leslie B. Daniels, M.S., Associate
 Entomologist

Horticulture

A. M. Binkley, M.S., Horticulturist
 Louis R. Bryant, Ph.D., Associate
 Horticulturist
 John G. McLean, Ph.D., Associate
 Horticulturist
 †George A. Beach, M.S., Assistant
 Horticulturist
 Walter C. Sparks, B.S., Assistant in
 Horticulture

† On military leave
 * On leave

Home Economics

Inga M. K. Allison, S.M., Home Economist
 W. E. Pyke, Ph.D., Associate in Home
 Economics Research
 Elizabeth Dyar, Ph.D., Associate in Home
 Economics Research
 Hazel Stevens, M.S., Assistant in Home
 Economics Research

Pathology and Bacteriology

Floyd Cross, D.V.M., Veterinary Pathologist
 I. E. Newsom, B.S., D.V.S., D.Sc.,
 Veterinary Pathologist
 Dudley P. Glick, Ph.D., Associate
 Bacteriologist
 Hilton A. Smith, D.V.M., M.S., Associate
 Veterinary Pathologist
 G. S. Harshfield, D.V.M., M.S., Associate
 Veterinary Pathologist
 A. W. Deem, D.V.M., M.S., Assistant
 Veterinary Bacteriologist
 Frank X. Gassner, D.V.M., Assistant
 Pathologist
 †Max E. Tyler, M.S., Assistant Bacteriologist

Poultry

†H. S. Wilgus, Jr., Ph.D., Poultry
 Husbandman

Range and Pasture Management

E. W. Nelson, A.M., Range Conservationist
 *Clinton H. Wasser, B.S., Assistant in Range
 Management
 †Frank J. Kapel, M.S., Assistant in Range
 Management

Rural Economics and Sociology

L. A. Moorhouse, M.S., Rural Economist
 R. T. Burdick, M.S., Associate Rural
 Economist
 R. W. Roskelley, Ph.D., Associate Rural
 Sociologist
 A. W. Epp, M.S., Assistant Economist

Seed Laboratory

Bruce J. Thornton, M.S., in Charge
 Helen M. Kroeger, B.S., Seed Analyst

Substations:

Herman Fauber, M.S., Supt., Rocky Ford
 Ferris M. Green, B.S., Supt., Austin
 Dwight Koonce, M.S., Associate
 Agronomist, Fort Lewis

ENGINEERING DIVISION

*N. A. Christensen, Ph.D., Chairman

Civil Engineering

*N. A. Christensen, Ph.D., in Charge
 W. E. Code, B.S., Associate Irrigation
 Engineer
 Adrian R. Legault, M.S., Assistant Civil
 Engineer
 D. F. Gunder, Ph.D., Associate in
 Hydraulics Research
 Maxwell Parshall, B.S., Meteorologist
 Cooperators:
 R. L. Parshall, B.S., Senior Irrigation
 Engineer, U.S.D.A.
 *Carl Rohwer, B.S., C.E., Irrigation
 Engineer, U.S.D.A.

Mechanical Engineering

J. T. Strate, M.S., in Charge
 Ray Barmington, B.S.M.E., Assistant
 Mechanical Engineer
 Cooperators:
 E. M. Mervine, M.E., Agricultural
 Engineer, U.S.D.A.
 A. D. Edgar, B.S., Agricultural
 Engineer, U.S.D.A.

Mechanical Thinning of Sugar Beets¹

E. M. MERVINE²

R. D. BARMINGTON³

MECHANICAL thinning of sugar beets, with a saving of up to nine-tenths of the usual labor for thinning, now is entirely practical. This is feasible now as a result of several years of research which has gradually developed better and better methods of mechanical thinning. This development reached the stage during the 1942 growing season where it was possible to show on a large-scale experimental basis that just as good final yields can be obtained with mechanical thinning as with hand thinning. That this development has come at this time is especially fortunate, for it offers a partial solution to the war-born labor-shortage problem.

In recent months many growers have asked questions about mechanical thinning. These questions have followed a definite outline and it is believed that this bulletin will best serve its purpose by stating these questions and answering them one by one.

Will Mechanical Thinning Work?

In 1942 four methods of thinning sugar beets were carried out in a 30-acre field at Fort Collins. All are more practical on well-prepared seed beds and are successful when every operation is performed on time. The following table shows yield obtained from the various methods as well as the man hours per acre required to carry them out.

	Man hours per acre	Yield in tons per acre
Complete mechanical thinning	2.45	12.24
Modified mechanical thinning plus long-handled hoe.....	11.6	11.40
Long-handled hoe thinning	15.6	11.47
Customary hand block and thin	27.2	12.17

The significant result is that there is no practical difference in yield between the mechanically thinned field and the hand-blocked and thinned field, and the former required less than one-tenth as much labor as the latter.

1. The experiments covered by this report were carried on under a cooperative agreement between the Colorado Agricultural Experiment Station and the Bureau of Agricultural Chemistry and Engineering, Agricultural Research Administration, U. S. Dept. of Agriculture.
2. Agricultural engineer, Bureau of Agricultural Chemistry and Engineering, U. S. D. A.
3. Assistant mechanical engineer, Mechanical Engineering Section, Colorado Agricultural Experiment Station.

What Are the Reasons Behind the Fact That Mechanical Thinning Results in as Good Yields as Hand Thinning?

There are two reasons why mechanical thinning will produce as high a yield as hand thinning. First, since mechanical thinning is faster, all the beets will be thinned "on time." This is an important factor in final yield. Second, sugar beets tend to spread out and use plant food from vacant places or "skips" in the row. The beets on each side of a skip or near a skip in adjoining rows will grow bigger than if the skip was not there, thus, within limits, compensating for missing plants. This is an important factor in final yield and compensates for the greater number of skips and doubles with mechanical thinning.⁴

What Kind of Germination Stand Must I Have for Mechanical Thinning?

It is not true that a "perfect" germination is necessary for mechanical thinning. Germination stands, as distinct from harvest stands, are measured as the number of inches of row that contain beets. Thus in a 40-percent stand, as shown in figure 1, there are 40 inches in each 100 inches in which one or more beets are found. A harvest stand is measured as the number of beets in 100 feet of row.

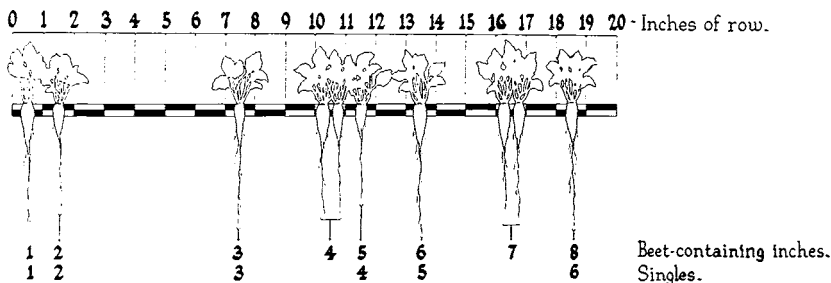

8 beet-containing inches in 20 = 40% germination stand.....

6 singles in 8 hills = 75% singles averaging 3 to 4 singles per foot row....

Germination stands may accurately be estimated by taking about ten 100-inch counts at random in the field.....

Figure 1.

4. This has been shown by research conducted in cooperation with the Colorado Agricultural Experiment Station by H. E. Brewbaker and G. W. Deming "Effect of variation in stand on yield and quality of sugar beets grown under irrigation." Jour. Agr. Res. 50:195-210. 1935.

Germination stands of from 25 percent to 50 percent can be mechanically thinned. Heavier or lighter stands than this both offer difficulties, the heavier stands leaving too many doubles and lighter stands leaving too many gaps in the row.

How Do I Rate My Germination Stand?

To find what your germination stand is, take a lath or a smooth stick 50 inches long and mark it off in 1 inch spaces. Take the stick to the field and drop it down anywhere. Lay the

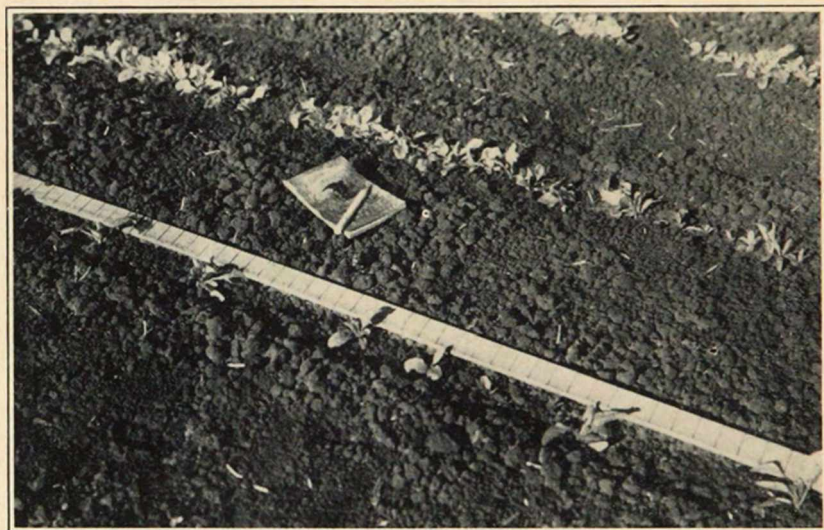

Figure 2.—Three pounds segmented seed per acre in foreground, 18-percent stand—15 pounds whole seed per acre in background 70-percent stand (excellent germinating conditions).

stick beside the row wherever it lands and count the inch spaces which have beets in them the full length of the stick. Whether any inch space has one or half a dozen beets in it makes no difference. If there are 21 beet-containing inches in 50 inches then there will be twice as many or 42 beet-containing inches in 100 inches. This is a 42-percent stand. This should be done at least 10 times at random over the field and the counts averaged to get a good estimate of the whole field.

Must I Plant Segmented Seed for Mechanical Thinning?

It is very desirable but not absolutely necessary. More doubles will result from mechanical thinning when regular seed is used.

What Is Segmented Seed?

Ordinary beet seed balls contain from one to several seeds, each of which will sprout a beet plant when placed in the soil. One whole seed ball may sprout a cluster of beet plants, making thinning to "singles" difficult.

Segmented seed, sometimes called "cracked" seed, is whole seed which has been run through a grinding process in such a way that the seeds have been broken apart or ground down to a fairly uniform segment. This is done as an attempt to have each segment contain only one seed thus being capable of sprouting only one beet. After the grinding process the product is cleaned and screened for size so the remaining segments are free from loose dirt and range from 6/64 of an inch to 10/64 of an inch in diameter. These are single-germ seed balls in approximately 70 cases out of 100. The cracked seed represents only about half the weight of the original seed, but when it is planted at the rate of 7 pounds per acre or less it will plant more acres than the whole seed at the old seeding rates of 16 pounds per acre. The germinating quality is about the same as the original seed, and if cracked seed is placed in the ground as single seeds it will result in single seedlings approximately 70 times out of 100.

Must I Have a Special Planter for Segmented Seed?

No. A reasonably good job of planting segmented seed can be done with the standard flute-feed type of drill, although care will have to be used in working over and adjusting most of these drills to handle segmented seed. To obtain the desired small amount of segmented seed a very small opening of the flute is necessary, and when such a small opening is used a slight difference of one feed as compared with the others makes a large relative difference in the amount of seed planted in one row as compared with the others. It may be necessary to loosen the screws that hold the feed housing and slightly move it or force a washer behind the flute or in some other way cause each flute to deliver the same amount of seed as the others. One of the characteristics of the flute-type drill is to bunch the seed; this is especially noticeable at the small seeding rates on planters which have rather large vanes. This can be overcome by building up the outlet cutoff. A bridge may be made out of a small piece of sheet metal and clipped on the outlet. Many of the fluted-feed planters will need no addition of any kind and may be used to plant the segmented seed with fair satisfaction.

Double Run Feed Type Planters.—These planters have been using the large seed cup side for planting ordinary beet seed

and may be used satisfactorily for segmented seed by using the small side and setting the drive speed to give the desired seeding rate.

Accurate spacing of the seed in the row is obtained only if all planter parts are working properly, and this is especially true of the seed tubes and furrow openers. An accumulation of dust or an obstruction of any sort may cause the seed to lodge and fall off in bunches into the furrow. A disk-type furrow opener is to be preferred to the shoe type because a higher germination is obtained. Calibration of the planter is very important, for only by calibration can it be determined that each opener is delivering the same and the correct amount of seed. Wheel slippage has its effect on the seeding rate and will vary in different seedbed conditions. The final check on the seeding rate can be made by removing all the seed tubes from the openers and tying a paper sack to each. If the planter is a four-row planter with 20-inch rows, it should be driven a distance of 653 feet, with the furrow openers down in working position. It will then have covered just one-tenth of an acre, and the sack on each opener should have in it just one-quarter of the seed desired for one-tenth of an acre. For a 7-pound-per-acre seeding rate one-tenth acre would use approximately 1 quart of seed. If the planter is set for 22-inch rows, the distance to travel is 594 feet for one-tenth of an acre.

Single Seed Ball Planter.—This planter, which will place individual seed balls in the furrow at regular intervals, has been developed as an aid to mechanical thinning. Since a large percentage of sack-run seed balls sprout only single seedlings, the chance of the mechanical thinner to leave individual plants is very much improved over the old plantings where the seeds were, in many cases, placed in bunches. Most of these single seed ball planters are of the plate-feed type and are manufactured by several commercial builders of planters. A still greater improvement in distribution of single plants in the row is accomplished by having the single seed ball planter equipped with plates that will handle segmented seed. In addition to special plates for the segmented seed it is necessary to have special knockers for ejecting the seeds from the plates. The entire change-over to segmented seed is made at small cost and with little effort; also, manufacturers are in a position to make this change on some of the older types of plate-feed planters.

The seeding rate of most planters is regulated by a gear change which speeds up the plate with reference to ground speed. The rate of ground speed also has a definite effect on the seeding

rate of plate-feed planters. At increased speeds the plate does not fill as well as at a slower speed; it is possible to set the machine for a seeding rate of 7 pounds per acre at a ground speed of $2\frac{1}{2}$ miles per hour and plant only 5 pounds per acre by running the planter at a ground speed of 4 miles per hour. It is advisable to plant at the lower speed. There are other factors which affect the seeding rate of a plate-feed planter. The seed, to a certain extent, exerts fluid pressure on the plate so that as the level of the seed in the hopper decreases the pressure on the plate also decreases, with less tendency for the plate cells to fill properly. It is advisable to have the plate well covered at all times to insure proper distribution of the seed. It is also advisable to make sure that there has not been an accumulation of dust between the working parts of the plates and that these parts are fitted closely without binding. These precautions help prevent seed breakage as well as breakage of drive gears. An inspection of these parts several times a day is worth while.

What Seeding Rate Should I Use With Segmented Seed?

In the past it has been the custom to seed at the rate of from 15 to 20 pounds per acre. With segmented seed it is possible to seed at as low a rate as 2 pounds per acre. For many areas it is recommended that 7 pounds per acre be used. Where the beets are to be irrigated up, 5 pounds may be ample; where germinating conditions are nearly ideal, such as in the moist peat soils of California, as little as 2 pounds would give a very desirable stand. In some instances these very low seeding rates might be used without any subsequent thinning being necessary. Many fields planted with 7 pounds of segmented seed will have only a 30-percent germination stand with possibly 65 percent singles, which means that each 100 inches of row will have approximately 20 singles. This stand of approximately 20 singles in each 100



Figure 3.—Segmented seed, 7 pounds per acre, 40-percent germination stand, two-thirds singles.

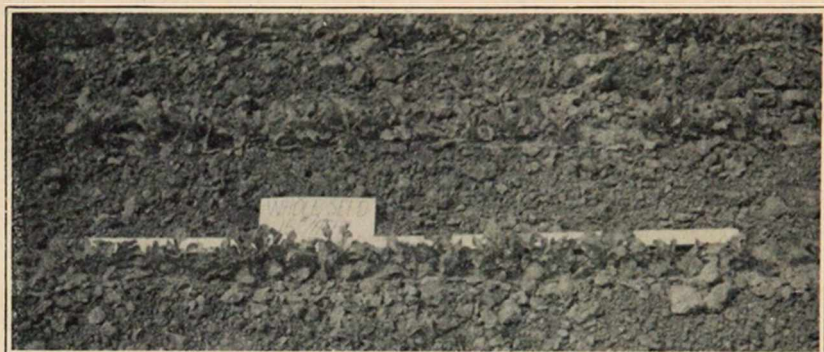

Figure 4.—Whole seed, 16 pounds per acre, 54-percent germination stand, 94 seedlings in 100 inches of row. Such heavy stands make mechanical thinning to singles difficult.

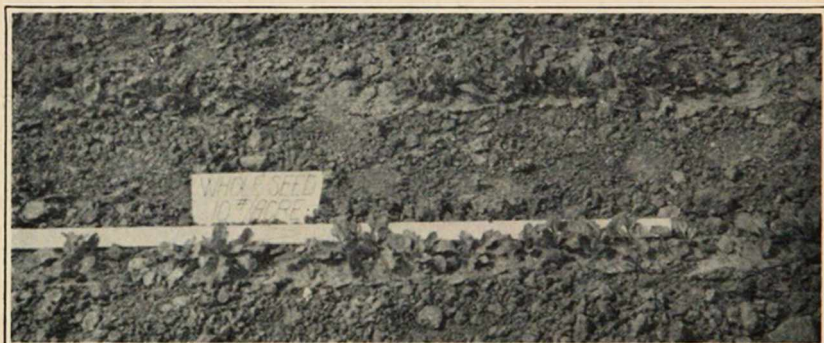

Figure 5.—Whole seed, 10 pounds per acre, 39-percent germination stand, 58 seedlings per 100 inches of row does not yield as many singles as 7 pounds of segmented seed per acre (see figure 3).

inches at first looks very thin but it is, on the average, 1 single each 5 inches of row which is about twice the stand that is desired after thinning. This gives an excellent opportunity for mechanical or long-handled hoe thinning.

What Implements Do I Need for Mechanical Thinning?

There are four systems of mechanical thinning: (1) Mechanical blocking and hand thinning; (2) thinning with long-handled hoe; (3) mechanical blocking and thinning with long-handled hoe; (4) complete mechanical thinning (machine only).

The first method, mechanical blocking and hand thinning, requires 67 percent of the time of present hand methods. The second, thinning with long-handled hoe, requires 70 percent of the time of present hand methods. The third method, mechanical blocking and thinning with long-handled hoe, requires 40 percent

of the time of present hand methods. The fourth method, complete mechanical thinning, requires only 11 percent of the time of present hand methods.

The only implements required for these methods are: For methods 1 and 4, a beet cultivator equipped with special knives; for method 2, a long-handled hoe; and for method 3, the beet cultivator with special knives and a long-handled hoe.

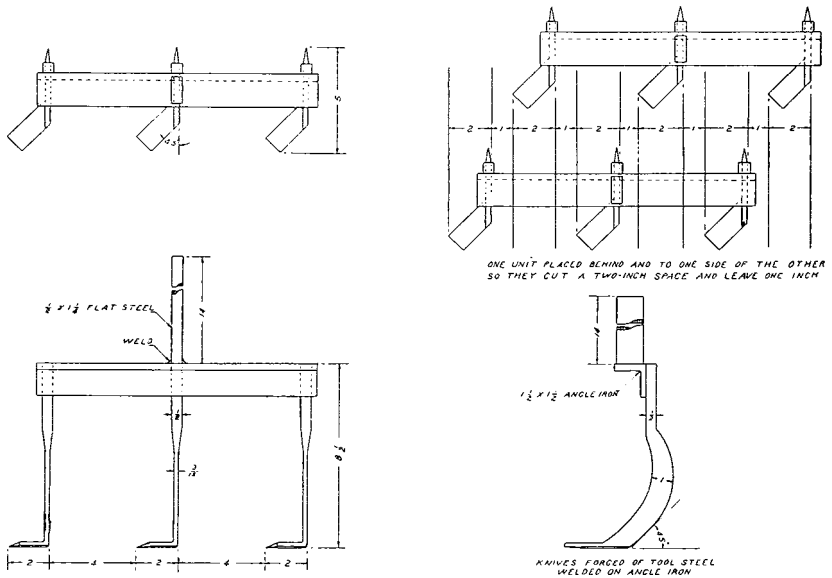

Figure 6.—Mechanical thinning tools may be made by the local blacksmith with dimensions varied to suit the grower.

The type of cross-blocking knife used is not vital. There are, however, a few basic qualities the knife should have, such as its ability to slide through the soil with a minimum of soil movement and its ability to clean itself of trash and roots. For the grower who plans to build a set of special cross-blocking knives the type shown in figure 6 is suggested with dimensions changed to fit the particular size desired. Most growers will have some worn-out cultivator sweeps which may be cut down to the proper width and used to cross-block by simply spacing them the desired distance apart on the tool bar. It is usually desirable to have half the knives on the front tool bar and half on the rear, alternately spaced, to allow more clearance between knives. When this plan is used it will be necessary to have an extra number of clamps on hand.

When mounting cross-blocking tools, the grower should have the cultivator on a smooth floor or on a smooth place in the yard

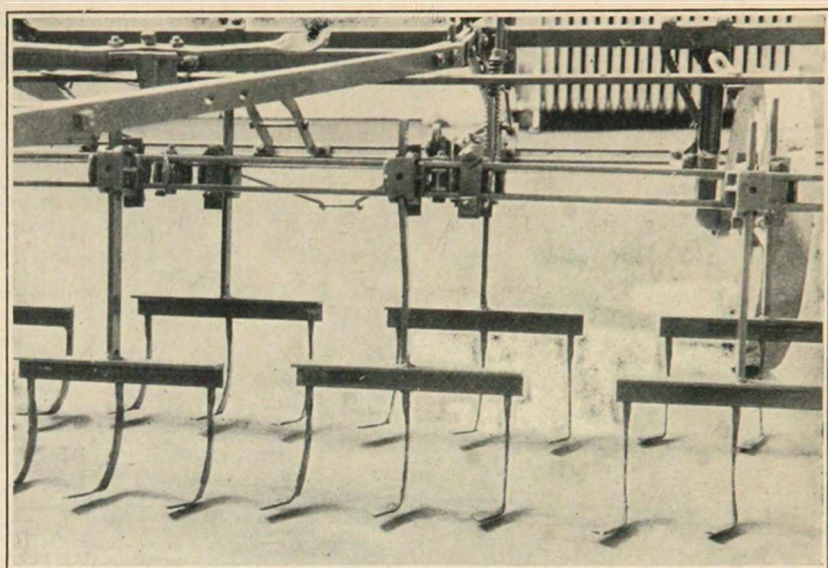

Figure 7.—Mechanical thinning tools of small block size may be mounted on the cultivator.

with a board or plank under the knives so they will all be set at the same depth. This will also help in checking the space between knives. First a blocking knife should be placed directly behind the wheels; then the remaining space should be divided as well as possible. It is probably more important to pay attention to accurate spacing than to the wheel marks if there is difficulty in getting both. A gauge marker, while it is not necessary, may be used. When crossing the field, it is better to skip a space than to lap over.

How Do I Go About the Mechanical Thinning Operation?

System 1. Mechanical **blocking** is familiar to most beet growers. It is merely cultivating across the rows with the knives on the cultivator set to cut out portions of the beet rows as it goes across them. This then is followed by the customary hand thinning. Mechanical **thinning** may be accomplished with varying degrees of labor saving, depending on field conditions as follows:

System 2. In thinning with a long-handled hoe the thinner cuts out beets at more or less regular intervals, leaving singles as often as possible without stooping. This system is best adapted to use in a field where the germination stand is less than 25 percent or is too poor to warrant mechanical blocking.

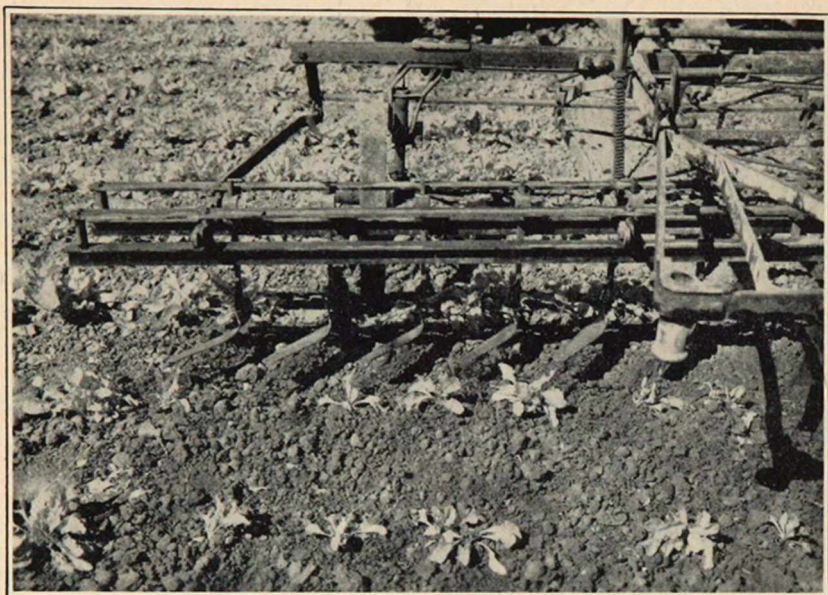

Figure 8.—Ordinary cultivator knives may be cut to proper width and spaced as desired.

System 3. The beet cultivator with the knives described as before is run across the rows. Then the laborer with the long-handled hoe goes through and chops excess beets, again leaving singles wherever possible without stooping.

System 4. In mechanical thinning without the use of any type of hand labor, the knives on the cultivator are set to leave only small blocks in the beet row and the cultivator is run across the rows just as in mechanical blocking.

In method 1 (mechanical blocking and hand thinning) approximately two-thirds of the row is cut out, but in method 4 (complete mechanical blocking) about three-fourths of the row is cut out and the remaining blocks are only 1 or 2 inches wide. The object is to block to a final stand so that there will have to be no further thinning. When this is done the field looks as if it were ruined. A plant count 2 days later will tell a different story.

From figure 9 it can be seen that if a 40-percent germination stand is cross-blocked with a 4-inch knife leaving 2-inch blocks there will be left approximately 115 beet-containing blocks per 100 feet of row. If the same stand is blocked with 2-inch knives leaving 1-inch blocks there will be approximately 150 beet-

containing inches left per 100 feet of row. This chart has been satisfactorily used as a guide to determine the size of knife and block to use after the germination stand has been determined. Figure 9 shows the number of blocks left per 100 feet of row for germination stands ranging from 15 to 60 percent, irrespective of the number of beets in the block. It is usually impractical to wait until after germination stand counts are obtained to make cross-blocking equipment, and as an all around blocking tool the 4-inch knife leaving a 2-inch block has been found most satisfactory.

There is always a strong tendency to leave too many beets rather than too few. If the grower has a 30-percent germination stand and has blocking equipment to cut out 4 inches and leave 2 inches, then as is shown in figure 9 he can expect to leave 90 or 95 beet-containing blocks per 100 feet of row. After a round has been made with the cross-blocking equipment the field looks as if everything is torn out. Many of the spaces left will be blanks and quite often the knife will take out the only beet in several inches of row, leaving long skips. However, a count a day or two later will show that the proper number of beets per 100 feet of row has been left. Some of the skips may be 2 feet or more in length, in which case it is necessary when trimming up with a hoe to leave some beets only 6 inches apart. Some of the beets left will be doubles. Results of large-scale experiments at

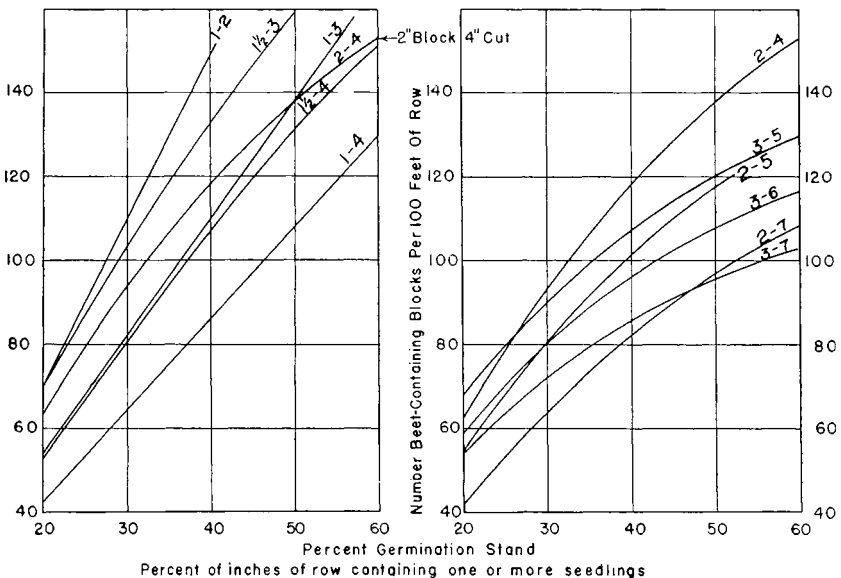

Figure 9.



Figure 10.—The thinning period may be extended without loss because earlier mechanical blocking eliminated excessive beet competition.

the Colorado Agricultural Experiment Station show that this type of stand will not suffer in yield or sugar content. It has been observed that a few doubles in the final stand will not hurt. Some of the multiples left in bunches at thinning time will be choked out before harvest. Even though timeliness is very important, it may be well to make a round or two cross blocking and then wait a couple of days to see how many beets are left.

Row Blocker.—In areas where it is the practice to plant beets on beds or where thinning has been delayed until beets and weeds have made considerable growth it may be more desirable to use a row blocker. The revolving motion of the cutter will help to throw off trash and weeds in fields where the stationary cross-blocking knife might clog. The knives on row blockers can be adjusted to various sizes of cuts and blocks, and the distance between blocks can be changed by changing the size of the drive sprockets.

How Much Labor Can I Save by Mechanical Thinning?

The amount of labor required for ordinary hand blocking and thinning operations varies greatly with the ability of the

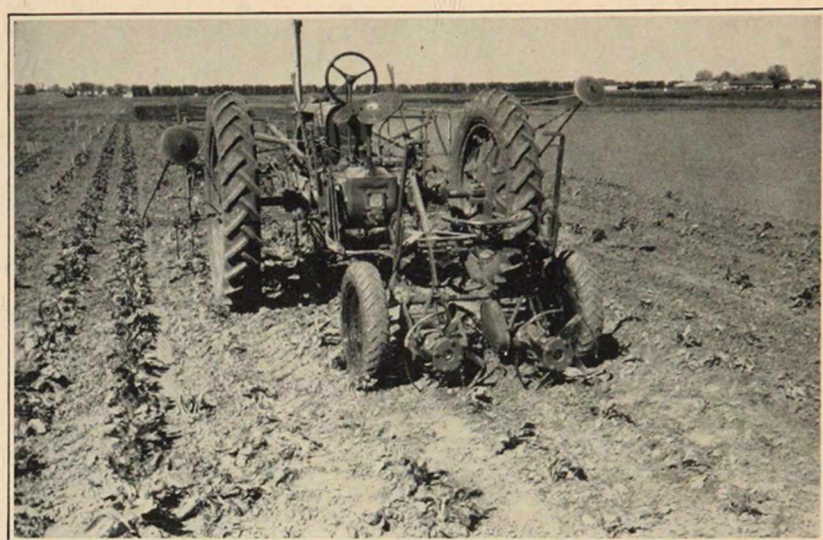

Figure 11.—Row blockers are adjustable for various sizes of cuts and blocks.

laborer, some requiring more than twice as much as others. The same is true with the amount of time required with mechanical methods. The following table shows the average time in man hours required for the different systems of thinning and is the result of 9 years of study at the Colorado Agricultural Experiment Station.

	Man hours per acre
Hand block and thin	23.34
Mechanically block and hand thin	15.96
Mechanically thin followed by long-handled hoe	9.55
Long-handled hoe only	16.2
Machine only (mechanically thin)	2.55

During the 1942 season a very extensive study was made on the different systems of mechanical thinning in comparison with the usual hand method. The plots were each 40 feet wide and 1 acre in extent. Every alternate plot had the same treatment so that all the plots could then be compared with each other. The plots were large enough so that accurate time studies could be made of the laborers' ability to do the work. The same labor crew worked the entire field.

The amounts of labor time necessary for the different systems shown in figure 13 are just about the same as shown in the foregoing table, the results of previous years studies.



Figure 12.—Row blockers may be used in heavy growth of beets or weeds.

Figure 13 shows that population of beets left after the thinning operations is approximately the same for the different methods of thinning, but more noticeable is that the harvested marketable beets are nearly the same. Apparently the number of multiples left at thinning time was reduced at harvest time by having most of the small beets choked out, allowing the marketable beet to grow to its full size.

The primary objective of mechanized sugar beet production is to save labor. As shown in figure 13 the labor required to thin an acre of beets at the Colorado Agricultural Experiment Station in 1942 ranged from 27.2 man-hours for hand labor to 2.45 man-hours for the most complete machine thinning. Other combinations of machine and long-handled hoe work ranged between the two extremes.

A compromise system of cross-blocking, such as the 4-inch knife and 2-inch block followed by a laborer using a long-handled hoe, will save an appreciable amount of thinning labor and at the same time increase the length of the thinning season without suffering loss of yield. If the cross-blocking is done as soon as the beets are big enough to prevent covering the remaining blocks, the competition in the row is eliminated before it can do any damage. Experiments have shown that if the blocking is drastic enough the long-handled hoe thinning can be delayed until the

Yardstick incorporated in each picture. Picture taken at center of each plot. Plots 1 acre in extent.













	Method of blocking and thinning Width of knife & width of block	Labor involved Man hours per acre	After-thinning stand		Harvest stand Beets per 100' row		Relative yield expressed as percentage Differences not statistically significant
			Hills per 100' row	% singles	Market-able	Unmarketable	
	4" 2" followed by laborer with hoe-check plot.	11.6	99.6	74 %	108.25	14.7	93. %
	4" 2" followed by delayed hoe.	11.7	88.3	69 %	97.75	11.0	94.6 %
	4" 2" plus hoe check plot.	11.6	92.6	69 %	105.25	13.5	93. %
	2" 1" plus hoe	13.5	90.3	70 %	101.5	10.75	98. %
	4" 2" plus hoe-check plot	11.6	93.4	67 %	102.0	14.5	93. %
	Hand block and hand thin.	27.2	108.8	95 %	100.25	3.75	99. %
	4" 2" plus hoe-check plot.	11.6	87.7	68 %	103.0	11.0	93. %
	Hoe only.	15.6	97.7	62 %	116.0	13.25	94. %
	4" 2" plus hoe-check plot	11.6	87.5	67 %	103.5	11.75	93. %
	Machine only 3" 1"	2.45	82.7	64 %	109.5	15.5	100 %
	4" 2" plus hoe-check plot.	11.6	83.1	66 %	96.75	12.25	93. %
	Machine only 3" 1"	2.45	84.6	62 %	116.75	13.0	100 %

Figure 13.—Results of large scale trials of mechanical thinning.

first weed hoeing, at which time the excess beets are considered weeds and treated accordingly. On plots 10 and 12, figure 13, this system was followed. The time required for the cross blocking operation was .45 man-hours per acre. Then at hoeing time it took approximately 2 man-hours per acre to cut out the excess beets in addition to the time required for weeding. This extra 2 hours was charged to thinning time, making a total of 2.45 man-hours per acre for the complete thinning operation. Although differences in yield on all 12 plots are not statistically significant, the highest yields were obtained on plots 10 and 12 where the least thinning labor was used.

On plot number 8 the long-handled hoe was used without any cross blocking and without any finger thinning, the final stand being left by the laborer using a hoe only. This plot required 15.6 man-hours per acre to thin, as compared to 11.6 man-hours where cross blocking was followed by a long-handled hoe. The laborer using a hoe left only 62 percent singles, which is less than he left following cross blocking, even though he had a much greater choice of single plants in the row to choose from. It seems that the average laborer with a hoe soon becomes mechanical in his motions and is no more selective than the machine. The 30-acre field in which these 1-acre plots were located was planted with 7 pounds of segmented seed per acre, which gave a 40-percent germination stand. If the germination stand is 25 percent or less it may be hazardous to cross block, and in this case the use of the hoe only may show up to a greater advantage in obtaining the desired population and distribution.

NOTES

COLORADO AGRICULTURAL EXPERIMENT STATION
COLORADO STATE COLLEGE
FORT COLLINS

—
FREE BULLETIN

Homer J. Henney, Director

POSTMASTER:—If not at address, please check and return. No postage required; stamp name of your office plainly.

Deceased Address Unknown

Correct Address _____

See Sec. 493, Postal Laws and Regulations

Penalty for private use to avoid
payment of postage, \$300