

COLORADO DIVISION OF WILDLIFE  
**Aquatic Nuisance Species (ANS)  
Watercraft Decontamination  
Manual**





**STOP AQUATIC  
HITCHHIKERS!™**

*Note:*

We do not endorse any products or brands  
pictured or mentioned in this manual.

# Table of Contents

Why watercraft decontamination? .....	2
When will decontamination be required? .....	2
What does watercraft decontamination generally consist of? .....	2
What types of decontaminations will I do? .....	3
Where should watercraft decontamination stations be located? .....	4
When should a portable water containment pad be used? .....	4
What are the requirements for a decontamination unit? .....	4
What are the standard operating procedures for a decontamination unit? .....	5
• <a href="#">Step-by-Step Operating Instructions for Trailered HydroTek Decontamination Units</a> .....	5
• <a href="#">Step-by-Step Operating Instructions for Trailered Mi-T-M Decontamination Units</a> .....	7
What is included in the standard decontamination protocols? .....	9
What is the protocol for standing water decontamination? .....	10
• <a href="#">What are pump temperature ratings?</a> .....	11
• Examples of live well and aerator pump diagrams .....	12
• <a href="#">Step-by-Step Procedure for Standing Water Decontaminations</a> .....	13
• Interior Compartments .....	13
• Outboard Motors and Inboard/Outboard Engines .....	14
• Inboard Engines and their Bilges .....	16
• Ballast Tanks .....	18
What is the protocol for plant decontamination? .....	20
• <a href="#">Step-by-Step Procedure for Plant Decontamination</a> .....	20
What do the regulations say about live aquatic bait? .....	22
What is the protocol for live aquatic bait treatment? .....	23
• <a href="#">Step-by-Step Procedure for Bait Treatment</a> .....	20
Full Decontamination for Suspect or Confirmed Mussels or other ANS .....	26
• <a href="#">Step-by-Step Procedure for Full Decontamination</a> .....	28
Step-by Step Procedure for Malibu Wakeboard Boats .....	33
What if the boater will not allow an inspection or decontamination? .....	36
What options does the boater have if the decontamination unit is broken or if our station doesn't have a decontamination unit? .....	36
State Standard Forms .....	36
• High Risk (ANS) Inspection Form .....	37
• (ANS) Documentation and Vessel Decontamination Form (page 1-4) .....	38
• Inspection and Decontamination Green Seal Receipt .....	42
• Watercraft Inspection And Decontamination Activity Log .....	43
Winterizing Procedures for Decontamination Units: .....	44
• <a href="#">Step-by-Step Instructions for Trailered HydroTek Units</a> .....	44
• <a href="#">Step-by-Step Instructions for Non-Trailered HydroTek Units</a> .....	47
• <a href="#">Step-by-Step Instructions for Mi-T-M Units</a> .....	49
Decontamination Unit Photo Glossary .....	52
Acknowledgements .....	Inside back cover

## Why watercraft decontamination?

Invasive species, such as zebra or quagga mussels, are able to travel great distances over land by “hitchhiking” on watercraft. They can survive up to 30 days out of water depending on temperature and/or humidity. Through a comprehensive education, inspection and decontamination program, we can stop the spread of these costly invasives in Colorado and the West. Once detected on watercraft, zebra or quagga mussels and other aquatic nuisance species (ANS) can safely and effectively be killed and removed from the watercraft by certified personnel.

The State of Colorado protocol requires the use of hot water with high or low pressure to decontaminate boats, motors/engines, trailers, personal gear, and other equipment. The objective of decontamination is to **kill** and **remove**, to the extent practical, all visible mussels or suspected ANS. Killing ANS prevents establishment of new populations as a result of watercraft/equipment transfer.

## When will decontamination be required?

Most inspections will not result in a decontamination being performed. In fact, less than 1% of inspections resulted in decontamination in both 2009 and 2010.

However, there are many different circumstances that may result in a decontamination being performed:

- If zebra or quagga mussels are found attached to a watercraft.
- If any other ANS is positively identified or suspected on a watercraft.
- If suspect unidentifiable bumps are detected on a watercraft.
- If the watercraft is from a positive or suspect water and has any water in it.
- If the watercraft has more than **five** gallons of standing water in it after draining.
- If the watercraft has more than **two** ballast tanks with unverifiable water in them.
- If the watercraft is unable to be fully drained.
- If the watercraft or trailer has plants attached that can't be removed by hand.
- If the watercraft has live aquatic bait without a valid receipt.
- If the inspector deems a decontamination is necessary.

## What does watercraft decontamination generally consist of?

Watercraft decontamination consists of a very hot water rinse or spray at high or low pressure. There are no soaps, bleaches or chemicals used or recommended at this time. The hot water kills the mussels and other ANS, and the high pressure spray removes them from the watercraft.

The general recommendation is to use 140°F water at high pressure (2,500 psi) to decontaminate the hull and 140°F water at low pressure to decontaminate motors/engines. Interior compartments are decontaminated with 120°F at low pressure to avoid damaging pumps.

The graph below tells us that a 140°F (60°C) hot water rinse for ten seconds to each spot will kill all adult mussels. A 176°F (80°C) rinse for five seconds to each spot will kill all adult mussels. However, higher temperatures are not recommended for the protection of the watercraft.

This graph shows the relationship between hot water temperature, time of rinse and survival probability of adult mussels.

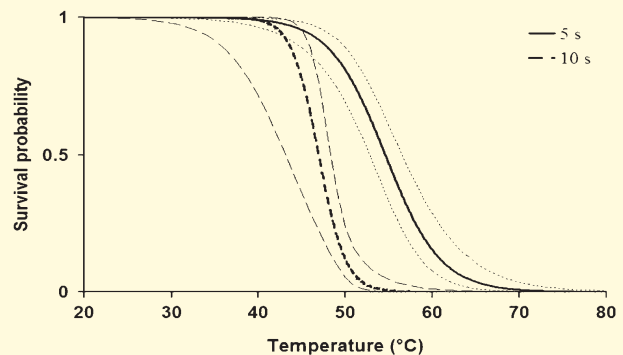

Morse, John T.(2009) 'Assessing the effects of application time and temperature on efficacy of hot-water sprays to mitigate fouling by *Dreissena polymorpha* (zebra mussels Pallas)', *Biofouling*, 25:7, 605-610

The following graph shows that there was 0% survival of quagga mussel veligers in water temperatures of 95°F (35°C). Therefore, the reduced temperature of 120°F for interior compartment standing water decontaminations for the protection of the watercraft is more than sufficient to kill veligers in those interior compartments. This research also reinforces the importance of standing water decontaminations for boats leaving positive waters, even if no adults or settlers are found on the vessel, because it shows that veligers can live in standing water for up to



24 days at 50°F (10°C), 8.5 days at 59°F (15°C) or 4.5 days at 86°F (30°C).

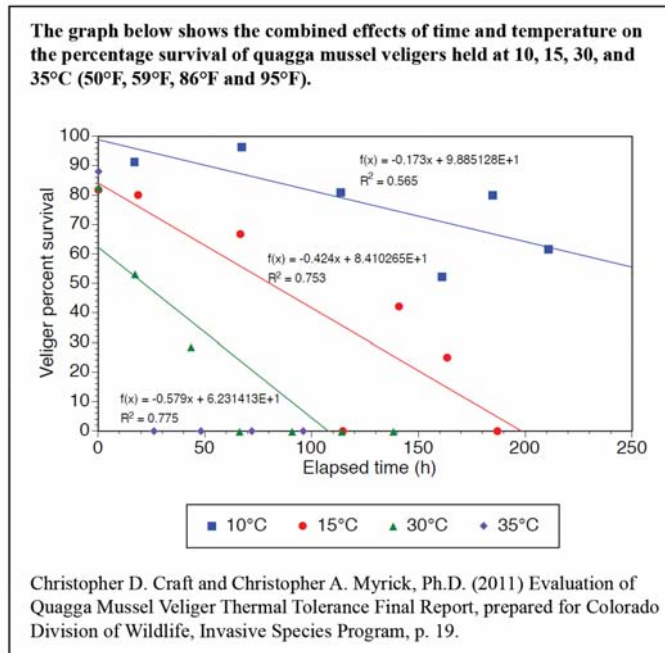

## What types of decontaminations will I do?

There are four different types of ANS decontaminations. Each of these will be described in great detail later in the manual.

Decontaminations performed must be documented on the *Watercraft Inspection And Decontamination Activity Log* under the “Results” headings (See page 43).

### Standing Water Decontamination

This protocol is performed to kill veligers or other microscopic ANS in standing water that can’t be fully drained from the watercraft. This decontamination applies to interior compartments that contain water or have equipment that have come in contact with the water body. The interior compartments include but are not limited to: live wells, bait wells, bilge areas, and ballast tanks. The equipment includes but is not limited to: anchor, mooring and anchor lines, PFD’s, swim platform, inflatables, down-riggers, planning boards, water skis, wake boards, ropes, ice chests (used for bait or for holding fish), fishing gear, bait buckets, and stringers. Standing water decontamination also includes flushing the outboard motor, inboard/outboard engine, or inboard engine of a watercraft.

Standing water decontamination is mandatory:

- If the watercraft is from a positive or suspect water body and has any water in it.

- If the watercraft has more than five gallons of standing water in it after draining.
- If the watercraft has more than two ballast tanks with unverifiable water in them.
- If the watercraft is unable to be fully drained and the water can’t be sponged, towed or pumped out.

The standing water decontamination protocol requires that pump temperature ratings are taken into account when flushing or rinsing a compartment for standing water. Some, but not all, marine pumps are rated to withstand temperatures above 140°F. If the pump is rated to a lower temperature and is flushed with 140°F water, damage could occur. For this reason, the protocol requires turning the temperature down to 120°F for all interior compartment flushes or standing water decontaminations.

### Plant Decontamination

This decontamination is performed whenever plant material cannot be removed from the watercraft or trailer by hand. This decontamination is localized and only requires using 140°F hot water on the areas where plant material is located.

### Bait Treatment

This decontamination prevents the potential transfer of ANS in water found in a bait well or bucket. Strict step-by-step procedures must be followed if the bait receipt is older than seven days. If the bait is from out of state, the bait is not permitted and must be disposed of in the trash. If the boater has no receipt, follow the protocol found on pages 22–25.

### Full Decontamination for Suspected or Known Mussels or Other ANS

This protocol is performed when adult or settler mussels, unidentifiable bumps or other ANS are detected on the watercraft. This decontamination is the most complicated and ensures that the boat has been completely decontaminated inside and out. The inspector must complete a high risk inspection form prior to and after the decontamination, in addition to the four-page (*ANS Documentation and Vessel Decontamination Form*) (See pages 38–41). The inspector must take photos and samples for identification prior to doing a full decontamination.

In rare instances, you may require the assistance of law enforcement personnel to decontaminate or impound a boat. A few of the situations that would require a qualified peace officer to assist include an uncooperative boat owner, an unavailable or broken decontamination unit, or instances in which an inspector simply can’t get a fully encrusted watercraft decontaminated in one day. See page 35 for more information.

## Where should watercraft decontamination stations be located?

Ideally, watercraft inspection, draining, and decontamination should be located in the same general area. The location should be far enough from the water or boat ramp that drained bilge/ballast/well water and water from the decontamination unit cannot flow into the water body. This site is ideally on an access road where all boats must pass prior to launch and after exiting the boat ramp. The site should be far enough away from the ramp to allow users, especially overnight campers, to move through the interior of the state wildlife area or park without going through the inspection and decontamination station unnecessarily.

Decontaminations should be conducted “high and dry,” away from the water. The minimum requirements for decontamination unit placement include:

- Must be in a location where the water does not run off into the reservoir or lake.
- Must be on semi-permeable surface (gravel or dirt) where water absorbs into the ground or evaporates off.
- Must be in a location where the inspector can maintain visual and auditory contact with the inspection station (which in many instances is the boat ramp but not always).
- Must be in secure facility where the decontamination unit is locked up over night or when inspectors are not present.
- Must be protected from the elements—rain, wind, excessive cold.

Assuming that local rules are not stricter, decontamination stations are not required to collect and treat their wash water prior to disposal if they meet the provisions set forth in the Colorado Department of Public Health and Environment Water Quality Control Division policy titled; “Power Washing Operations” in addition to Water Quality Protocol 27. Essentially the policies require the following:

- Power washing operations must be conducted where the wash water does not include soaps, bleaches, and chemicals.
- Wash water effluent must not enter state waters, therefore the power washing operations must be located in a flat gravel area where water will seep into the ground without ponding.

## When should a portable water containment pad be used?

If a suitable site (high and dry, away from the water source, and on a semi-permeable surface) is not available, you will be required to use a water containment pad to ensure waste water is collected and properly disposed of.

If using a portable water containment pad, follow the protocol below for set up:



© AIRE INDUSTRIAL

### Roll out containment pad

- 1—Note how the pad is rolled up, so you can fit it back in the bottom bunk of the trailer.
- 2—Set up the waste collection pad so that the driver can drive straight on, without excessive wheel turning.

3—Ensure drainage to the waste water pump location on pad.

4—Ensure the waste water pump location is close to trailer.

### Set up air pump

- 1—Connect the air pump to the battery.
- 2—Turn on the air pump to inflate the outer rim of pad quickly.
- 3—Remove the air pump and store it in the trailer.

### Set up waste water pump

- 1—Put a small rock or piece of wood under one side of the pump to keep the pump from sucking up the mat.
- 2—Plug waste water pump into outlet on the side of the trailer.

Run the hose from pump into waste water recovery tank (or to drain area if not using tank)

## What are the requirements for a decontamination unit?

- Adjustable temperature ranging from between 120–140°F
- Minimum flow of five gallons per minute
- Preferred pressure of 3,000 psi (minimum 2,500—maximum 3,500)

# What are the standard operating procedures for a decontamination unit?

Be sure to follow the manufacturer's operating procedures specific to your unit.

## Step-by-Step Operating Instructions for Trailered Hydro Tek Decontamination Units

### Before start up

1—**Check pump oil.** Check pump oil by locating the yellow oil dip stick on top of the pump.



2—**Check fluid levels.** Check engine oil by locating the yellow dip stick on the engine. Check gasoline and diesel fuel levels in the tank.



3—**Roll out the hose** and double check all quick connects.

4—**Connect the water supply and turn water on.** Maintain an adequate supply of water using a 3/4 inch I.D. hose with a pressure between 25 and 60 psi. Burner power switches should be off before starting. If the decontamination unit is tank fed, be sure there is water in the tank and valve is switched for supply tank feed. **Do not run dry.**

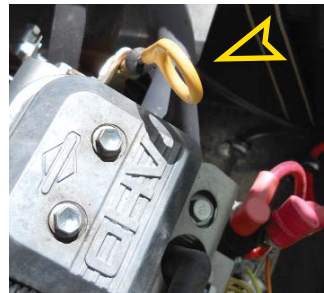

### Operation

1—**Starting.** Pull out choke and turn the key to start position only until engine starts. Push the choke in immediately after engine starts.



2—**Purge air from system.** Squeeze the trigger on the spray gun until a constant stream of water comes out. (Purging works best with the nozzle removed from the wand and/or dual wand in the low-pressure mode).

3—**Select desired nozzle.** Connect a 40° nozzle securely to the spray wand. Hold the gun firmly, squeeze the trigger for high-pressure spray. See page 54 for nozzle descriptions which vary by manufacturer. **CAUTION: gun kicks back—hold with both hands.**





## Step-by-Step Operating Instructions for Trailered Hydro Tek Decontamination Units (cont.)

4—**Start the burner.** To create hot water on high pressure washers equipped with heat exchangers, release the trigger on the gun, turn the burner to the “on” position, and turn the thermostat to the desired temperature.

Squeeze the trigger on the spray gun and the burner will begin heating the water. The burner will stop heating the water whenever the water spray is off or if the temperature setting is exceeded.

Be sure to test the water temperature prior to decontaminating to ensure you are working at the correct temperature for that procedure (either 140°F or 120°F).

5—**Bypass mode.** System will go into bypass mode when the machine is left running and the trigger gun is released. Bypass mode is when the inlet water coming into the pump re-circulates through the unloader across the pump head. If left in bypass too long—more than five minutes—friction created by the movement of the water will begin to heat the water at a rapid rate. If equipped with a bulk water tank, water can be bypassed back through the tank allowing for a larger volume of water to be re-circulated through the pump head, thus reducing heat on the pump seals.

**WARNING:** Do not leave in bypass for longer than five minutes to prevent the pump from overheating. Shut off the unit when not spraying water.

6—Perform appropriate decontamination protocol.

### Shut down

**WARNING:** Cool down the burner before shutting off the decontamination unit.

- 1—Turn the burner switch to the off position.
- 2—Squeeze the trigger on the spray gun until the water becomes cool.
- 3—Turn the engine switch off.
- 4—Turn off water supply.
- 5—Squeeze the trigger to release any trapped pressure in discharge hose.
- 6—Drain water out of the hose and roll up.
- 7—Disconnect attachments and store properly.

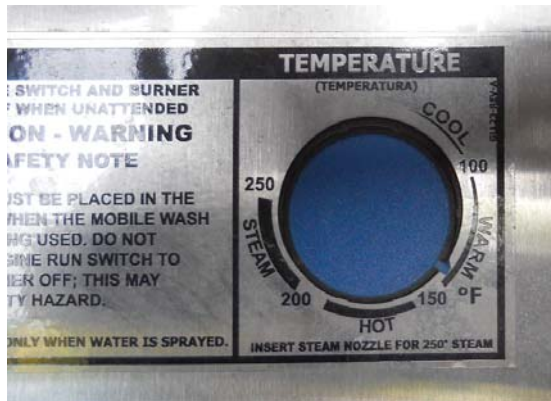



# Step-by-Step Operating Instructions for Trailered Mi-T-M Decontamination Units

## Before start up

1—Check pump oil and engine oil.

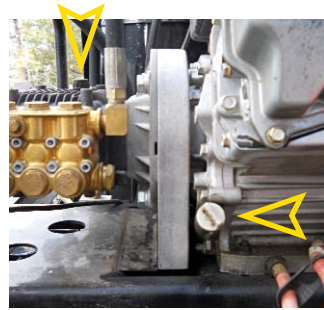

2—Check fluid levels of diesel and gas.



3—Roll out the hose and double check all connections.

4—Check the water level, water filters, and supply valve. The water filter is to the left of the red valve and the water supply valve is turned off. Make sure the water supply valve is off when checking both water filters. Unscrew the green cap to access the internal water filter.



## Operation

1—Cold start.

- a. Turn on the red engine switch (located on the top right hand side of the engine).



- b. Turn on the gas line lever (located to the left of the engine).



## Step-by-Step Operating Instructions for Trailered Mi-T-M Decontamination Units (cont.)

c. Activate the choke by pushing it to the side  
(located above the gas line lever).



d. Pull start the engine. Make sure the trigger on the  
spray gun is on.



e. Once the engine starts, turn off the choke.

**2—Purge air from system.** Squeeze the trigger on the  
spray gun until a constant stream of clear water comes  
out.

**3—Start the burner.** To create hot water on high  
pressure washers equipped with heat exchangers, release  
the trigger on the gun, and turn the burner to the  
“on” position.



Squeeze the trigger on the spray gun and the  
burner will begin heating the water. It will stop firing  
whenever the water spray is off.

Be sure to test the water temperature prior to  
decontaminating to ensure you are working at the correct  
temperature for that procedure (either 140°F or 120°F).



**4—Bypass mode.** System will go into bypass mode when  
the machine is left running and the trigger gun is released.  
Bypass mode is when the inlet water coming into the  
pump re-circulates through the unloader across the pump  
head. If left in bypass too long—three minutes—friction  
created by the movement of the water will begin to heat  
the water at a rapid rate.

**WARNING: Do not leave in bypass for longer than three  
minutes to prevent the pump from overheating. Shut off  
the unit when not spraying water.**





## Shut down

**WARNING:** Cool down the burner before shutting off the decontamination unit.

- 1—Turn the burner switch to the off position.
- 2—Squeeze the trigger on the spray gun until the water becomes cool.
- 3—Turn the engine switch off.
- 4—Turn off gas supply line.
- 5—Turn off water supply.
- 6—Squeeze the trigger to release any trapped pressure in discharge hose.
- 7—Drain water out of the hose and roll up.
- 8—Disconnect attachments and store properly.



## What is included in the standard decontamination protocols?

To ensure that zebra and quagga mussels and other ANS are killed and removed, watercraft decontamination protocols include:

### Safety!

Ensure staff and the public's safety by wearing all personal protective equipment, taking care to avoid slips, trips, falls, and burns. Use caution when operating the high pressure spray wand.

### Education

Explain to the boater why decontamination is important and why we are doing it. You can direct them to the decontamination page of the *Boaters Guide to ANS Inspections* brochure and have them read it in a safe location while you perform the decontamination.

### Removal

All mud, plants, water, and organisms must be removed from the vessel.



## Decontamination

Thoroughly spray the exterior and flush the interior compartments of the watercraft with hot water.

- The exterior of the watercraft and trailer must be thoroughly decontaminated with **140°F** water at **high pressure** (minimum 2,500 psi) when appropriate.
- All interior compartments that may hold water, including, but not limited to: live/bait wells, ballast, bilge areas and intakes must be flushed at **low pressure** with **120°F** water.

*Note:* Low pressure can be achieved with the wand by removing the nozzle and turning the handle away from you.

- All discharge ports must be flushed with 120°F water at **low pressure** for one minute.
- If a bilge pump is present, then it must be run until the bilge appears to be empty.
- The lower unit of the engine should be thoroughly flushed with 140°F water at **low pressure** until exiting water temperature is 140°F.



When doing a full decontamination for suspect or known ANS, be sure to take photos, samples, and do a high risk inspection both before and after the decontamination (See pages 26–31).

## Bait

Depending on the location and type of live aquatic bait, the inspection or treatment will vary (See pages 22–25).



## Report

Inspectors must report all full decontaminations by emailing [ReportANS@state.co.us](mailto:ReportANS@state.co.us). In addition, mail a copy of the four-page (ANS) *Documentation and Vessel Decontamination Form*, two *High Risk (ANS) Inspection Forms* and all photos to:

Colorado Division of Wildlife  
Attn: Invasive Species Coordinator  
6060 Broadway, Denver, CO 80216

All other decontaminations are documented on the *Watercraft Inspection And Decontamination Activity Log*.

## Green Seals

If the boat is leaving your site following the decontamination, apply a green inspection seal and give the boat operator an *Inspection and Decontamination Seal Receipt* (See page 42). If you did a full decontamination, also provide the boater with the pink copies of the *High Risk (ANS) Inspection* and four-page (ANS) *Documentation and Vessel Decontamination* forms to document the decontamination (See pages 38–41).

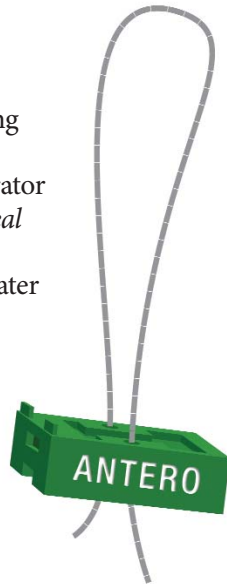

ILLUSTRATIONS BY COLORADO STATE PARKS

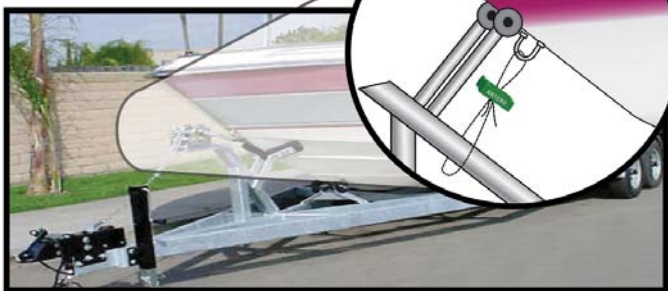

# What is the protocol for standing water decontaminations?

Zebra and quagga mussels start off life as microscopic, free-floating organisms called veligers that are too small to see with the naked eye. They can be transported to new locations in standing water in live wells, bilge areas, and other interior compartments on boats. Mussels aren't the only unseen invasive species. Others, such as the spiny water flea, are also microscopic and transported in the water from the lake or reservoir. Small plant fragments that get sucked up in water onto the boat could start a new infestation in another lake. To prevent the overland movement of invasive species through standing water on boats, the lake or reservoir water must be fully drained out of the boat in between each use. If the standing water cannot be fully drained, the compartment needs to be decontaminated.

This protocol is used to force infested water out of the boat while killing veligers and other ANS in the water. The water must reach 120°F coming out of the boat. The high pressure wand is almost never used in this protocol.

If boats have been drained to the fullest extent possible and still contain standing water in the bilge, ballast tanks, live/bait wells, or engines, then you will need to follow the rules below to determine if decontamination is required.

- If a boat has been in a positive or suspect water in the last 30 days and has any water (this includes the engine when it is lowered); it is **mandatory** to perform a standing water decontamination. The interior compartments or engine that contain standing water must be flushed to ensure ANS are not moved into the next water body.
- If a boat has **five** or more gallons of water after it has been drained, then it is **mandatory** to perform a standing water decontamination, even if there is no evidence that the boat has been in positive or suspect waters. The interior compartments/tanks must be flushed to ensure the water is decontaminated.
- Boats with more than two ballast tanks will require standing water decontamination. Because the tanks contain unverifiable water and draining is impossible due to the placement of the drain opening (typically on the side wall) each tank has the potential to hold two or more gallons of water after draining. Therefore, if a ballast boat has more than two tanks, the total for the boat is more than five gallons so all of these tanks **must** be decontaminated (See page 18 for ballast procedures).



- Colorado protocol requires that a boat must be clean, drained and dry before it is allowed into another water body. Therefore, if a boat has small amounts of standing water (must be less than **five** gallons) and the boat has **not** been in positive or suspect waters, you must still get the water out of the boat. The inspector should have a small pump and sponges/towels available at the inspection station to assist with the draining of boats. If using these tools does not ensure a fully drained vessel (ballast tank, gravity emptied live wells with long discharge hoses, etc.) then the interior compartments with water remaining must be flushed with 120°F water.

**Be extremely cautious with OUT OF STATE BOATS because most other states do not have extensive sampling programs focused on early detection. We do not know which lakes are or are not infested in those states.**

Interior compartments that may hold water, including, but not limited to live/bait wells, ballast, anchor compartments, bilge areas and their corresponding intake ports, must be flushed with 120°F water at **low pressure**. This can be accomplished by removing the nozzle from the end of the wand or using a diffuser attachment.

Due to our research findings about ballast, bilge, or live/bait well pumps it is important to adjust the temperature of the decontamination unit to 120°F to ensure that no damage is done to the pump during the decontamination process. Please keep in mind that the veligers will die at temperatures that exceed 95°F.

***Note:** Prior to decontaminating interior compartments with pumps, be sure that you have tested the temperature of the water to ensure that your unit is operating at 120°F and verify using a digital thermometer that the water reaches 120°F exiting the boat. Engines and motors are flushed using 140°F low pressure hot water.*

## Pump Temperature Rating Table

Manufacturer	Temperature Rating
Atwood Corporation	130°F
Johnson Pumps of America	170°F
SHURflo Pumps	140°F
ITT Manufacturers	120°F

## What are pump temperature ratings?

Pump manufacturers were consulted during the drafting of this manual. In rare occasions, marine/transfer pumps could be damaged by the use of hot water temperatures during the decontamination process. More research is needed in this arena. The following is a list of some popular manufacturers, pump types and their recommended temperature ratings. Due to the complexity of pumps and the various brands and ratings, it is required that interior compartments are decontaminated at 120°F with low pressure.

**Attwood Corporation.** Makers of bilge pumps. Models include: Sahara, Heavy Duty, and Tsunami. They also carry the Tsunami Aerator for live wells. Pumps are rated at 130°F. However, they can withstand 140°F for approximately five minutes before damage may occur.



**Johnson Pumps of America.** All of their pumps are rated for 170°F.





**SHURflo Pumps.** All of their current pumps will tolerate 140°F. However, they will incur damage at temperatures of 145°F and above due to the ABS plastic that they use.



**ITT manufacturers.** They make Rule pumps. Their pumps are rated for 120°F. Extended exposure at hotter temperatures will cause damage.



*Note: Rule pumps cannot be exposed to bleach.*

### Examples of live well and aerator pump diagrams

Below are some examples of live/bait wells from the Lund Boat Company. This section is intended to provide decontaminators additional information regarding the complexities of wells.

Only low pressure and 120°F water can be used when decontaminating a live/bait well to ensure no damage is done to any of the numerous parts.

The **ProLong Plus** is designed with a freshwater pickup integrated into the bottom of the hull where it forces a steady flow of water into the live well while the boat is running.

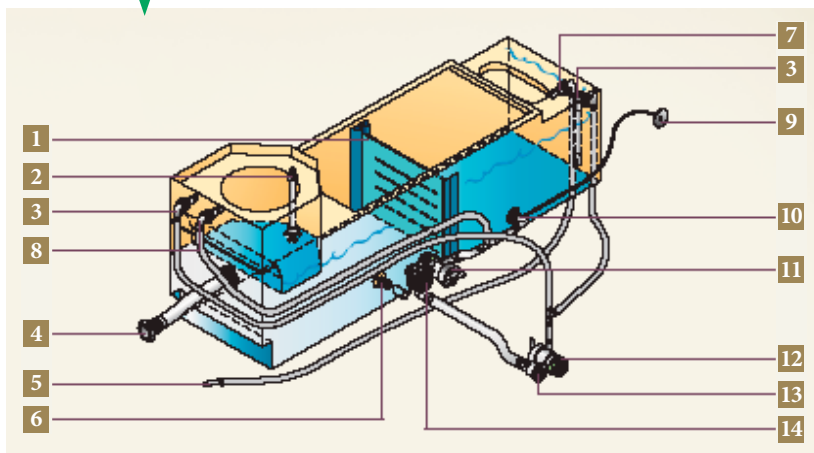

DIAGRAMS © LUND BOAT COMPANY AND CRESTLINER BOAT COMPANY

This a **two-pump design**. One pump fills and aerates the well from above the fish while the other recirculates and injects fresh air via the Max-Air system for the oxygenation.

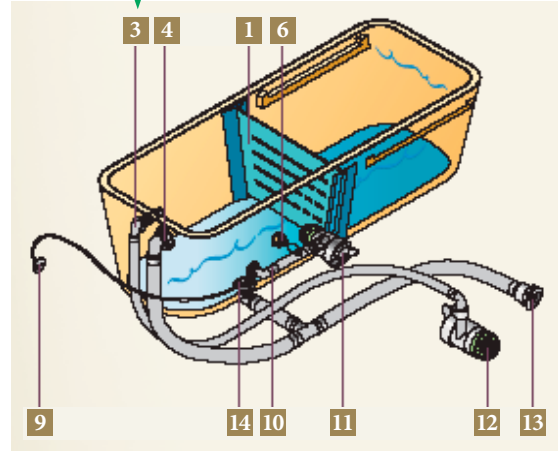

This live well features a **single pump** with a single-switch control. The aerator pump can be run continuously in manual mode or intermittently in automatic mode when equipped with a timer.

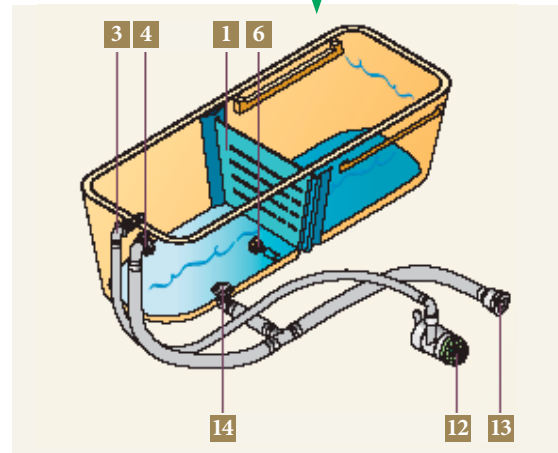

The numbers on the following list refer to individual parts shown in all three diagrams.

- 1—Removable divider
- 2—Baitwell drain
- 3—Fill spray head
- 4—Overflow
- 5—Freshwater pickup
- 6—Waterproof light
- 7—Freshwater pickup spray head
- 8—Recirculating spray head
- 9—Max-Air intake
- 10—Recirculating outlet
- 11—Recirculating pump with filtration screen
- 12—Aerator pump with filtration screen
- 13—Through-hull drain
- 14—Drain with plug





# Step-by-Step Procedure for Standing Water Decontaminations

## Standing Water Decontamination of Interior Compartments

1—Follow the standard operating procedures for your decontamination unit (See pages 5–9).

- Check all fluid levels of the decontamination unit. With the trigger squeezed, start the unit and purge the water until it runs clear.

2—Turn on the burner, and measure the temperature of the water. 

3—Start the decontamination by placing the tip of the wand (nozzle removed) or the diffuser on the through hull discharge port(s) and flush this for one minute. Diffuser attachment shown. 

4—Turn off the decontamination unit by turning the burner off first and then turn off the key so that the unit does not stay in the bypass mode too long while you are climbing into the boat to flush the interior compartments.

5—Next, have the boat operator open all interior compartments that need to be decontaminated and remove plugs. Restart the decontamination unit and flush the compartment. Use a laser thermometer and measure the temperature at the through hull discharge port for that compartment. Continue flushing until the exit temperature of the water is 120°F. Be sure to keep the tip of the attachment close to the sides of the compartment to prevent temperature loss. Start at the bow of the boat and work your way to the stern. 

6—If equipped, have the boater turn on the discharge pump for the compartment. 

7—Turn off the decontamination unit when you have completed decontaminating all necessary interior compartments. Turn the burner off first, run some water through the boiler and then turn off the key. Follow the standard operating procedures for shutting down your decontamination unit.

8—On the *Watercraft Inspection And Decontamination Activity Log*, be sure to mark “Standing Water Decontamination” under the “Results” section.

9—If exiting, apply a green seal and give the boater a properly filled out receipt. Remind the boater to dry.



## Step-by-Step Procedure for Standing Water Decontaminations (cont.)

### Standing Water Decontamination of Outboard Motors and Inboard/Outboard Engines



Outboard Motor



Inboard/Outboard Engine

All decontamination stations should have at least two models of decontamination muffs; a type for the newer Mercury engines that threads through the intake ports that are completely open; and another clamp style muff for all other engines. ➔



The following photos show the use of the threaded Mercury muffs. ➔

1—Attach the hose to the end of the wand (quick connect fitting). ➔



2—Then attach the muff attachment to the hose. ➔





3—Make sure the motor/engine is completely lowered. Place the muffers so that all the intake openings are completely covered. When threading the Mercury muffers, place the wire through the center opening to ensure all openings are covered.



4—Start the decontamination unit following the standard operating procedures.

5—Start the water by engaging the trigger. Check to make sure the intake openings are still covered on both sides and that the muffers are tight.

6—Stand clear of the propeller and have the boat operator start the motor/engine in **Neutral**.



7—Flush the engine until the water temperature is 140°F when measured by a laser thermometer at the discharge port(s).



8—Have the boat operator turn off the motor/engine.

9—Turn off the decontamination unit by turning the burner off first, run some water through the boiler and then turn off the key. Follow standard operating procedures for shutting down your decontamination unit (See pages 6 and 9).

10—Remove the muffers and allow the motor/engine to drain; have boat operator raise and lower the motor/engine twice.

11—The gimbal area of the inboard/outboard engine must be decontaminated for a minimum of 45 seconds with 140°F water under low pressure to ensure adequate exposure time.

12—On the *Watercraft Inspection And Decontamination Activity Log*, be sure to mark “Standing Water Decontamination” under the “Results” section.

13—If exiting, apply a green seal and give the boater a properly filled out receipt. Reminder the boater to dry.



## Step-by-Step Procedure for Standing Water Decontaminations (cont.)

### Standing Water Decontamination of Inboard Engines and their Bilges

*Note: Most inboards, but not all, that have the engine in the center of the boat do not have ballast tanks.*

All inboard intakes, which are located on the bottom of the hull directly under the engine, have a cover over the opening that protects the engine from sucking up large particulates. Some inboards have a hose attachment in the engine compartment for decontamination. However, this boat still needs to have hot water flushed between the intake hull fitting and the hose that connects to the engine for thorough decontamination. ➤



1—Attach the hose to the end of the wand (quick connect fitting) and then attach the fake-a-lake attachment. ➤



2—The fake-a-lake must be placed snugly against the bottom of the hull covering the intake port for the inboard. ➤



3—Start the decontamination unit following the standard operating procedures.

4—Start the water by engaging the trigger.

5—Stand clear of the propeller and have the boat operator start the engine in Neutral.

6—Flush the engine with low pressure water until the exit temperature of the water is 140°F when measured with a laser thermometer at the discharge port(s).

7—Have the boat operator turn off the engine.

8—Turn off the decontamination unit by turning the burner off first and then turn off the key.

9—Remove the fake-a-lake from under the boat; disconnect the hose from the wand.

10—Flush the bilge with 120°F low pressure water.

a. Make sure that the bilge plug, located in the center access area, is **in**.

b. Add 4–5 gallons of water into the bilge by putting the wand (nozzle removed) down behind the engine next to the floor. 

c. Then **remove** the bilge plug and continue to flush until the exiting water reaches 120°F. 



11—Turn off the decontamination unit by turning the burner off first, run some water through the boiler and then turn off the key, and have the boat operator run the pump to assist in water removal. Follow the standard operating procedures for your decontamination unit.

12—On the *Watercraft Inspection And Decontamination Activity Log*, be sure to mark “Standing Water Decontamination” under the “Results” section.

13—If exiting, apply a green seal and give the boater a properly filled out receipt. Remind the boater to dry.



## Step-by-Step Procedure for Standing Water Decontaminations (cont.)

### Standing Water Decontamination of Ballast Tanks

*Note: Most inboards, but not all, that have the engine in the center of the boat do not have ballast tanks.*

1—Follow the standard operating procedures for your decontamination unit (See pages 5–9).

- Check all fluid levels of the decontamination unit. With the trigger squeezed, start the unit and purge the water until it runs clear.

2—Turn on the burner, and measure the temperature of the water.



3—Once the water temperature reaches 120°F, start the decontamination by placing the tip of the wand or the diffuser on the through hull discharge port(s) and flush this for **one** minute.

4—Turn off the decontamination unit by turning the burner off first and then turn off the key so that the unit does not stay in the bypass mode too long while you are changing the attachments.



5—Attach the hose to the end of the wand (quick connect fitting) and then attach the fake-a-lake attachment.





6—The fake-a-lake must be placed snugly against the bottom of the hull covering the intake port for the ballast tank.



7—Start the decontamination unit and then start the water by engaging the trigger.

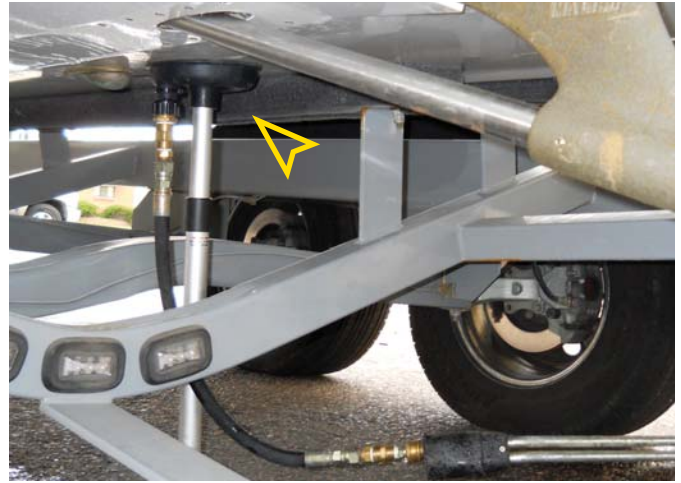

8—Have the boat operator turn on the intake ballast pump. Fill it up with low pressure or until the exit water temperature reaches 120°F. If there is no ballast tank discharge pump, flush the ballast tanks with 120°F water for at least 3–5 minutes.



*If you have a “mussel boat” and are doing a full decontamination, fill up each ballast tank and drain it twice with hot water at 120°F.*

*All other scenarios, ballast tanks will be flushed until the decontamination water temperature exiting the watercraft is 120°F.*



9—Have the boat operator turn off the intake ballast pump. Release the trigger to stop the water flow.

10—Turn off the decontamination unit by turning the burner off first, run some water through the boiler and then turn off the key so that the unit does not stay in the bypass mode too long while you are changing the location of the fake-a-lake.

11—Have the boat operator turn on the ballast tank discharge pump to drain the tank as much as possible.

12—Repeat these steps for every ballast tank.

13—On the *Watercraft Inspection And Decontamination Activity Log*, be sure to mark “Standing Water Decontamination” under the “Results” section.

14—If exiting, apply a green seal and give the boater a properly filled out receipt. Remind the boater to dry.



**State of Colorado**  
**INSPECTION AND DECONTAMINATION SEAL RECEIPT**  
For use when applying green seals to boats.  
Provide original to watercraft owner (white) and keep carbon copy (yellow).

Location: McPhee  
Date/Time: 6/19/11 10:30 AM  
Inspector's ID #: 1147  
Vessel Registration (CL #: CL 2876 LU  
Seal Serial #: 6325173

**SEAL AND INSPECTION TYPE**

Clean, Drain, Dry Inspection:	<input type="checkbox"/> Performed	or	<input checked="" type="checkbox"/> Not Performed
High Risk Inspection:	<input checked="" type="checkbox"/> Performed	or	<input type="checkbox"/> Not Performed (High Risk Inspection minimum at containment reservoirs)
Full Decontamination:	<input type="checkbox"/> Performed	or	<input checked="" type="checkbox"/> Not Performed
Standing Water Decontamination:	<input checked="" type="checkbox"/> Performed	or	<input type="checkbox"/> Not Performed
Plant Decontamination:	<input type="checkbox"/> Performed	or	<input checked="" type="checkbox"/> Not Performed
Bait Treatment:	<input type="checkbox"/> Performed	or	<input checked="" type="checkbox"/> Not Performed

**HOW TO TREAT A BOAT WITH GREEN SEALS**

Cut off seal and let boat launch if:

- 1.) Boat is returning to the same location; or
- 2.) Boat has been out of the water for more than 30 days; or
- 3.) Boat is clean and fully drained.

If not, perform an inspection prior to launch.

THANKS—Please save this receipt and dry your boat.

Distribution: White—Owner/Operator Yellow—Inspection Location

2/2011 - 86100 11-309932/278711

# What is the protocol for plant decontamination?

True aquatic plants are defined as plants that are normally completely or mostly submerged in water and are unable to survive for long periods outside of water. Submerged aquatic weeds are commonly transported via watercraft, usually by getting tangled around motors, engines, and anchors. Most aquatic weeds can establish new populations with only a tiny fragment of the parent plant. Those tiny fragments can be carried overland on watercraft, trailers, anchors, fishing equipment, water ski equipment, etc. It is the inspectors and the boaters responsibility to ensure plants are not transported on boats.

During the entrance and exit inspection, any plant or plant fragment must be hand removed and properly disposed of away from the lake or reservoir by the inspector or boat operator. However, there may be a situation when plant material is caught between the hull of the vessel and the trailer bunk or roller, or is wrapped around the propeller or transducer, and can't be completely removed by hand.

It then becomes mandatory for the boat inspector to decontaminate those areas of the vessel where the plant fragments remain. **Remember**—heat kills.

## Step-by-Step Procedure for Plant Decontamination

- 1—Start the decontamination unit using the standard operating procedures for your unit (See pages 5–9).
- 2—Apply low pressure 140°F water directly to the plants or plant fragments for 15 seconds.
- 3—Decontaminate areas where plants are located and can't be removed:

*If plant material is found on a boat with ballast tanks, the tanks must be flushed to eliminate possible fragments within.*

- a. **Trailer's carpeted bunk.** Use 140°F water at low pressure. Move the wand/diffuser **slowly** along the length of the bunk. Keep the tip of the wand/diffuser close to the bunk to maintain an even temperature.
- b. **Trailer's frame, and rollers.** Use 140°F water at high pressure. Move the wand/diffuser **slowly** along the length of the trailer. Keep the tip of the wand/diffuser close to the trailer to maintain an even temperature.



PHOTO © MICHIGAN SEA GRANT





c. **Propeller.** Use 140°F water at high pressure. Be thorough and remove 100% of the plant material. In order to avoid too much spray when decontaminating the propeller, the boat decontaminator can turn the wand handle one quarter turn away from him/herself to lower the pressure.



d. **Transducer.** Use 140°F water at low pressure. The wiring and “water wheel” attached to this instrument dictate that low pressure is used in order to prevent damage.



e. **Interior compartments.** Follow standing water decontamination protocol (See pages 13–19).

4—Turn off the decontamination unit by first turning off the burner, engage the trigger to run water through the burner to cool it, and then turn off the key. Follow the standard operating procedures.

5—Put a check under the “Results” heading under “Plant Decontamination” on your *Watercraft Inspection And Decontamination Activity Log* (See page 43).

6—If exiting, apply a green seal and give the boater a properly filled out green seal receipt. Remind boater to dry.

*Note: If a boat from a reservoir/lake that is not known to be positive for that plant species (Eurasian watermilfoil for example) comes to your station and has plant material that you believe is an ANS (Check the ANS Watercraft Inspection Handbook or your ANS Pocket Guide), please take a sample following the protocol on the page 4 (ANS) Documentation and Vessel Decontamination Form. Send plant samples to:*

*Invasive Species Coordinator  
Colorado Division of Wildlife  
6060 Broadway  
Denver, CO 80216*

*Let them know that the sample is coming by emailing [ReportANS@state.co.us](mailto:ReportANS@state.co.us). Notify the Invasive Species Coordinator by calling (303) 547-8690 and forward the sample photos.*

However, if the plant material is an ANS plant species from a known infestation (See list on page 22), do **not** take a sample. Remove all plant material and put it in the trash. If a complete removal is not possible, decontaminate the sections of the watercraft that are affected.







The following is a list of the positive recreational waters with Eurasian watermilfoil in Colorado:

- Arvada Reservoir—Arvada, CO
- Big Dry Creek—Westminster, CO
- Boulder Creek—Boulder, CO
- Bow Mar Lake—Denver, CO
- Brush Hollow Reservoir—Penrose, CO
- Douglas Reservoir at Douglas State Wildlife Area—Ft. Collins, CO
- Eleven Mile Reservoir at Eleven Mile State Park—Lake George, CO
- Horseshoe Lake and Martin Lake at Lathrop State Park—Walsenburg, CO
- Marston Reservoir—Denver, CO
- Prospect Lake—Colorado Springs, CO
- Rio Grande River—Alamosa, CO
- Sheets Lake—Westminster, CO
- South Platte River—from St. Vrain Creek into Weld County
- St. Vrain Creek—from confluence of Boulder Creek into the South Platte River
- Mallard Ponds at St. Vrain State Park—Longmont, CO
- Standley Lake—Westminster, CO
- Tucker Lake—Arvada, CO
- Ward Road Ponds—Wheat Ridge, CO
- West Lake—Wheat Ridge, CO

The following is a list of the positive waters for the invasive hybrid Eurasian watermilfoil (shown above) and the native Northern watermilfoil (*Myriophyllum spicatum* x *Myriophyllum sibiricum*) in Colorado:

- Cherry Creek Reservoir at Cherry Creek State Park—Aurora, CO
- Cigar Pond at Chatfield State Park—Littleton, CO

## What do the regulations say about live aquatic bait?

Colorado Division of Wildlife and Colorado State Parks regulations require that **all live aquatic bait must be purchased from an authorized Colorado bait dealer** and must be accompanied by a **dated receipt**. The receipt is valid for ANS inspections for **seven days**.



- Live fish are only allowed for use as bait on the East Slope below 7,000 feet and at Navajo Reservoir.
  - In those areas, the transportation of live fish as bait is prohibited between waters unless it was purchased from a Colorado bait dealer, as described above.
  - Fish harvested in the wild for use as live bait can only be used in the water in which it was caught and can no longer be transported and stored for later use.
    - The exception is fish harvested within Bent, Crowley, Kiowa, Otero, or Prowers counties which can be transported and used only within those five counties.
- The transportation of live crayfish is prohibited on the west slope and from Sanchez Reservoir.
- It is unlawful to transport live bait across state lines without an import permit.



© PHIL MYERS, MUSEUM OF ZOOLOGY, UNIVERSITY OF MICHIGAN



© JOHN WOODLING

# What is the protocol for live aquatic bait treatment?

If a vessel has live aquatic bait in a container or a well with standing water, be sure to check the *Watercraft Inspection And Decontamination Activity Log* box under “Live Bait” in the “Determine Risk Factors” section. Then ask the boater for a bait receipt. (**Remember**—under Colorado Fishing Regulations only live fish bait mandates a receipt that lists the name of the bait and the number. Other live aquatic bait, i.e. crayfish, salamanders, etc. will only have a basic store receipt without that information.)

In places where live bait is allowed, the inspection or treatment will vary depending on the location and type of bait.

If the boater has bait in a container or in a well with standing water, allow the boater to proceed and launch with the bait as is if:

- The receipt is from a Colorado bait dealer **and**
- The receipt is dated no more than seven days **and**
- The species listed on the receipt matches up with the bait in question.

**If the receipt is older than seven days**, perform a bait treatment to remove the threat of ANS in the bait-water. Ask the boater to **remove** the bait from the vessels live well or container and **place it into a holding container**. The live well or container must be drained and decontaminated using standard decontamination procedures (120°F water rinse with low pressure) before the bait is returned. If entering, the container or well water will be replaced with water from the lake or reservoir the boat is launching in.

**If the boater DOES NOT have a receipt** the live aquatic bait will not be permitted for use and will have to be properly disposed of in the trash. However, the following scenarios will result in a bait treatment being performed and the bait will be permitted for use following treatment:

- If the bait is fish and was harvested within ½ mile of the reservoir from man-made ditches or canals.
- If the bait is fish and was harvested within the five county exemption described on page 22.
- If the bait is wild harvested non-fish bait (crayfish, frogs, salamanders).



## Out of state bait is not permitted for use.

When the boater leaves your waters, encourage him/her to properly dispose of bait in the trash, never in the water. Completely drain the live/bait well and any other containers. You may need to sponge or hand pump the water from the live/bait well out so that no water leaves your site.

**Note:** Any live aquatic bait purchased from an out-of-state dealer is illegal and must be disposed of in the trash. **Do not allow it to be used at your water body.**



## Step-by-Step Procedure for Bait Treatment

As much as possible, **minimize transferring water to the holding container**. The live/bait well or container must be drained and decontaminated using 120°F low pressure water before the bait is restocked in the container that has been re-filled with water from the lake the boat will be entering. If a decontamination unit is unavailable or not working properly, completely dry out the original container using a paper towel or cloth. If exiting, do not allow water from any reservoir, especially a containment reservoir, to leave in a bait bucket or live well.

**1**—Using a net, transfer the bait to a holding container filled with reservoir water. Minimize the transfer of water from the original container as much as possible.





2—Drain the original container or compartment (e.g. live well). 



3—Follow standard operating procedures for your decontamination unit (See pages 5–9).

- Check all fluid levels of the decontamination unit. With the trigger squeezed, start the unit and purge the water until it runs clear. Turn on the burner, and measure the temperature of the water.

4—Flush the live/bait well, compartment or container with low pressure until the exit temperature of the water reaches 120°F. Be sure to keep the tip of the attachment close to the sides of the compartment to prevent temperature loss. If using the wand, be sure to **remove the nozzle** so that you are using low pressure. 

- If there is a discharge pump for the live/bait well, you can use a laser thermometer and measure the temperature exiting the through hull discharge port for that compartment.



5—Follow standard operating procedures for shutting down your decontamination unit.

- Turn off the decontamination unit; turn the burner off first, run some water through the boiler and then turn off the key.

6—Whenever possible, water from the reservoir the boat is entering should be used for restocking the bait. Do not use tap water, as chlorinated water can kill live aquatic bait. 



7—If exiting, the container or well water will be replaced with water from a sealed container or non-chlorinated source. Do not allow water from any reservoir, especially a containment reservoir, to leave in a bait bucket or live well.

# Full Decontamination for Suspect or Confirmed Mussels or other ANS

If you suspect that you have found mussels or another ANS, or you know you have a mussel boat, the following are the steps that you must perform in order to comply with Colorado State protocol. If only one single adult mussel shell is found, you must do a full decontamination. Any evidence or suspicion of adult or juvenile mussels requires a full decontamination.



Remember it is required that you **report, document, collect, and decontaminate**. Follow these documentation and reporting procedures and do not allow the boater to leave with mussels or other ANS attached to the boat.

If a watercraft is highly encrusted with zebra or quagga mussels, it can be quite difficult to effectively remove all the mussels from the watercraft. It can take several days for the dead mussels' byssal threads to detach and for gravity to pull them out of the watercraft. Always try to remove all mussels from the watercraft prior to releasing it. If a boat is too highly infested to fully remove mussels at the inspection station, make arrangements for the boat to be serviced at a certified marina or marine business prior to releasing it. If the boat owner is not cooperative, you will need the assistance of law enforcement to quarantine the vessel or escort it to a certified marina or marine business to ensure all mussels are dead and removed.

## Report

Use one of the following three options to report your suspected ANS discovery immediately:

1—**Telephone.** (303) 291-7362 or (303) 547-8690

2—**Email.** [ReportANS@state.co.us](mailto:ReportANS@state.co.us)

3—**Website.** [www.colorado.gov/wildlife](http://www.colorado.gov/wildlife)

Your initial report can be brief but should include the following essential information:

- Date/Time
- Location—**both** the boat's current location and the boat's history (i.e. waters visited in the last 30 days)
- Home state of the boat
- Location where the boat became infested, if known
- Suspected species of ANS
- Name of Reporter (Inspector)



## Document

1—Once mussels are found (or suspect mussels or other ANS), a full decontamination is required. You must first conduct a **high risk inspection** on the vessel to identify all areas that are infested on the vessel. You must fill out the *High Risk (ANS) Inspection Form*. Be as accurate as you can and inspect and complete every item on the form that applies to the boat.

2—Take **digital photos** of the entire boat before, during (if possible), and after the decontamination. Always have extra batteries ready for the camera, set the date on the camera, and practice taking close up photos.

- Start taking photos at the CL number and work your way around the boat to end at the same CL number. Note any damage or ANS on the boat. If available, take a video of the boat while you walk around it. Both video and photos are desired. Photograph an overview of the entire boat, the registration number, the rear of the boat (to verify the name of the boat), and note any areas where existing damage occurs on the boat, and the area(s) of the boat where the specimen is detected. End with a photo of the CL number. The standard number of photos is 10, but there is no maximum.
- For boats with gimbals (inboard, inboard/outboard, stern drives, etc.) get good photos of gimbal boots from several angles to document before and after condition.
- Take **digital photos** of the ANS specimen. Take both far away and close up photos of the specimen on the boat. Take photos of where the specimens are located on the boat. There may be numerous places, so be sure to photograph each location. Change your camera setting to close up mode (icon is a flower) and then take close up photos. If specimen is a zebra or quagga mussel try to get a good close up photo of the byssal threads. Next, place a common object such as a pencil or penny next to the specimen and photograph the combination to demonstrate the relative size of the specimen.

- **You must photograph the vessel after decontamination** in the same fashion and same locations as you photographed the boat before the decontamination.

3—Fill out the first two pages of the (ANS) *Documentation and Vessel Decontamination Form*.

- Start at the top right by filling in the water code, date, and boat CL#.
- Under “Reason for Decontamination,” be sure to check all that apply in the following list:
  - Possible Mussels (bumps that look like mussels)
  - Zebra/Quagga Mussels Visible
  - Other (for suspected ANS).

Use page 2 of the (ANS) *Documentation and Vessel Decontamination Form* to document your findings: who, when, where, and how it was found, etc. Be sure to document any existing damage on the boat in the area provided.

Be sure to document specifically where the boater is coming from, where it became infested and any waters it was in since infestation. If it is not known where it became infested, document all waters the boat visited in the last 30+ days. Record as much information about the boat’s history as possible.

Email the photos and description to [ReportANS@state.co.us](mailto:ReportANS@state.co.us) and call the Invasive Species Coordinator within 24 hours at (303) 547-8690.

4—Use page 3 of the (ANS) *Documentation and Vessel Decontamination Form* to document the placement of the ANS on the vessel. Again, be as accurate as possible when filling out this form.

## Collect

After photographing the vessel, collect several **samples** of the mussels or suspect ANS and fill out page 4 of the (ANS) *Documentation and Vessel Decontamination Form*. Make sure your focus on the many close up digital photos is clear before the samples are detached from the boat. If possible, take photos of the collection being done. Be sure to properly preserve the samples following the instructions on the top of page 4 of the *Decontamination Form* (page 41), utilizing supplies from the DOW-provided sampling kit. After the sample is removed, take photos of the infested area. All samples and the white copy of page 4 must be sent to the Aquatic Animal Health Lab (AAHL) within 24 hours.

1—Only fill 50% of the vial with 70% ethanol or grain alcohol, **not rubbing alcohol**. (This can be purchased directly or can be made up from 100% grain alcohol such as 190 Proof Everclear® diluted with **deionized** or **distilled** water. Even trace amounts of chlorine from tap water, or

“de-chlorinated” tap water can completely destroy sample DNA.) Remove as many specimens as will fit in the specimen vial without the vial overflowing. It is acceptable to send more than one vial.

2—Tightly seal the vial. Write the date/location/contact information on the vial’s label with a pencil. If there are numerous areas of attachment on the boat, take samples from those numerous areas as well.

3—Place the vials in a Ziploc® bag and wrap in bubble wrap to help protect it during shipment.

4—Complete the lower half of page 4, the *Suspected ANS Collection Form For Watercraft Inspection Stations* and place in the padded envelop with the sample(s).

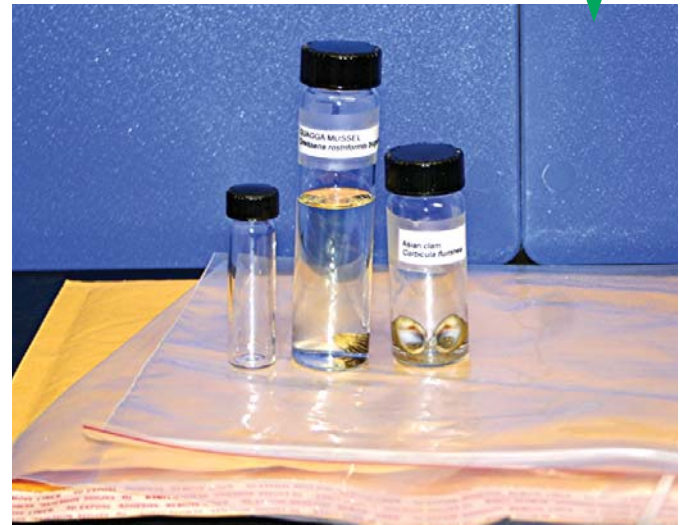

5—FedEx the envelope ASAP (within 24 hours) to:

Colorado Division of Wildlife  
Aquatic Animal Health Lab  
122 E. Edison St.  
Brush, CO 80723

6—Email [ReportANS@state.co.us](mailto:ReportANS@state.co.us) to notify DOW that the sample is being shipped.

## Decontaminate

For a full decontamination, all parts of the vessel must be exposed to hot water at the appropriate temperature and pressure to ensure the ANS are dead and removed.

Almost all sites have a hot water high pressure decontamination system to decontaminate the boat and trailer. If you do not, and you know you have a mussel boat, call for help and do not allow that boat to leave without decontamination. If needed, get a qualified peace officer (Wildlife Manager, Park Ranger, Sheriff, etc.) to escort the watercraft to a nearby decontamination unit or quarantine the vessel until a decontamination unit can be brought to you.



- 1—Flush all discharge ports with 120°F water at low pressure for **one** minute.
- 2—Bilge area and pump, live/bait wells and pumps, ballast tanks and pumps, and other interior compartments with pumps must be flushed with 120°F water at low pressure.
- 3—All carpets, gear, and other equipment should be saturated with 120°F water under low pressure.
- 4—The motor/engine must be flushed with 140°F water at appropriate pressure.
- 5—The trailer must be sprayed and pads soaked with 140°F water at low pressure.
- 6—The hull must be sprayed with 140°F water at high pressure.

**Only state-certified authorized agents should operate decontamination units.** Public and staff safety should always be top priority. Never allow a member of the public or a non-certified employee to decontaminate a boat. Be sure to document all procedures used to decontaminate the boat. Photograph or take video of the decontamination being performed if more than one inspector is present.

It is recommended that you decontaminate in the following order:

- a. Flush the **through hull discharge ports**.
- b. Flush the **interior compartments on the boat**.
- c. Flush the **motor/engine**.
- d. **Rinse the exterior of the boat and trailer** with 140°F water to kill the mussels or ANS.
- e. **High pressure spray the hull** or infected areas to remove the mussels or ANS.

## Step-by-Step Procedure for Full Decontamination

- 1—Follow the standard operating procedures for your decontamination unit. Check all fluids on the decontamination unit to make sure it is ready to run.
- 2—Connect the wand to the trigger to the hose. Start the decontamination unit using the proper operating procedures for your unit.
- 3—Check the temperature of the water and adjust the temperature depending on the procedure being performed at that time.

- 4—Before beginning decontamination, climb into the boat. Work with the boater to prepare the interior compartments that will be decontaminated. With help from the boat operator, identify the discharge ports for the interior compartments. 



- 5—**Decontaminate the through hull discharge ports.** Press the wand (no nozzle attached) or diffuser up against the opening of the through hull discharge ports and decontaminate each port with 120°F water under low pressure for one minute. Turn off the decontamination unit. (Turn the burner off first and then turn off the key.) 



## 6—Decontaminate the interior compartments.

Reposition the hose and wand to the forward interior compartments. Start the decontamination unit and work from the front to the back of the boat using low pressure 120°F water to decontaminate every compartment that has standing water or has equipment that has come into contact with the water body.

- If the boat has an inboard/outboard or inboard engine have the boater raise the lid of the engine compartment and put the wand behind the engine to decontaminate the floor of this area.
- Turn off the decontamination unit. After all interior compartments have been decontaminated have the boat operator activate the pumps to drain the interior compartments as much as possible.



## 7—Decontaminate the motor/engine. Turn the temperature of the unit to 140°F.

### • Procedure for outboard motors and inboard/outboard engines (page 14).

- Have the boat operator lower the motor/engine to a vertical position. Attach the hose to the end of the wand using the quick connect fitting.
- Attach the muffs to the hose and place over the intake holes on the lower end of the motor/engine.
- Start the decontamination unit and start the water flowing through the muffs. Check to make sure the intake holes are completely covered. Have the boater start the motor/engine in **Neutral**. Run until the existing water reaches 140°F. Turn off the decontamination unit.
- The gimbal area of the inboard/outboard engine must be decontaminated for a minimum of 45 seconds with 140°F water under low pressure to ensure adequate exposure time.



- **Procedure for inboard engines (See pages 16–17).**

- Find the engine inlet: This intake always has a screen cover and is located directly under the engine on the hull. 



- Attach the fake-a-lake to the hose. Adjust the fake-a-lake so that it covers the engine intake port. 



- Start the decontamination unit and start the water flowing. Have the boater start the engine in **Neutral**. Run until the exiting water reaches 140°F. Turn off the decontamination unit.

- Flush the bilge with 120°F low pressure water.

- a. Make sure that the bilge plug, located in the center access area, is **in**.



- b. Add 4–5 gallons of water into the bilge by putting the wand (nozzle removed) down behind the engine next to the floor. 



- c. Then **remove** the bilge plug and continue to flush until the exiting water reaches 120°F. 





- On an inboard engine, the strut bearing and the rudder port must be decontaminated.
  - a. Flush the strut bearing with low pressure; use high pressure if attached mussels are found. 
  - b. Flush the rudder port. 



**8—Decontaminate the exterior of the hull and trailer.** Remove the muffs/fake-a-lake and hose from the wand. Connect the 40° nozzle with the use of the quick connect to the end of the wand. Reposition the hose and wand to the front of the boat farthest from the decontamination unit. Start the decontamination unit. Keep the wand at a 45° angle and work methodically in one direction. Do not use the wand to “scrub” the hull. Keep the tip of the wand within a few inches of the hull and trailer as 



you move around the boat. Water temperature decreases approximately 15 to 20° per foot of distance when sprayed from a power nozzle. 

**WARNING:** Use low pressure on all carpeted areas, decals, electrical connections, gimbal area on the inboard/outboard engine, interior compartments, transducers, and depth sounders and their wiring.



On trailers, be sure to decontaminate the openings of the tubular frames.



Turn off the decontamination unit. Turn the burner off first, run some water through the boiler and then turn off the key. Follow the standard operating procedures for your unit.

9—Following full decontamination, give the boat some time to fully **drain the water**. In most cases of badly infested vessels, dead mussel shells will be released from the vessel and will drain out in the water following decontamination.

- If mussel shells are still coming out of the areas draining or can be seen in interior compartments, you will need to **re-flush** those areas to get the mussels out of the vessel.

10—Conduct a **final high risk inspection** of the vessel using the *High Risk (ANS) Inspection Form*. Be sure to check all areas that were previously noted as infested prior to inspection. Also check all other areas of the boat to be sure that there are no mussels (dead or alive) remaining on the vessel. Be as accurate as possible when checking the numerous areas of the boat. If staff allows, it is preferable that the second high risk inspection following decontamination is done by someone other than the person who did the initial inspection and decontamination.

- a. If there's any evidence that mussels or other ANS remain—begin decontamination again!
- b. If it's a highly encrusted watercraft you may consider quarantining the vessel for a few days to allow the byssal threads to release and the mussels to be removed by subsequent decontaminations. You may also want to consider sending the boat with an escort to a certified marine business for servicing. If the boater is not cooperative with these options and you feel they are necessary, you may require the assistance of a qualified peace officer to order the quarantine or escort the watercraft to the dealer.

11—Be sure to **provide the boater the pink copies** of the two *High Risk Inspection Forms* and four-page *Decontamination Form* and the white copy of the seal receipt. The **inspection station keeps the yellow copies** of all these documents.



12—**Within 24 hours**—email the photos of the ANS specimens to [ReportANS@state.co.us](mailto:ReportANS@state.co.us). If you have the ability to scan the forms please email them also. Mail in the **white copies** of the two *High Risk (ANS) Inspection forms* and pages 1–3 of the *(ANS) Documentation and Vessel Decontamination Forms* to:

Colorado Division of Wildlife  
Attn: Invasive Species Coordinator  
6060 Broadway  
Denver, CO 80216

13—**Apply a green seal** and give the boat operator the white copy of the seal receipt. Be sure to fill out all procedures that were and were not performed on the seal receipt.

- If this was a highly encrusted mussel boat, write “MB” in the upper right corner of the receipt.
- Remind the boater to fully dry.

14—Be sure to mark “Full Decontamination” under the “Results” section on the *Watercraft Inspection And Decontamination Activity Log*, and enter the seal code of the green seal applied.

15—If known, notify the lake or reservoir inspection station where the boater plans to launch next.

# Step-by-Step Procedure for Malibu Wakeboard Boats

Tommy's Slalom Shop specializes in Malibu Wakeboard boats and recommends the following procedure for inspection and decontamination. Malibu boats only use SHURflo Piranha 800 pumps which are rated to 165°F. These pumps have been temperature rated and are able to be flushed at 140°F.

*Note: Most inboards, but not all, that have the engine in the center of the boat do not have ballast tanks.*

**WARNING: Some wakeboard boats, particularly those older than 2006, may have ballast tank pumps which are only rated for 130°F water. Take caution with these older boats and decontaminate interior compartments with 120°F water.**

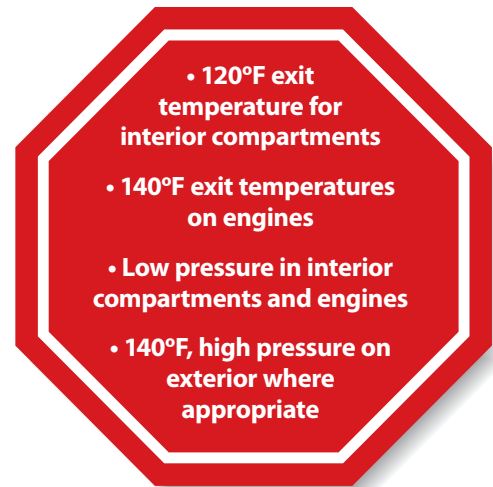



## Inspection

1—Visually inspect the outside of the vessel including the hull, trailer, and all intake and discharge ports. Be sure to feel and look into all ports.

2—Inspect prop shaft and rudder port.

3—Inspect the bilge inside the boat.

- a. Open engine compartment—inspect floor. This area usually has two pumps; these are the fill pumps for the two rear ballast tanks. 
- b. Open the center access hatch—usually located under the carpeting. This area has the plug for the bilge. It also has three pumps: One is the **fill** pump for the front ballast tank, the second is the **fill** pump for the center ballast tank and the third is the **discharge** pump for the center ballast tank. 

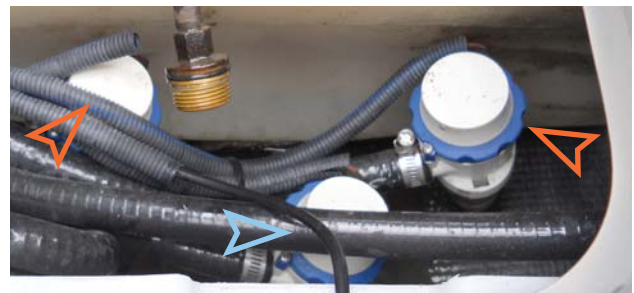

4—Inspect all interior compartments that store equipment that could have come into contact with the water from the reservoir. 



## Decontamination

*Be sure to follow the standard operating procedures for your unit.*

1—Flush all discharge ports **first**:

- a. Remove the nozzle from the wand.
- b. Put the tip of the wand against the port opening and flush with 120°F hot water for **one** minute. (The hoses to the ballast tanks are usually three to six feet in length.) 







2—Flush all inlet ports to ballast systems at 120°F low pressure. Ask the boater how many tanks they have and the location of the inlet ports. Remember to turn the decon unit off when repositioning the attachments to prevent excessive wear and damage to the decontamination unit.

- a. Attach the hose to the quick connect attachment on the wand.
- b. Attach the fake-a-lake to the hose.
- c. Adjust the fake-a-lake so it covers the intake port under the boat. 
- d. Turn on the water and then have the boat operator start the intake pump.
- e. Run water in each ballast tank until the exit temperature of the water is 120°F. Some boats will have two tanks that fill from the same intake port.  
If there is no ballast tank discharge pump, flush the ballast tanks with 120°F water for at least 3–5 minutes.
- f. Have boat operator turn off the pump.
- g. Turn off the decon unit while repositioning the fake-a-lake for the next intake port.
- h. Repeat steps c through g for each ballast tank.



3—Flush the engine inlet. This intake always has a screen cover and is located directly under the engine on the hull. 

- a. Adjust the fake-a-lake so that it covers the engine intake port. 
- b. Start the decon unit and start the water.
- c. Stand clear of propeller and have the boat operator start the engine in **Neutral**.
- d. Continue flushing until the exiting water temperature is 140°F.
- e. Have the boat operator turn off the engine.
- f. Turn off the decon unit and remove the fake-a-lake.



4—Flush the bilge with 120°F low pressure water.

- a. Make sure that the bilge plug in the center access area is in.
- b. Add 4–5 gallons of water into the bilge by putting the wand down behind the engine next to the floor. 



- c. Remove the plug and continue to flush until the exiting water is 120°F. ➤
- d. Turn off the water and have the boat operator run the pump to assist in water removal.



5—Flush the strut bearing with 140°F low pressure water; use high pressure if adult mussels are attached. ➤



6—Flush rudder port. ➤



7—Use 140°F high pressure water on the outside of the boat including trailer, inside of wheels and inside the tubes of the trailer. Be sure to turn the pressure down if there are carpeted bunks or decals.



8—Be sure all ballast tanks are as drained as possible by running the pumps until no water comes out. ➤



9—Be sure the boater removes the bilge plugs prior to you performing decontamination. Instruct the boater to put plug back in after decontamination. ➤

10—On the *Watercraft Inspection And Decontamination Activity Log*, be sure to mark the appropriate procedure under the “Results” section.

11—If exiting, apply a green seal and give the boater a properly filled out receipt. Remind the boater to dry.

## What if the boater will not allow an inspection or decontamination?

The goal is to gain the boater's support of the program and process. Do everything that you can to get the boater's support to inspect the boat and either decontaminate on site, if you have a decontamination unit, or provide an escort to take the boat to the closest decontamination site. If the owner is unwilling to cooperate, you will need the assistance of law enforcement officers. Only qualified peace officers can order decontamination, impound, or quarantine a boat when a boater is not cooperative.

### Guidelines concerning impoundment

- If a boater is entering a water body and there is no evidence of mussels or other ANS on the boat, and the boater refuses an inspection, the boat should be turned away but not impounded.
- If a boat is leaving an infested water body and the boater refuses an inspection, then state laws and regulations require that the boat be inspected prior to launching in another water body. If the boat owner is not compliant, call law enforcement to impound the vessel until proper inspection and/or decontamination can be performed.
- If suspected or known mussels or other ANS are present on a boat and the boater will not consent to an inspection or decontamination, or if decontamination equipment is not available or working, then the boat should be impounded until decontamination can be performed. Call a qualified peace officer.

**Do not let an infested vessel leave the inspection station without a peace officer escort if it is infested or you suspect it is infested! If you are not able to detain the vessel until law enforcement can arrive, be sure to have all the boater's information so an officer can follow up.**



## What options does the boater have if the decontamination unit is broken or if our site doesn't have a decontamination unit?

A boat cannot be allowed to transport zebra or quagga mussels or any ANS. If there is a reasonable belief that



the watercraft has ANS present or has five or more gallons of standing water, call the nearest peace officer (e.g. Wildlife Manager, Park Ranger, County Sheriff, etc.) and call your supervisor. If zebra or quagga mussels are confirmed, do not

allow the boat to leave until law enforcement officials arrive. Options include:

- Quarantine the boat on site until a working decontamination unit can be brought there.
- Escort the boat to the nearest decontamination station.
- As an absolute last resort for a boat with standing water and **no** confirmed or suspected mussels or ANS, you could direct the boater to the nearest decontamination station, although this option is not preferred.

Watercraft inspection and decontamination stations are placed at various locations throughout the state. For the most updated list of these sites, call (303) 291-7295 or visit <http://wildlife.state.co.us/Fishing/MandatoryBoatInspections.htm>.

## State Standard Forms

The following pages contain the standard forms used by the Colorado Division of Wildlife and Colorado State Parks.





# State of Colorado

Inspection/Sample #: --CL   
Water Code      Date (month, day, year)      CL #

## HIGH RISK (ANS) INSPECTION FORM

For use on High Risk Trailered Watercraft

Inspection Location: \_\_\_\_\_ Date/Time: \_\_\_\_\_ Water Code: \_\_\_\_\_

Vessel Registration# (CL#): \_\_\_\_\_ Vehicle Tag #: \_\_\_\_\_ Trailer Tag. #: \_\_\_\_\_

### REASON FOR HIGH RISK INSPECTION (check all that apply)

- Out of state registered or used out of state within last 30 days.
- Been in infested waters within last 30 days: \_\_\_\_\_ (Name/State of water). Days since in infested: \_\_\_\_\_
- Leaving infested waters after more than 24 hours at an infested reservoir
- Big/Complex boat       Standing water present       Vol Request       Dirty/Crusty/Slimy below waterline
- Entering/Leaving marina       Other: \_\_\_\_\_

### VESSEL INSPECTION (inspect very methodically and carefully)

Overall look and feel of the hull (check box):

- Clean/Smooth       Bumpy/Sandpaper feel       Other: \_\_\_\_\_  
(if bumpy/sandpaper feel, then look at bumps with magnifying glass to see if mussels)

#### Vessel Exterior Checked

- Entire hull       Trim tabs (top and bot.)       Through hull fittings      **Sailboats:**
- Transom       Transducers       Pitot tubes       Centerboard box
- Anchors and ropes       Depth sounders       Water intakes/Outlets       Rudder and transom
- Water holding pockets       Recessed bolts       PWC—foot recesses       Keel
- Motor well       Cavitations plate(s)       Lights       Fittings

#### Motor Checked

- Exterior housings       Propeller and assembly       Propeller shaft       Prop., shaft supports       Propeller guards
- Rudders       Propulsion system       Lower unit       Gimbel area       Water intake/Outlets

#### Trailer Checked

- Rollers, bunks, pads       License plate       Trailer lights       Trailer wiring       Trailer axels
- Trailer springs       Fenders       Pockets and hollows       Wheels and tires       Hangers

#### Interior/Equipment Checked

- Bait and live wells       Internal ballast tanks       PFD's       Float cushions/belts       Rope and equipment lockers
- Anchors       Waterfowl decoys       Nets       Water skis and ropes       Other equipment

#### Vessel Thoroughly Drained

- Bilge plug or pump       Bait and live wells       Ballast tanks       Drain lower unit on outboard
- Drain inboard motors fully by pulling plugs.       Drain water cooled generators, swamp coolers with plugs

Large boats, **ask driver to activate bilge pump.**

If **entering** a reservoir with **any** standing water and from infested or out-of-state waters in last 30 days, send to decontamination!

If **entering** a reservoir with standing water, require draining. If vessel cannot be drained and has more than 5 gallons, send to decontamination. For lesser volumes of water, assess risk to determine whether to decontaminate.

If **leaving**, drain and educate about Clean/Drain/Dry.

#### Closeout (if nothing is found)

- Ask owner to replace bilge or other plugs       Yell "stand clear"       Thank them for cleaning/draining/drying

### VESSEL INSPECTION FINDINGS (check all that apply)

- Did not find** any identified or suspected ANS species
- Found:**       Large volume of water       Suspected ANS in water       Mussels       Vegetation
- Other: \_\_\_\_\_       Location(s): \_\_\_\_\_

### INSPECTION COMPLETED IN ACCORDANCE WITH STATE PROCEDURES:

Inspected by (print # and name): \_\_\_\_\_

Inspected by (signature): \_\_\_\_\_







# State of Colorado

Inspection/Sample #:  -  - CL   
Water Code      Date (month, day, year)      CL #

## (ANS) DOCUMENTATION and VESSEL DECONTAMINATION FORM (pg.3)

VESSEL EXTERIOR (check all that apply)	Mussels	Vegetation	Other (describe)
<input type="checkbox"/> Entire Hull	<input type="checkbox"/> Yes <input type="checkbox"/> No	<input type="checkbox"/> Yes <input type="checkbox"/> No	<input type="checkbox"/> Yes <input type="checkbox"/> No _____
<input type="checkbox"/> Trim Tabs (top & bottom of hinges)	<input type="checkbox"/> Yes <input type="checkbox"/> No	<input type="checkbox"/> Yes <input type="checkbox"/> No	<input type="checkbox"/> Yes <input type="checkbox"/> No _____
<input type="checkbox"/> Through Hull Fittings	<input type="checkbox"/> Yes <input type="checkbox"/> No	<input type="checkbox"/> Yes <input type="checkbox"/> No	<input type="checkbox"/> Yes <input type="checkbox"/> No _____
<input type="checkbox"/> Motor Well	<input type="checkbox"/> Yes <input type="checkbox"/> No	<input type="checkbox"/> Yes <input type="checkbox"/> No	<input type="checkbox"/> Yes <input type="checkbox"/> No _____
<input type="checkbox"/> Transom	<input type="checkbox"/> Yes <input type="checkbox"/> No	<input type="checkbox"/> Yes <input type="checkbox"/> No	<input type="checkbox"/> Yes <input type="checkbox"/> No _____
<input type="checkbox"/> Transducers	<input type="checkbox"/> Yes <input type="checkbox"/> No	<input type="checkbox"/> Yes <input type="checkbox"/> No	<input type="checkbox"/> Yes <input type="checkbox"/> No _____
<input type="checkbox"/> Pilot Tubes	<input type="checkbox"/> Yes <input type="checkbox"/> No	<input type="checkbox"/> Yes <input type="checkbox"/> No	<input type="checkbox"/> Yes <input type="checkbox"/> No _____
<input type="checkbox"/> Cavitations Plate(s)	<input type="checkbox"/> Yes <input type="checkbox"/> No	<input type="checkbox"/> Yes <input type="checkbox"/> No	<input type="checkbox"/> Yes <input type="checkbox"/> No _____
<input type="checkbox"/> Ropes & Lines	<input type="checkbox"/> Yes <input type="checkbox"/> No	<input type="checkbox"/> Yes <input type="checkbox"/> No	<input type="checkbox"/> Yes <input type="checkbox"/> No _____
<input type="checkbox"/> Anchors	<input type="checkbox"/> Yes <input type="checkbox"/> No	<input type="checkbox"/> Yes <input type="checkbox"/> No	<input type="checkbox"/> Yes <input type="checkbox"/> No _____
<input type="checkbox"/> Depth Sounders	<input type="checkbox"/> Yes <input type="checkbox"/> No	<input type="checkbox"/> Yes <input type="checkbox"/> No	<input type="checkbox"/> Yes <input type="checkbox"/> No _____
<input type="checkbox"/> Water Intakes	<input type="checkbox"/> Yes <input type="checkbox"/> No	<input type="checkbox"/> Yes <input type="checkbox"/> No	<input type="checkbox"/> Yes <input type="checkbox"/> No _____
<input type="checkbox"/> Water Outlets	<input type="checkbox"/> Yes <input type="checkbox"/> No	<input type="checkbox"/> Yes <input type="checkbox"/> No	<input type="checkbox"/> Yes <input type="checkbox"/> No _____
<input type="checkbox"/> Lights	<input type="checkbox"/> Yes <input type="checkbox"/> No	<input type="checkbox"/> Yes <input type="checkbox"/> No	<input type="checkbox"/> Yes <input type="checkbox"/> No _____
<input type="checkbox"/> Water Holding Compartments (pockets, etc.)	<input type="checkbox"/> Yes <input type="checkbox"/> No	<input type="checkbox"/> Yes <input type="checkbox"/> No	<input type="checkbox"/> Yes <input type="checkbox"/> No _____
<input type="checkbox"/> Foot Recesses—PWC	<input type="checkbox"/> Yes <input type="checkbox"/> No	<input type="checkbox"/> Yes <input type="checkbox"/> No	<input type="checkbox"/> Yes <input type="checkbox"/> No _____
<input type="checkbox"/> Centerboard Box—Sailboat	<input type="checkbox"/> Yes <input type="checkbox"/> No	<input type="checkbox"/> Yes <input type="checkbox"/> No	<input type="checkbox"/> Yes <input type="checkbox"/> No _____
<input type="checkbox"/> Rudder and Transom—Sailboat	<input type="checkbox"/> Yes <input type="checkbox"/> No	<input type="checkbox"/> Yes <input type="checkbox"/> No	<input type="checkbox"/> Yes <input type="checkbox"/> No _____
<input type="checkbox"/> Keel—Sailboat	<input type="checkbox"/> Yes <input type="checkbox"/> No	<input type="checkbox"/> Yes <input type="checkbox"/> No	<input type="checkbox"/> Yes <input type="checkbox"/> No _____
<input type="checkbox"/> Fittings—Sailboat	<input type="checkbox"/> Yes <input type="checkbox"/> No	<input type="checkbox"/> Yes <input type="checkbox"/> No	<input type="checkbox"/> Yes <input type="checkbox"/> No _____
<input type="checkbox"/> Other (describe below): _____	<input type="checkbox"/> Yes <input type="checkbox"/> No	<input type="checkbox"/> Yes <input type="checkbox"/> No	<input type="checkbox"/> Yes <input type="checkbox"/> No _____
MOTOR (check all that apply)	Mussels	Vegetation	Other (describe)
<input type="checkbox"/> Exterior Housings	<input type="checkbox"/> Yes <input type="checkbox"/> No	<input type="checkbox"/> Yes <input type="checkbox"/> No	<input type="checkbox"/> Yes <input type="checkbox"/> No _____
<input type="checkbox"/> Propeller & Assemblies	<input type="checkbox"/> Yes <input type="checkbox"/> No	<input type="checkbox"/> Yes <input type="checkbox"/> No	<input type="checkbox"/> Yes <input type="checkbox"/> No _____
<input type="checkbox"/> Propeller Shafts	<input type="checkbox"/> Yes <input type="checkbox"/> No	<input type="checkbox"/> Yes <input type="checkbox"/> No	<input type="checkbox"/> Yes <input type="checkbox"/> No _____
<input type="checkbox"/> Propeller Shaft Supports	<input type="checkbox"/> Yes <input type="checkbox"/> No	<input type="checkbox"/> Yes <input type="checkbox"/> No	<input type="checkbox"/> Yes <input type="checkbox"/> No _____
<input type="checkbox"/> Propeller Guards	<input type="checkbox"/> Yes <input type="checkbox"/> No	<input type="checkbox"/> Yes <input type="checkbox"/> No	<input type="checkbox"/> Yes <input type="checkbox"/> No _____
<input type="checkbox"/> Rudders	<input type="checkbox"/> Yes <input type="checkbox"/> No	<input type="checkbox"/> Yes <input type="checkbox"/> No	<input type="checkbox"/> Yes <input type="checkbox"/> No _____
<input type="checkbox"/> Propulsion Systems	<input type="checkbox"/> Yes <input type="checkbox"/> No	<input type="checkbox"/> Yes <input type="checkbox"/> No	<input type="checkbox"/> Yes <input type="checkbox"/> No _____
<input type="checkbox"/> Lower Units	<input type="checkbox"/> Yes <input type="checkbox"/> No	<input type="checkbox"/> Yes <input type="checkbox"/> No	<input type="checkbox"/> Yes <input type="checkbox"/> No _____
<input type="checkbox"/> Gimbal Areas	<input type="checkbox"/> Yes <input type="checkbox"/> No	<input type="checkbox"/> Yes <input type="checkbox"/> No	<input type="checkbox"/> Yes <input type="checkbox"/> No _____
<input type="checkbox"/> Water Intakes & Outlets	<input type="checkbox"/> Yes <input type="checkbox"/> No	<input type="checkbox"/> Yes <input type="checkbox"/> No	<input type="checkbox"/> Yes <input type="checkbox"/> No _____
<input type="checkbox"/> Other (describe below): _____	<input type="checkbox"/> Yes <input type="checkbox"/> No	<input type="checkbox"/> Yes <input type="checkbox"/> No	<input type="checkbox"/> Yes <input type="checkbox"/> No _____
TRAILER (check all that apply)	Mussels	Vegetation	Other (describe)
<input type="checkbox"/> Trailer Rollers & Bunks	<input type="checkbox"/> Yes <input type="checkbox"/> No	<input type="checkbox"/> Yes <input type="checkbox"/> No	<input type="checkbox"/> Yes <input type="checkbox"/> No _____
<input type="checkbox"/> Trailer License Plate	<input type="checkbox"/> Yes <input type="checkbox"/> No	<input type="checkbox"/> Yes <input type="checkbox"/> No	<input type="checkbox"/> Yes <input type="checkbox"/> No _____
<input type="checkbox"/> Trailer Lights	<input type="checkbox"/> Yes <input type="checkbox"/> No	<input type="checkbox"/> Yes <input type="checkbox"/> No	<input type="checkbox"/> Yes <input type="checkbox"/> No _____
<input type="checkbox"/> Trailer Wiring	<input type="checkbox"/> Yes <input type="checkbox"/> No	<input type="checkbox"/> Yes <input type="checkbox"/> No	<input type="checkbox"/> Yes <input type="checkbox"/> No _____
<input type="checkbox"/> Trailer Axles	<input type="checkbox"/> Yes <input type="checkbox"/> No	<input type="checkbox"/> Yes <input type="checkbox"/> No	<input type="checkbox"/> Yes <input type="checkbox"/> No _____
<input type="checkbox"/> Trailer Springs	<input type="checkbox"/> Yes <input type="checkbox"/> No	<input type="checkbox"/> Yes <input type="checkbox"/> No	<input type="checkbox"/> Yes <input type="checkbox"/> No _____
<input type="checkbox"/> Trailer Fenders	<input type="checkbox"/> Yes <input type="checkbox"/> No	<input type="checkbox"/> Yes <input type="checkbox"/> No	<input type="checkbox"/> Yes <input type="checkbox"/> No _____
<input type="checkbox"/> Trailer Pockets & Hollow Spaces	<input type="checkbox"/> Yes <input type="checkbox"/> No	<input type="checkbox"/> Yes <input type="checkbox"/> No	<input type="checkbox"/> Yes <input type="checkbox"/> No _____
<input type="checkbox"/> Trailer Wheels & Tires	<input type="checkbox"/> Yes <input type="checkbox"/> No	<input type="checkbox"/> Yes <input type="checkbox"/> No	<input type="checkbox"/> Yes <input type="checkbox"/> No _____
<input type="checkbox"/> Hangers	<input type="checkbox"/> Yes <input type="checkbox"/> No	<input type="checkbox"/> Yes <input type="checkbox"/> No	<input type="checkbox"/> Yes <input type="checkbox"/> No _____
<input type="checkbox"/> Other (describe below): _____	<input type="checkbox"/> Yes <input type="checkbox"/> No	<input type="checkbox"/> Yes <input type="checkbox"/> No	<input type="checkbox"/> Yes <input type="checkbox"/> No _____
CONTENTS (check all that apply)	Mussels	Vegetation	Other (describe)
<input type="checkbox"/> Evaporative Coolers	<input type="checkbox"/> Yes <input type="checkbox"/> No	<input type="checkbox"/> Yes <input type="checkbox"/> No	<input type="checkbox"/> Yes <input type="checkbox"/> No _____
<input type="checkbox"/> Water Pump Systems	<input type="checkbox"/> Yes <input type="checkbox"/> No	<input type="checkbox"/> Yes <input type="checkbox"/> No	<input type="checkbox"/> Yes <input type="checkbox"/> No _____
<input type="checkbox"/> Bait & Live Wells, Internal Ballast Tanks	<input type="checkbox"/> Yes <input type="checkbox"/> No	<input type="checkbox"/> Yes <input type="checkbox"/> No	<input type="checkbox"/> Yes <input type="checkbox"/> No _____
<input type="checkbox"/> Equipment & Rope Lockers	<input type="checkbox"/> Yes <input type="checkbox"/> No	<input type="checkbox"/> Yes <input type="checkbox"/> No	<input type="checkbox"/> Yes <input type="checkbox"/> No _____
<input type="checkbox"/> Personal Gear: Ski Gloves, Diving Gear, Clothing & Footwear	<input type="checkbox"/> Yes <input type="checkbox"/> No	<input type="checkbox"/> Yes <input type="checkbox"/> No	<input type="checkbox"/> Yes <input type="checkbox"/> No _____
<input type="checkbox"/> Floats: Float Belts, PFDs, Float Cushions, Water Weenies, Torpedoes, Tubes, Inflatable Pontoons, etc.	<input type="checkbox"/> Yes <input type="checkbox"/> No	<input type="checkbox"/> Yes <input type="checkbox"/> No	<input type="checkbox"/> Yes <input type="checkbox"/> No _____
<input type="checkbox"/> Water Skis & Ropes	<input type="checkbox"/> Yes <input type="checkbox"/> No	<input type="checkbox"/> Yes <input type="checkbox"/> No	<input type="checkbox"/> Yes <input type="checkbox"/> No _____
<input type="checkbox"/> Fishing & Hunting Equipment: Nets, Downriggers, Decoys, Blinds, & other equipment that has entered the water	<input type="checkbox"/> Yes <input type="checkbox"/> No	<input type="checkbox"/> Yes <input type="checkbox"/> No	<input type="checkbox"/> Yes <input type="checkbox"/> No _____
<input type="checkbox"/> Other (describe below): _____	<input type="checkbox"/> Yes <input type="checkbox"/> No	<input type="checkbox"/> Yes <input type="checkbox"/> No	<input type="checkbox"/> Yes <input type="checkbox"/> No _____

# State of Colorado

Inspection/Sample #:     -     - CL

Water Code      Date (month, day, year)      CL #

## (ANS) DOCUMENTATION and VESSEL DECONTAMINATION FORM (pg. 4)

### Specimen Collection and Shipping Instructions

1. Collect specimen carefully to obtain entire organism. Use clean, sterile tools to prevent contamination.
2. Place specimen in screw-capped sample vials. These vials are available through VWR International (1-800-932-5000 or VRW.com) catalog #66010-448 (small vial) or #66012-044 (larger vial). Similar vials are offered through other scientific supply companies such as Fisher, Falcon, and Corning.
3. Immediately fill vial (with specimen) with 70% ethanol.
  - a. Only fill 50% of vial with ethanol to cover specimen and prevent leakage.
  - b. Use 70% reagent alcohol, catalog #RC65910 (VWR International), or equivalent, or made it up from 100% reagent alcohol diluted with deionized or distilled water. Trace amounts of chlorine from tap water, or "dechlorinated" tap water can completely destroy sample DNA.
  - c. Do **not** use formaldehyde.
4. Write the date and location directly on sample tubes with alcohol resistant permanent sharpie marker.
5. Place sample tubes in Ziploc bags.
6. Place Ziploc bag and the completed form (complete with alcohol resistant permanent sharpie marker) below in bubble mailer or padded box.
7. FedEx to DOW Aquatic Animal Health Lab, 122 E. Edison, Brush, CO 80723—ASAP (within 48 hours).
8. Email ReportANS@state.co.us to notify DOW that the sample is being shipped
9. If you have questions, call 303-293-6531 or email ReportANS@state.co.us.
10. Remember to disinfect all collection tools by storing them in acidic acid or vinegar solution.

▼ Remove bottom half of page and include in mailer with vials being shipped to DOW for analysis.

### SUSPECTED (ANS) COLLECTION FORM FOR WATERCRAFT INSPECTION STATIONS

Collector's Name: \_\_\_\_\_

WID Address: \_\_\_\_\_

Phone: \_\_\_\_\_ Email: \_\_\_\_\_

Date of Collection: \_\_\_\_\_ Time of Collection: \_\_\_\_\_

#### REASON FOR COLLECTION (check all that apply)

Visual ID of ANS     Bumps on Boat/Trailer     Plants on Boat/Trailer     Unidentifiable Organic Material

#### LOCATION OF SUSPECTED ANS PRIOR TO COLLECTION

Watercraft Hull     Motor     Live Well     Anchor     Bilge     Watercraft Interior

In Lake/Reservoir     Other: \_\_\_\_\_

Date Mailed: \_\_\_\_\_ ▼ Do Not Write Below Line: **For Lab Use Only**

Date Received at AAHL: \_\_\_\_\_ AAHL ID #: \_\_\_\_\_

Specimen ID: \_\_\_\_\_ Date Identified: \_\_\_\_\_

Technician: \_\_\_\_\_ Further Analysis Needed: \_\_\_\_\_

Collector Contacted with Results: \_\_\_\_\_

# State of Colorado

## INSPECTION AND DECONTAMINATION SEAL RECEIPT

For use when applying green seals to boats.  
Provide original to watercraft owner (white) and keep carbon copy (yellow).

Location: _____
Date/Time: _____
Inspector's ID #: _____
Vessel Registration (CL #): _____
Seal Serial #: _____
<b>SEAL AND INSPECTION TYPE</b>
Clean, Drain, Dry Inspection: <input type="checkbox"/> Performed or <input type="checkbox"/> Not Performed
High Risk Inspection: <input type="checkbox"/> Performed or <input type="checkbox"/> Not Performed <i>(High Risk Inspection minimum at containment reservoirs)</i>
Full Decontamination: <input type="checkbox"/> Performed or <input type="checkbox"/> Not Performed
Standing Water Decontamination: <input type="checkbox"/> Performed or <input type="checkbox"/> Not Performed
Plant Decontamination: <input type="checkbox"/> Performed or <input type="checkbox"/> Not Performed
Bait Treatment: <input type="checkbox"/> Performed or <input type="checkbox"/> Not Performed
<b>HOW TO TREAT A BOAT WITH GREEN SEALS</b>
Cut off seal and let boat launch if:
1.) Boat is returning to the same location; or
2.) Boat has been out of the water for more than 30 days; or
3.) Boat is clean and fully drained.
If not, perform an inspection prior to launch.
<b>THANKS—Please save this receipt and dry your boat.</b>

**Distribution:** White—Owner/Operator    Yellow—Inspection Location  
2/2011 – 80,000    11-2698322/2783FY1

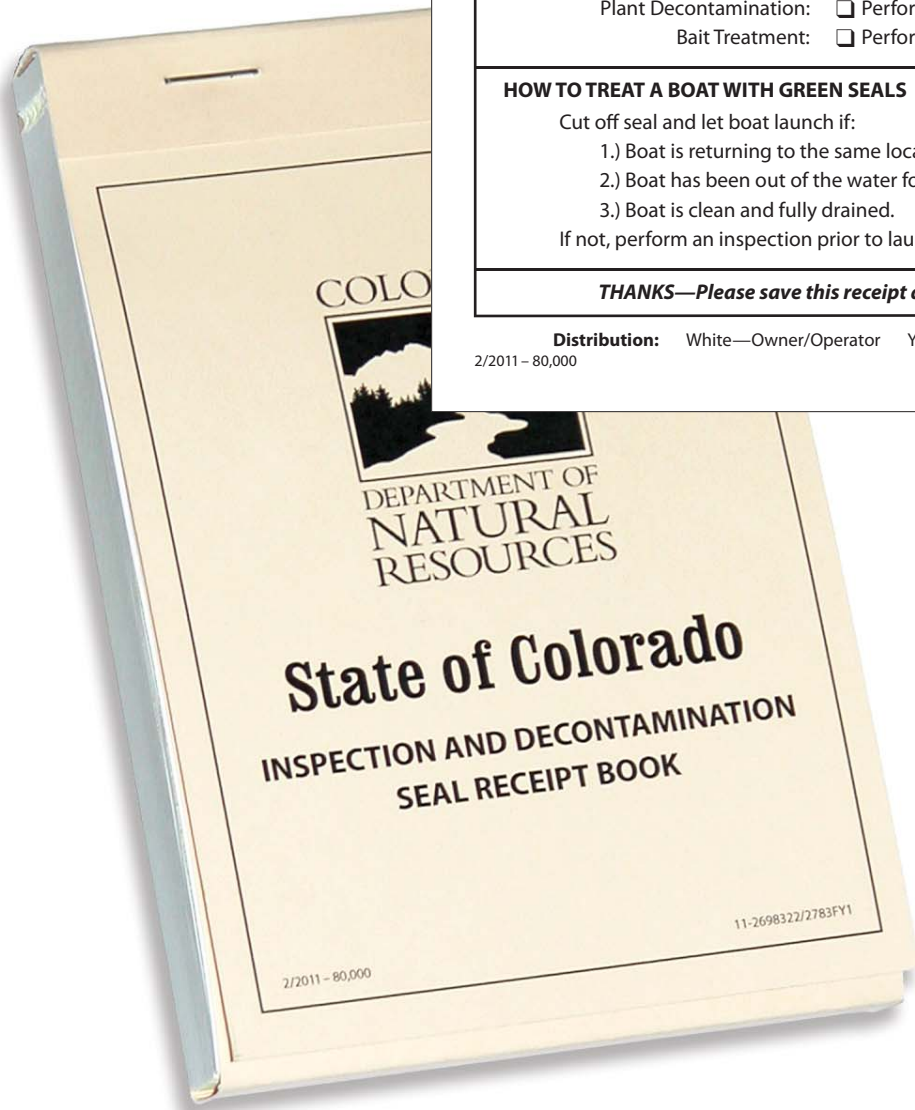





# Winterizing Procedures for Decontamination Units

## Step-by-Step Instructions for Trailered Hydro Tek Units

### Objective

To winterize the units without the need to drain the water tank. This allows units to be kept at remote sites and “ready” with the necessary water to perform decontaminations when the water temperature is dropping below freezing during working hours or overnight.

### Materials Needed

- Two gallons of RV/Marine antifreeze
- One 2–3 gallon plastic container/tank
- One three-way valve
- Adapters, barbed fittings, Teflon® tape, and clamps for attaching tank and valve to hoses
- Bulkhead for plastic container if needed

An example of container with bulkhead and 3-way valve



The function of the three-way valve is to have the smaller antifreeze supply isolated from the water supply. The operator is able to “switch” back and forth between the water supply and antifreeze by turning the handle 90° as shown.



Valve position for antifreeze



Valve position for water

## Install a 3-Way Valve if One is Not Already on Unit

1—Cut water supply line about 20 inches from the filter.

2—Attach water supply line to three-way valve.



3—Cut other side of supply line and attach to valve.



4—Cut about **five inches** of hose and attach the antifreeze container to the third port of the three-way valve.



## Winterize the Decontamination Unit

1—Roll out **six feet** of pressure hose and secure the trigger in the **open** position.



2—Fill the container with two gallons of antifreeze.





## Step-by-Step Instructions for Trailered Hydro Tek Units (cont.)

3—Start up Hydro Tek unit and run the pump (no heat) until the colored antifreeze comes out of the gun. Shut down unit following the standard operating procedures.

*Note: When switching the valve back to the water supply for decontamination, it is possible to recycle the two gallons of antifreeze which is in the machine and hose before the water begins to flow.*



4—Connect supply hose and store with trigger in elevated position for winter to avoid antifreeze siphoning out.

5—Be sure to drain the water tank at the end of the season before storing in a secure location.



## Step-by-Step Instructions for Non-Trailer Hydro Tek Units

### Objective

To winterize the units and allow them to be kept ready for daily use for performing decontaminations when the water temperature is dropping below freezing during working hours or overnight.

### Materials Needed

- Two gallons of RV/Marine antifreeze
- One zip-tie



### Instructions

1—Pour a minimum of two gallons RV/Antifreeze into the holding reservoir.



2—Depress the trigger and secure it with a zip-tie.



3—Turn on the unit (**no heat**) and run it until antifreeze comes out through the trigger.

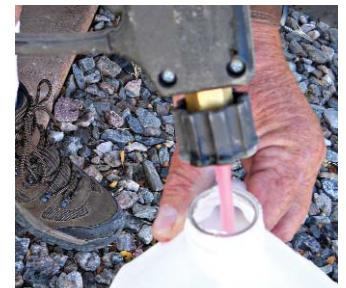



## Step-by-Step Instructions for Non-Trailer Hydro Tek Units (cont.)

4—Store unit with the trigger elevated above the reservoir.



### To Operate a Winterized Unit:

Begin by recycling the antifreeze into a clean container. When the water runs clear the unit is ready to use. It may be possible to re-use the antifreeze. A winterizing kit can also be used. This kit allows the decontamination unit to be winterized for protection. However, if it needs to be used for a decontamination, the operator just turns the yellow handle 90°, starts the unit (**no heat**) and recycles the antifreeze back into the red container. The unit is then ready to go. When finished with the decontamination, the operator turns the yellow handle back to the position shown in the photo and runs the unit (**no heat**) until the pink colored antifreeze comes out of the spray gun.





# Step-by-Step Instructions for Mi-T-M Units

## Objective

To winterize the units without the need to drain the water tank. This allows Mi-T-M units to be kept at remote sites and “ready” with the necessary water to perform decontaminations when the water temperature is dropping below freezing during working hours or overnight.

## Materials Needed

- Two gallons of RV/Marine antifreeze
- One male and one female ¾ inch barb to hose thread fittings
- One set of quick connect hose adapters
- Funnel and clamps for attaching adapters



An example of barbed fittings and quick connect.



Exploded view



Assembled view

## Instructions

1—Cut water supply line between tank and pump.



2—Attach hose fittings and quick connect.

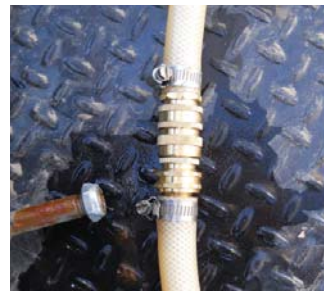
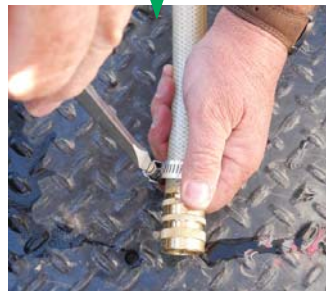

## Step-by-Step Instructions for Mi-T-M Units (cont.)

3—Secure the pump side of the quick connect to the frame of unit in elevated location. Attach the hose to pour the antifreeze in.



4—Prime hose by pouring in antifreeze.



5—Roll out **six feet** of pressure hose and secure trigger in the **open** position.





6—Start engine and pour antifreeze into funnel until fluid runs out through trigger.



7—Connect supply hose and store with trigger in elevated position for winter to avoid antifreeze siphoning out.



8—Be sure to drain the water tank at the end of the season before storing in a secure location.



# Decontamination Unit

## Photo Glossary

**Burner on/off switch**—This switch activates the burner to heat the water. Squeeze the trigger on the spray gun and the burner will begin heating the water. It will stop firing whenever the water spray is off or if the temperature setting is exceeded. After turning the switch off, be sure to run water through the system to cool the boiler.



**Choke**—When first starting the decontamination unit, pull the choke out and turn the key until the engine starts. Push the choke in immediately after the unit starts.



**Diffuser**—This attachment connects directly to the spray gun and is used to decontaminate discharge ports, soak carpeted areas on the boat and/or trailer and standing water flushes for any interior compartments. It provides low pressure and a rubber tip to prevent scratching any surface.



**Dual lance wand**—This attachment connects directly to the spray gun. The other end has a quick connect fitting so that a nozzle or connecting hose can be “quickly” attached by pressing down the outer ring and pressing the “other half” of the quick connect fitting into its center. The handle, when turned clockwise, directs the water through the lance with the quick connect fitting only. If a nozzle is attached the water exiting the wand will be at high pressure. The handle, when turned counter clockwise, directs the water through both lances and lowers the pressure of the water. A dual lance wand can be used for low pressure standing water flushes if there is no nozzle attached and the water is exiting both lances.



**Fake-a-lake**—This attachment is used for decontaminating inboard engines and ballast tanks. It has a telescoping leg and the hose attachment threads into the connection on the “plunger,” joining the fake-a-lake to the hose to the wand.



**Hose for connecting attachments**—This six foot hose has a quick connect fitting that connects to the end of the wand. The other end threads into the fake-a-lake or muff attachments needed for a decontamination.



**Hydro Tek trailered decontamination unit**—Hydro Tek units have both a key and pull start option. It has a thermostat for adjusting water temperature. It does not have a water shut off valve between the tank and the pump. Therefore, the tank must be empty to remove the water filter for maintenance.



**Hydro Tek non-trailered decontamination unit**—These units are identical to the trailered units listed above but they do not have a water tank attached and are not loaded on a trailer.



**Laser thermometer**—This thermometer is invaluable to the decontamination process. It is used to initially test the temperature of the water prior to the decontamination. It is also used to check the exiting water temperature when performing a standing water decontamination for interior compartments and engine flushes.





**Mi-T-M trailered decontamination unit**—Mi-T-M units have a pull start only option. They do **not** have a thermostat to adjust the water temperature. They do have a water shut off valve so that the water filter can be cleaned even with water in the tank.



**Muffs**—Muffs are used to decontaminate the lower unit of an outboard motor or inboard/outboard engine. The muffs pictured at the top of the photo are used for all new models of the outboard motor and inboard/outboard Mercury engines that have intake ports that are open. The lower muffs are used on all other outboard motors and inboard/outboard manufacturer's engines.



**Nozzle and nozzle storage**—The Nozzle Storage area shows the degree of the nozzle written below the nozzle and its spray pattern is shown above the nozzle. The preferred spray pattern is 40°. Nozzle color and degrees can vary by manufacturer. A nozzle is attached to the end of the wand with the help of the quick connect fitting. Be sure the quick connect “clicks” into place when attaching the nozzle. Point the wand and nozzle towards the ground when you first engage the trigger to start the water. This is a safety issue and will ensure that no one or nothing will be hurt or damaged if the nozzle blows off the wand.



***Note:** All red colored nozzles (0°) have been removed and should **never** be used for boat decontaminations. The 15° nozzles are also not recommended.*

**Oil dip-stick for the decontamination unit's engine**—This should be checked prior to every use. Use 30-weight detergent oil to keep the oil reservoir topped off.





**Oil dip-stick for the decontamination unit's pump—**

This should be checked prior to every use. Pump oil is used to keep the oil reservoir topped off.



**Quick connect fitting—**This fitting comes in two parts.

The part that is attached to the end of the wand has to have the external circle pressed down before the “male” portion of the fitting can be inserted. The external circle then must “click” in place to make a proper connection.



**Spray gun with trigger—**This photo of the gun has the trigger “wired” open due to unit having been winterized. The wand or the diffuser attachment thread directly onto the gun.

**CAUTION:** *The spray gun kicks back when the trigger is engaged—hold with both hands.*



**Thermostat—**The thermostat allows the water temperature to be adjusted so that different decontamination temperature protocols can be adhered to by the inspector. Every machine's temperature is different depending on the altitude of its location and the temperature of the water in the tank. Be sure to test the temperature of the water with a digital thermometer prior to beginning and during all decontaminations.



**Water shut off valve on the Mi-T-M unit—**This valve shuts off the water supply to the unit. This allows for maintenance of the water filter pictured here to the left of the shut off valve. The shut off valve is in the off position (red handle) in this photo.





# Acknowledgements

The Colorado Division of Wildlife would like to thank the following people and companies for their assistance with this decontamination manual. With their help we were able to provide current and accurate information.

**Michael Collins**

Johnson Pumps of America

**Dave Harfst**

Service Manager  
Tommy's Slalom Shop  
Denver, CO

**Wendy Inskip**

Product Manager  
Marine Specialty/OEM Group, Pentair Water

**Michael Irving**

Associate Product Manager  
Rule, Jabsco, and Flo Jet, ITT Flow Control

**Chad Keskitalo**

Compliance Specialist  
Lund Boat Co. & Crestliner Boat Co.

**Jamie Marentette**

Attwood Corporation

**Ross Robinson**

U.S. Marine Customer Service  
Bayliner, Maxum, and Trophy Boats

**Pat and Shelly Ryan**

Best Marine Service  
Wheat Ridge, CO

**Tony Sherlock**

Bass Pro Shops/Tracker  
Denver, CO





## **STOP AQUATIC HITCHHIKERS!™**

This manual was made possible by a grant from



ALL PHOTOS © DOW ANS PROGRAM UNLESS OTHERWISE INDICATED



*Keeping Colorado Wild*

The Colorado Division of Wildlife is the state agency responsible for protecting and managing wildlife and its habitat, as well as providing wildlife-related recreation. The Division is funded by hunting and fishing license fees, federal grants, and Colorado Lottery proceeds through Great Outdoors Colorado.