



COLORADO
Energy Office



Colorado PRV-Hydropower Assessment

JUNE 2016



Prepared by:



**2000 S. Colorado Blvd.
Suite 2 - 1000
Denver, CO 80222
(970) 403-0714**



Colorado Energy Office — Colorado PRV-Hydropower Assessment



COLORADO
Energy Office

PROJECT DESCRIPTION

The Colorado Energy Office (CEO) contracted Amec Foster Wheeler Environment & Infrastructure, Inc. (Amec Foster Wheeler) to prepare a PRV-Hydropower Assessment to highlight hydropower opportunities within water utility delivery systems where pressure reducing valves (PRVs) are used to reduce water pressure. CEO provided specific project description and objectives in its solicitation (Colorado PRV-Hydropower Assessment). Municipal water supply systems are often fed by gravity because a water supply reservoir is commonly located at a higher elevation. In many cases, this results in excess pressure with water supply lines that is typically reduced using a PRV. PRVs are commonly used in water systems to reduce the pressure of water flowing between zones of the water system, and to reduce pressure to a level appropriate for use by water system customers. PRVs can be applied in man-made water conduits-canal, irrigation ditches, aqueducts, and pipelines. When excess pressure is not needed or otherwise is reduced, it provides an opportunity for small hydroelectric generation. By harnessing what would have been wasted energy, water delivery organizations can reduce their own electric demand that is used during operations and even generate additional revenue.

In preparing the assessment, Amec Foster Wheeler enlisted the expertise of Advanced Energy Systems, LLC and Community Hydropower Consulting, LLC and investigated four main elements:

- Research recent advancements of innovative hydropower technologies,
- Create an interactive geoportal for developing a comprehensive list of the water delivery organizations within Colorado,
- Project the estimated hydropower potential in Colorado where PRVs are currently installed.
- Create two detailed case studies of potential PRV-hydropower projects.

The estimated PRV-hydropower potential in Colorado and two detailed case studies relied on the information provided through the interactive geoportal by water providers. Site visits and interviews with water providers were performed for the two detailed case studies. Professional judgments were made where information was incomplete.



DISCLAIMER

This assessment was prepared for CEO for internal use and information dissemination. CEO does not:

- Make any warranty or representation—expressed or implied—with respect to the accuracy, completeness, or usefulness of the information contained in this assessment,
- Assume any liability with respect to—or damages resulting from—the use of the information disclosed in this assessment, or
- Imply endorsement of the information mentioned in this assessment.

Table of Contents

Executive Summary	6
1 Background	7
Hydropower Overview.....	7
Small Hydropower in Colorado.....	7
Hydropower and Pressure Reducing Valves.....	7
2 Hydropower Equipment Innovations	8
Hydropower Turbines.....	8
Equipment Providers and Innovations.....	8
Canyon Hydro.....	8
Rickly Hydro.....	8
SOAR Technologies, Inc.....	8
Toshiba Hydro.....	8
Cornell Pump Company.....	9
Foreign Turbine/Generator Unit Suppliers.....	9
3 Water Provider and PRV Inventory	10
Colorado PRV-Hydropower Geoportal.....	11
PRV INVENTORY.....	12
4 Statewide PRV Hydropower Potential	14
Assumptions Used for Determining the Hydropower Potential.....	14
Determination of the Statewide PRV Hydropower Potential.....	14
5 Detailed Case Studies	15
North Table Mountain Water and Sanitation District.....	15
City of Montrose.....	15
6 Potential Barriers to Development	16
7 Next Steps and Potential Solutions to Barriers	17
Further Development of the PRV Inventory and the Geoportal.....	17
Availability of Funding for Detailed Case Studies.....	17
Attachment 1: Detailed Case Study #1	18
Attachment 2: Detailed Case Study #2	25



Executive Summary

This project kicks off the development of a central repository of information on Colorado statewide water systems, PRVs with hydropower potential, and case studies for utilizing available hydropower at these locations.

A preliminary review found 433 water and sanitation districts (473 including water conservation districts) serving over 5 million people spread over 100,000 square miles in the state, with an estimated 70 percent utilizing surface water, and 60 percent having sufficient source topography to

require pressure reduction within their systems. That could translate into an estimated 1,000 to 5,000 opportunities for hydropower generation with a potential installed capacity of about 25 MW.

Two detailed case studies included in this assessment examine the potential engineering, economics, and related impacts of diverting the PRV flows into hydropower generation, with favorable results.

1 | Background

Hydropower Overview

Hydropower is America's largest source of renewable energy, a technology that has been operational for over 100 years. Most of the recent development and investment in the hydropower industry has been in small hydro (<5MW) without the need of constructing new dams. Hydropower is one of the few renewable technologies that can compete on price and reliability with fossil-based generation. Hydropower is America's largest clean, renewable energy resource, accounting for 49 percent of domestic renewable generation and 6 percent of our total electricity generation in 2015, according to the U.S. Energy Information Administration. Properly designed and operated, hydropower projects typically have one of the lowest Operation and Maintenance (O&M) costs as well. Also, hydropower projects have an expected life of 50 - 80 years before any major refurbishments are needed. Thus they are an inflation-proof generation technology. Please see Figure 1 below for more information.

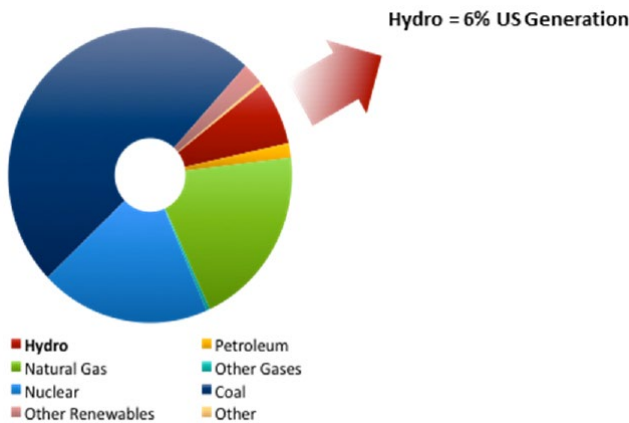

FIGURE 1: U.S. ENERGY PORTFOLIO

Small Hydropower in Colorado

Small hydropower typically takes advantage of existing infrastructure, including already-constructed dams, irrigation canals and pipelines, to generate clean energy with minimal environmental impact. The Colorado Small Hydro Association estimated in 2013 that there is a total of 200 MW of new hydropower development potential in Colorado, translating to approximately 1,000 new jobs. CEO has a long history of assisting those interests in developing hydropower, including but not limited to, small and micro hydropower systems, agriculture hydropower systems, and

conduit hydropower systems. Past initiatives sponsored by CEO include but are not limited to:

- 2007 Renewable Energy Resource Assessment
- 2009 Hydropower seminar
- Renewable Energy Development Team
- Founding the Small Hydro Working Group
- Streamlined Permitting MOU with FERC
- Small Hydropower Pilot Program

Hydropower and Pressure Reducing Valves

This assessment focused on existing water provider conduit systems that utilize PRVs. PRVs are utilized in water distribution systems to reduce pressure (head) due to elevation change. Water pushes against a spring (spring-loaded), air (dome-loaded), or a system that combines the two within a PRV and dissipates energy, thereby reducing the pressure downstream of the PRV. These PRVs can be replaced with small hydropower systems that capture the energy dissipated in a PRV and convert it to usable energy. Conduit systems can be a smart economic decision. With an existing water supply, most of the infrastructure for a hydropower system is already in place, including the intake, penstock, and sometimes even the powerhouse in the form of an existing vault. The relatively low incremental cost of the turbine means the system can pay for itself much earlier than an all-new hydro project. In these systems, hydropower units can be used in both low and high head systems with pressure differentials from about 25 pounds per square inch (PSI) to over 1000 PSI and flows from 100 gallons per minute (GPM) to over 60,000 GPM. The electricity generated from the hydropower unit can be utilized to offset demand at the water provider facility, nearby-owned industrial facility, or can be grid-connected to sell excess power to the local utility.

2 | Hydropower Equipment Innovations

Hydropower Turbines

The Colorado Small Hydropower Handbook describes the two main turbine categories: impulse and reaction turbines. Impulse turbines are generally well suited for high head, low flow applications, and reaction turbines are generally better suited for lower head, high flow applications. There are usually several types of turbines that are capable of operating at a given design flow although they will likely differ in efficiency or range. Specialty conduit hydroelectric equipment that is designed to maximize power generation from water systems is available on the market. Fixed-flow turbines are available but typically operate at a single design point in an on-off configuration and have a fixed rate of flow. Variable flow turbines operate over a wide flow range and can typically recover more energy than a fixed-flow turbine due to higher efficiencies over a wide flow range. Variable flow turbines are available in vertical shaft orientations with in-line flanges to reduce the equipment footprint and installation costs. Maintenance for the hydroelectric equipment is similar to that of a pump, which most water system providers handle on a regular basis. Figure 40 in the Colorado Small Hydropower Handbook shows the operating envelopes for the primary turbine types, and is presented below.

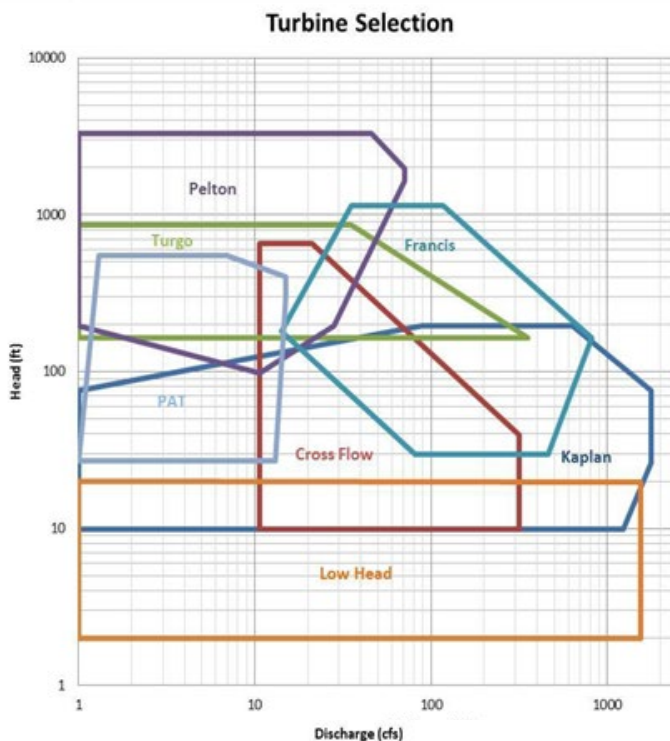

Equipment Providers and Innovations

There are many hydropower equipment providers. Several have been selected and presented below because they promote hydropower equipment specifically for PRV replacement and/or provide innovations for these applications. The list below is provided for information only and is not comprehensive, nor is it an endorsement of the manufacturers.

Canyon Hydro

Canyon Hydro is a manufacturer in Deming, WA that specializes in hydroelectric equipment. It provides specialized hydropower systems designed to integrate with existing water supply (or waste) lines. These "conduits projects" commonly use a turbine to perform the function of a pressure reducing valve. As with a PRV, hydropower turbine reduces pressure. Instead of dissipating this excess energy like a PRV, the turbine converts it to usable power.

Rickly Hydro

Rickly Hydro is a manufacturer in Columbus, OH that advertises complete pressure reducing turbine (PRT) systems. These systems may still be in development as there are no specific turbines or product overviews shown on the website (www.ricklyhydro.com/prt-hydropower-systems/).

SOAR Technologies, Inc.

SOAR Technologies specializes in conduit hydropower. The most common applications for SOAR's products are at PRV locations already in water systems. They provide hydropower equipment ranging from multi-stage grid-tied vertical turbines down to micro hydro turbines designed to power electrical devices inside a standard water system vault with either 12 or 24 volt power - ideal for isolated or confined locations.

Toshiba Hydro

Toshiba Hydro offers a series of micro-to-medium propeller turbines ("e-Kids") that are well-suited for conduit flow. The most common applications for these products are at PRV locations already in water systems. These turbines handle low-to-medium pressures and can be cascaded in series for high-head conditions.

Cornell Pump Company

Cornell Pump Company carries a wide-range of micro-to-medium reverse-pump turbines that are well-suited for conduit flow. Similar to the Toshiba e-Kids, Cornell pumps are available for low-to-medium flows, but prefer a narrow operating range for each model. These units require relatively little space, and thus make good candidates for PRV replacement in tight vaults.

Foreign Turbine/Generator Unit Suppliers

Economic and reliable small turbine/generator units are readily available on the international market because hydroelectric generation is a mature technology (for example, Far East Power Engineering, China).



3 | Water Provider and PRV Inventory

The Amec Foster Wheeler team initiated the PRV-Hydropower Assessment by compiling an inventory of water providers throughout the state. We collected boundary, contact, and water source information where available for these entities, and assembled the data into a geodatabase.

To develop water-provider service area boundary information, we collected available GIS layers from numerous sources and, in some cases, converted analog images to digital GIS files. After extensive research and outreach, we were able to map service areas and collect basic information for 473 total water providers in the inventory. The map below shows the distribution of entities mapped (water conservation and conservancy districts are not shown as they overlap and would block from view many of the smaller water providers).

The following attributes were collected, where possible, for the water providers: name, type, county, water division, population in service area (estimated from 2010 Census block data), water source, contact name, address, email, phone number, comments regarding contact name's title, and secondary address.

Once the water provider inventory was completed to the maximum practicable extent, Amec Foster Wheeler invited each entity to participate in our statewide inventory and assessment of pressure reducing valves (PRVs) and small hydropower development potential. Emails and/or letters were sent to all the water providers in our database asking them to visit our online 'geoportal' to confirm information about their entities, PRVs in their water systems, and level of interest in small hydropower. As further incentive for participation, water providers that entered PRV information within the initiative's timeline were eligible to be selected for a no-cost Feasibility Cost Study.

Now that a comprehensive water provider inventory has been compiled, and water entities have access to an online mapping tool that allows for entity and system information to be easily updated, CEO should expect to be able to continually improve and enhance the water provider database going forward if continued participation is encouraged.

COLORADO WATER PROVIDERS IN THE INVENTORY

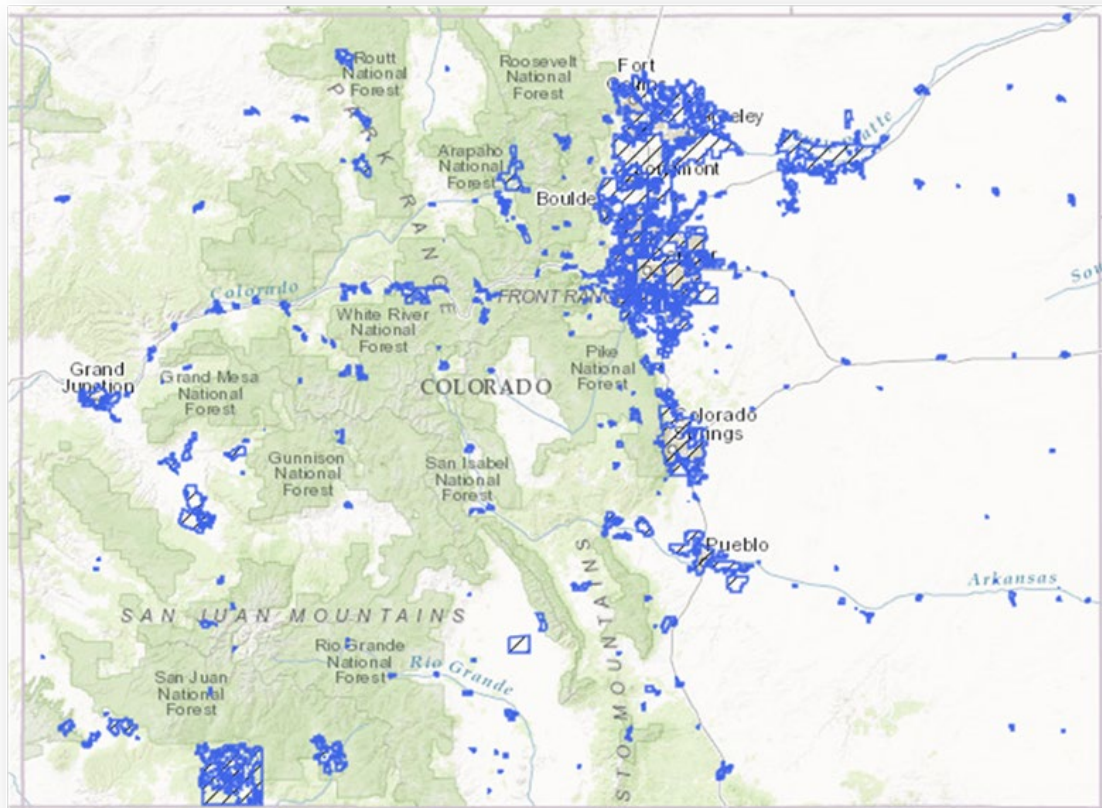

Colorado PRV-Hydropower Geoportal

In order to facilitate data collection and provide visual access to relevant data, Amec Foster Wheeler developed an online mapping application called a geoportal. The Colorado PRV-Hydropower Geoportal is designed to collect/confirm water-entity information, collect basic PRV information, and allow users to calculate nominal hydropower capacity for each PRV.

The geoportal has limited, secure access so that CEO has control over site-users and so that information is protected. Upon login, users are greeted with a series of pop-up information collection screens that walk them through the essential information needed for the inventory and assessment. First, users are asked to enter or confirm contact, entity type, boundary, and water source information. They are also asked whether their system contains any PRVs, and if they have any interest in small hydropower opportunities.

Next, users are prompted to add their PRVs to the map. The tool allows users to draw a point, enter coordinates, or upload multiple PRVs from a file. After a PRV is added to the map, the 'Nominal Generation Calculator' tool window pops up to guide the user through basic data entry. This tool collects the essential information required to identify a PRV and to estimate its nominal generation capacity. Though much more information could potentially be collected for each PRV, we narrowed the focus to only what was critical at this stage to make it quick and easy for users to enter what was needed for our assessment, and to provide them with an instant nominal generation estimate.

The 'Nominal Generation Tool' collection form is shown below:

The screenshot shows a web form titled "Add PRV Tool" with a sub-header "Step 2: Nominal Generation Calculator". The form contains several input fields and a "Calculate" button. The fields are: PRV Name/ID (text input), Waterline Type (dropdown menu with options: Raw water, Treated water, Waste water, Other), Describe if Other (text input), Location Description: (Manhole, service building, etc) (text input), Upstream pressure (psi) (text input), Downstream pressure (psi) (text input), AND/OR (text input), Upstream elevation (feet) (text input), Downstream elevation (feet) (text input), Typical flow rate, GPM (single value) (text input). Below these fields is a section titled "Calculate Hydropower Nominal Capacity" with two rows: "Hydropower Nominal Capacity Pressure:" and "Hydropower Nominal Capacity Elevation:", each followed by a text input field. At the bottom right of this section is a "Calculate" button. Below the form is a section titled "Add attachment(s):" with a note: "This tool supports multiple file uploads. Please upload as much descriptive info as possible."

Once PRV-entry is complete, users can interact with the information directly on the map. Features can be identified, selected, and edited in the map or by using the associated attribute tables, as shown in the following two images.

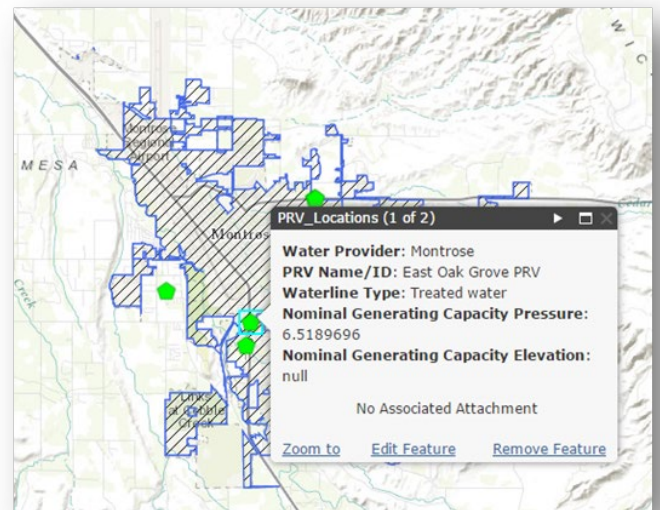

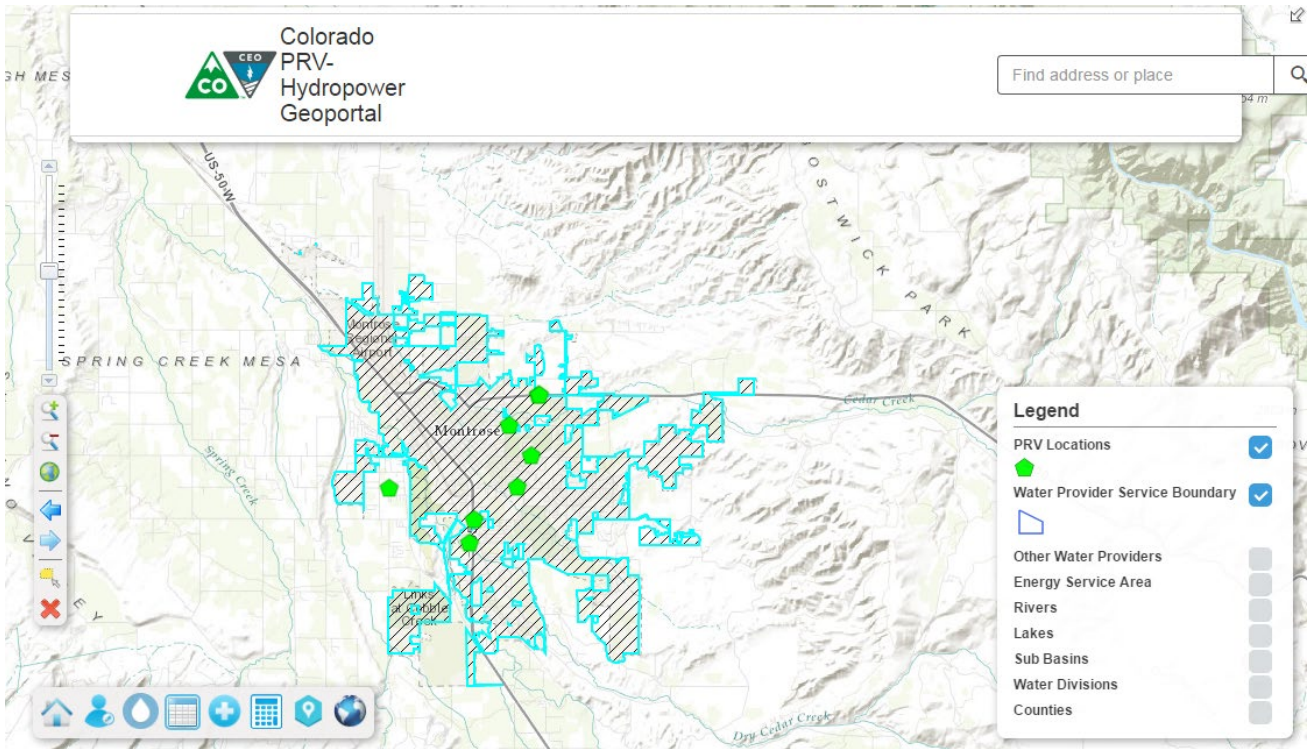

Showing Table For: **PRV Locations** 8 Records 0 Selected Options: **Show All Records**

PRV Name/ID	Waterline Type	Nominal Generating Capacity Pressure	Nominal Generating Capacity Elevation
Sunnyside PRV - low flow	Treated water		
Hwy 50 high	Treated water		
Hwy 50 low flow	Treated water		
Miami Road - low flow	Treated water		
East Oak Grove PRV	Treated water	6.5189696	
Commercial Way PRV - low flow	Treated water		
Orchard PRV - low flow	Treated water		
Niagara PRV	Treated water		

PRV INVENTORY

Water provider participation was limited, but quite good considering the short timeframe for response. Prior to the deadline for case-study selection, 15 entities had responded. Since then, seven more have added information. In total, 334 PRVs were collected in the inventory to date. Of those, only 11 had enough attributes provided for us to be able to complete the nominal generation calculation.

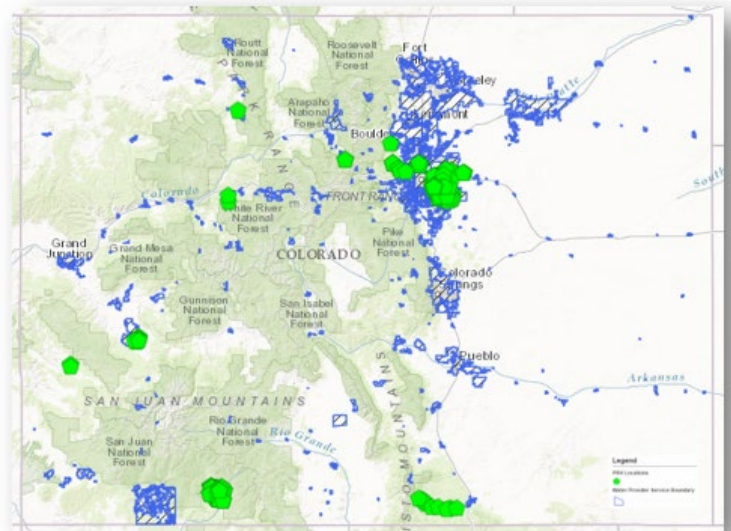

These entities directly participated in the inventory via the geoportal or contact with Amec Foster Wheeler staff:

Water Provider Name	PRVs Mapped / Reported by Entity	Complete Information	Partial Information
Montrose	8 / 8	Yes	Yes
North Table Mountain W&S	3 / 3	Yes	Yes
Delta	0 / 4	No	No
Yuma	0	No	No
Nucla	2 / 2	No	Yes
Gypsum	2 / 2	No	Yes
Morrison Creek Metro. W&S	1 / 1	No	Yes
Aurora	160 / 160	No	Yes
Pagosa Area W&S	130 / 130	No	Yes
Genesee W&S	0	No	No
Indian Hills Water	0	No	No
Louisville	0 / 2	No	No
Steamboat Springs	0 / 6	No	No
<i>After deadline:</i>			
Winter Park W&S	2	No	Yes
Parkville Water	13 / 13	No	Yes
City of Greeley	0 / 40	No	No
Trinidad	9 / 9	No	Yes
Mountain Village	0	No	No
Federal Heights	6 / 6	No	Yes
Boulder	2 / 2	Yes	Yes

Several entities expressed interest and are working to gather PRV data for the assessment effort, but have not yet provided data. These include Denver Water and Westcreek Lake Water District.

Fifteen of the 17 responding entities expressed interest in small hydropower development.

Through our research, outreach, and data-assembly efforts, Amec Foster Wheeler assembled some feedback and observations about the process. In general, users found the geoportal easy to navigate and use. They liked the mapping tools and the stand-alone calculator that allows users to play with hypothetical values. Those that provided feedback liked the look and 'feel' of the geoportal, and were supportive of the potential value of the assessment project.

Some entities expressed concern about the tight response time frame for being short-staffed needing time to track down and assemble PRV data, and needing to gain approval for sharing the information. In addition, some water providers may be under the impression that they could only participate during the study time frame. Additional responses may be received if CEO were to communicate that the geoportal is continually open to input.

Some entities initially expressed concern about permissions/approval to provide the data, but seemed satisfied when assured that the geoportal is secure. Primary complaints and concerns expressed by water providers centered on:

- Short time frame for inventory
- Limited number of PRVs being selected for the study
- Forgetting and needing assistance with login process

Outreach to additional entities may be useful. Often the PRVs are contained within systems other than the water delivery system, or are handled by other departments. For example, large municipalities may have a raw water delivery and treatment department and a public utilities department. One or the other department may have opportunities, but the letter was sent to the other department.

In addition, there were some water-related entities for which we were unable to obtain valid contact information. If emails were not deliverable, Amec Foster Wheeler mailed a letter as well if a mailing address was available. In total, we received returned mail for eight entities and had invalid email addresses (with no mailing address) for four entities. These entities will require additional research to correct their contact information.

NAME	Interest	Notes
Aurora	High	We have high interest - especially if it makes financial sense to do so.
Delta	High	
Genesee W&S	High	
Louisville	High	
Montrose	High	
Morrison Creek Metro. W&S	High	
Mountain Village	High	
North Table Mountain W&S	High	
Nucla	High	
Pagosa Area W&S	High	
Steamboat Springs	High	
Trinidad	High	
Winter Park W&S	High	
Boulder	Moderate	Interest in developing on one PRV
Federal Heights	Moderate	Moderate Interest - Staff availability and involvement is limited
City of Greeley	Low	
Parkville Water	Low	



4 | Statewide PRV Hydropower Potential

Information supplied by the water providers in the PRV inventory was utilized to project a statewide hydropower potential resulting from the replacement of PRVs with hydropower systems. The time frame and limited budget to complete the first stage of the inventory prevented a statistically significant projection of the statewide potential. However, given the short time frame, several water providers supplied information that is useful in determining a preliminary estimate of the statewide potential. As more water providers supply information, the projection can be refined.

Assumptions Used for Determining the Hydropower Potential

In order to determine the statewide hydropower potential from replacing PRVs, several assumptions were employed.

- Complete information was not available for the water conservation and conservancy districts. Therefore, the estimate does NOT count the water conservation and conservancy districts.
- Most of the water providers in or adjacent to mountains or foothills will have pressure differentials within their water supply system significant enough to replace existing PRVs with hydropower systems. (Estimate 55 percent of 430 = 237 are in foothills and mountains - estimate that 90 percent of 237 have a PRV with an opportunity for hydropower = 214)
- A minority of the water providers in the plains regions of the state will not have pressure differentials within their water supply system significant enough to replace existing PRVs with hydropower systems, while a similar minority will have that opportunity. (Estimate 45 percent of 430 = 193 are in plains - estimate that 30 percent of 193 have a PRV with an opportunity for hydropower = 58)
- Pressure differentials for the above systems were assumed to be similar to the two detailed case studies described in the following section. (Estimate 65 psi)
- Flow rates for the above systems with significant pressure differentials were estimated based on water consumption per population in service area. This ratio was assumed to be similar to the detailed case studies presented in the following section. (Estimate: 2,450 gpm per 10,000 people, continuous throughout the year)
- Combined turbine/generator system efficiency is 85 percent.

Determination of the Statewide PRV Hydropower Potential

Based on the assumptions listed above and using the professional judgement of the team, we have estimated that there is conservatively 20 to 25 MW of hydropower potential in replacing PRVs statewide.

- Total power for 65 psi, 2,450 gpm, and 85 percent efficiency is 28 kW.
- Total annual energy for 59 kW continuous is 516,840 kWh.
- Similar conditions exist for 63 percent of the 5.5 million state inhabitants, or 3.5 million
- Projection of 59 kW per 10,000 people to 3.5 million = 20.6 MW
- Annual energy with continuous operation statewide = 176 GWh

5 | Detailed Case Studies

Water providers that supplied information by April 27, 2016 were in the running to be selected for additional development assistance. Selection of the two water providers were guided by the following criteria:

- 1) Input complete information for PRVs into the geoportal prior to the deadline.
- 2) The selected water providers were geographically diverse.
- 3) The selected water providers represented diverse population sizes.
- 4) The selected water providers represented diverse economic locations.
- 5) The selected water providers were similar to other water providers so lessons learned could be easily transferable.

The City of Montrose and North Table Mountain Water and Sanitation District were selected for the detailed case studies.

North Table Mountain Water and Sanitation District

This detailed case study summarizes the results of an initial review of the raw water delivery system for the North Table Mountain Water and Sanitation District, in Golden, CO. The purpose was to assess the potential of replacing one or more of the pressure reducing valves with hydroelectric power generating equipment.

The general operation of the plant (yearly), the local substation and electrical distribution system were also reviewed - including an emergency standby generator.

The raw water for the treatment plant is delivered from Ralston Reservoir via two (2) steel pipes with approximately 85 psi (196') static head and 75 psi (173') dynamic head. One is an 18-inch pipe, the other is a 24-inch pipe and each can deliver 1,000 gpm to 4,000 gpm on an "as needed" basis. They are terminated in the pipe gallery with two parallel pressure reducing valves. These pressure reducing valves reduce pressure to a level suitable for treatment plant operation.

Based on this preliminary review, it appears that retrofitting either of the pressure reducing valves with hydropower equipment could provide as much as 80 kW of power, depending on the available flow rate.

Annual energy production is based on day-to-day operating procedures. Assuming 2,000 gpm as an average flow rate,

annual energy production would be about 375,000 kWh. Based on preliminary estimates of project costs at \$170,000 this could indicate a simple payback of 11 years.

The project appears to be a favorable candidate for an exemption from FERC licensing. Also, since the operational needs of the plant exceed the electrical energy available from a retrofitted PRV, net metering would be the preferred method for power marketing.

Finally, a review of "standard operating procedures" is suggested to see if there are opportunities available for reducing peak loads in the plant - and thus lower monthly electrical energy charges. This detailed case study is a first step but additional information will be necessary to verify several assumptions if North Table Mountain Water and Sanitation District chooses to proceed with the project.

City of Montrose

A detailed case study was conducted on a pressure reducing valve within the City of Montrose water supply system to assess the possibility of installing a turbine/generator unit in place of the PRV to generate power. The pressure reducing valve located on Niagara Road was selected for the detailed case study due to its proximity to a city-owned facility, the Montrose Pavilion Event Center. When a turbine generator unit is installed at this location, water will be directed through the Niagara PRV-hydropower unit to generate electricity. Excessive water above the capacity of the turbine and low flow below the shut-off flow of the turbine will be directed to other pressure reducing valves.

A 24 kW "pump as turbine" unit was selected and the annual energy output was estimated to be 139,880 kWhs. The City of Montrose is currently paying \$0.10/kWhs at the Montrose Pavilion Event Center, which uses approximately 472,000 kWhs annually. Therefore, the City of Montrose can potentially save approximately \$14,000 annually and the electricity generated can be net metered at the Center. The total cost of installing the hydroelectric equipment at this location is estimated to be \$120,000. The benefit/cost ratio is 1.1 with a payback period of 11 years. This case study appears promising for the installation of a small turbine/generator unit at the Niagara PRV. The project appears to be a favorable candidate for an exemption from FERC licensing. This detailed case study is a first step, but additional information will be necessary to verify several assumptions if the city chooses to proceed with the project.



6 | Potential Barriers to Development

A reasonable question to the amount of potential for hydropower by replacing PRVs is: “Why have these sites not been developed?” Historically, the amount of federal regulations for developing small hydropower was excessive and stifled all but the most profitable projects. New regulations, which resulted from an initial Memorandum of Understanding (MOU) between Colorado and FERC, exempt certain low impact projects from FERC oversight and has opened the door for new development. However, even with the reduction of the FERC regulatory burden, some barriers remain.

At present, hiring a consultant for initial investigation, feasibility studies, and design costs can represent significant costs for small projects. Also, the wide range of turbines and small number of projects under 100 kW has led to a lack of

off-the-shelf water to wire equipment, making each project a one-of-a-kind expenditure. Importantly, power utility companies are trying to find how to best incorporate these types of projects into their portfolios. As a result, there are wide swings in the power purchase agreements between utility providers. For some utilities, the power purchase agreement is case-by-case and requires the developer to retain legal counsel, making small hydropower projects more costly. Some utilities allow for net metering, which essentially allows for a retail rate for the energy produced. These situations can be favorable for the development of PRV to hydropower, depending on the rates.



7 | Next Steps and Potential Solutions to Barriers

The projected potential of PRV to hydropower within the state and the detailed case studies point to a positive future for the development of this renewable energy source within the state of Colorado. While barriers do exist, they can be overcome with directed programs, additional funding and an influx of similar projects.

These proposals may include: 1) a statewide “feed-in” tariff for small hydro, 2) the option of “aggregating” small hydro projects for renewable energy marketing, 3) the availability of additional grants and low interest loans for small hydro development, 4) importing for domestic production selected types of turbine/generator packages, and 5) legislation mandating small hydro development as part of new water resource development and refurbishment.

Further Development of the PRV Inventory and the Geoportal

The geoportal was developed with the idea that it represents the first phase in development. It accomplished the goal of identifying the water providers within the state and providing a mechanism for the water providers to confirm distribution boundaries and enter basic information about their PRVs into a GIS database. In return, the information input allowed for a simple nominal capacity calculation to be determined for each PRV. In the future, the geoportal can be configured to allow respondents to be prompted to input more detailed information in modules. These modules could be configured to allow for the calculation of the energy that could be produced, provide preliminary cost estimates and determine preliminary project payback timing. Essentially the geoportal could allow water providers the opportunity to get information on a preliminary feasibility without having to spend money on consultants until the project looks favorable with this first cut.

Availability of Funding for Detailed Case Studies

CEO utilized the results of prior initiatives (MOU with FERC for streamlined permitting, permitting pilot project, and the Renewable Energy Development Team with its detailed case studies) to pave the way for producing a comprehensive Small Hydropower Handbook. These initiatives more importantly spurred the development of many small hydropower projects that are now on-line and producing power. Similarly, future initiatives from CEO could be used to spur development of PRV hydropower. As this development grows, consulting will become more specialized and streamlined and equipment will become more available for standard installations.

Attachment 1

COLORADO ENERGY OFFICE CEO DQ1 EFAA 2016-0843
COLORADO PRV-HYDROPOWER ASSESSMENT
(Detailed Case Study 1)
North Table Mountain Water and Sanitation District
Golden, Colorado

Prepared by:
Amec Foster Wheeler Environment & Infrastructure, Inc.
2000 S. Colorado Blvd.
Suite 2 - 1000
Denver, CO 80222

Advanced Energy Systems, LLC
1428 S. Humboldt St.
Denver, CO 80210

Community Hydropower Consulting, LLC
P.O. Box 1091
Fort Collins, CO 80522

June 2016
Project No. 32820067

Table of Contents

- EXECUTIVE SUMMARY..... 20**
- 1.0 INTRODUCTION 21**
 - 1.1 Location.....21
 - 1.2 Background21
- 2.0 HYDRAULIC CHARACTERISTICS..... 22**
 - 2.1 Water Pressure22
 - 2.2 Water Flow.....22
- 3.0 POWER ANALYSIS 22**
 - 3.1 Energy production - kWh.....23
- 4.0 TURBINE AND EQUIPMENT SELECTION 23**
- 5.0 PROJECT COST ESTIMATE 24**
- 6.0 POWER PURCHASE OPTIONS 24**
- 7.0 ECONOMIC ANALYSIS..... 24**
- 8.0 RECOMMENDATIONS / NEXT STEPS..... 24**

Figures

- Figure 1: PRV Vault (foreground) and Water Treatment Plant.....21
- Figure 2: Pressure Reducing Valve.....21
- Figure 4: Static Pressure - PRV Vault.....22
- Figure 3: Ralston Reservoir22
- Figure 5: Reverse Pump Turbine/Generator.....23
- Figure 6: Toshiba Hydro-eKids Turbine/Generator23
- Figure 7: Utility Transformer Bank24
- Figure 8: Power Distribution Center.....24

EXECUTIVE SUMMARY

This detailed case study summarizes the results of an initial review of the raw water delivery system for the North Table Mountain Water and Sanitation District, in Golden, Colorado. The purpose was to assess the potential of replacing one or more of the pressure reducing valves with hydroelectric power generating equipment.

The general operation of the plant (yearly), the local substation and electrical distribution system were also reviewed - including an emergency standby generator.

The raw water for the treatment plant is delivered from Ralston Reservoir via two (2) steel pipes with approximately 85 psi (196') static head and 75 psi (173') dynamic head. One is an 18-inch pipe, the other is a 24-inch pipe and each can deliver 1,000 gpm to 4,000 gpm on an "as needed" basis. They are terminated in the pipe gallery with two parallel pressure reducing valves. These pressure reducing valves reduce pressure to a level suitable for treatment plant operation.

Based on this preliminary review, it appears that retrofitting either of the pressure reducing valves with hydro-power equipment could provide as much as 80 kW of power, depending on the available flow rate.

Annual energy production is based on day-to-day operating procedures. Assuming 2,000 gpm as an average flow rate, annual energy production would be about 375,000 kWh. Based on preliminary estimates of project costs at \$170,000 this could indicate a simple payback of 11 years.

The project appears to be a favorable candidate for an exemption from FERC licensing. Since the operational needs of the plant exceed the electrical energy available from a retrofitted PRV, net metering would be the preferred method for power marketing.

Finally, a review of "standard operating procedures" is suggested to see if there are opportunities available for reducing peak loads in the plant and thus lower monthly electrical energy charges. This detailed case study is a first step and additional information will be necessary to verify several assumptions if North Table Mountain Water and Sanitation District chooses to proceed with the project.

1.0 INTRODUCTION

The Colorado Energy Office (CEO) launched the Colorado PRV-Hydropower Assessment Initiative aimed at identifying and promoting new small and micro hydropower projects in Colorado. The Amec Foster Wheeler Team (Team), comprised of Amec Foster Wheeler Earth and Environment, Advanced Energy Systems, and Community Hydropower Consulting, was retained by CEO as a contractor to aid in selecting and conducting detailed case studies that will be included in the Colorado PRV-Hydropower Assessment. The North Table Mountain Water and Sanitation District (NTM) submitted complete information into the interactive Geoportal tool developed by Amec Foster Wheeler as a part of the contract and was used to develop an inventory of potential PRV-Hydropower opportunities in Colorado. The NTM was selected as one of the two detailed case studies. This report provides the findings of the detailed case study on a PRV at the NTM water treatment facility.

1.1 Location

The North Table Mountain Water and Sanitation District is located in Golden, CO. The NTM service area is near the western edge of the Denver metro area, just north of North Table Mountain. Domestic water and sanitation services are provided to 10,000 residents, businesses and industries.

1.2 Background

This detailed case study covers initial findings and analyses by Richard Smart of Community Hydropower Consulting and Tim Olsen of Advanced Energy Systems, with input and review from Brad Florentin and Joe Zhao of Amec Foster Wheeler. During a site visit to the NTM in Golden, Colorado on Friday, May 6, 2016, they met with officials of NTM including: Bart Sperry, Wendy Weiman and Grant Berry. This meeting began with an office review of the NTM service area, major features of the system and a brief history of the district.

This office meeting was followed by a site visit to the water treatment plant (Figure 1), that included a pipe gallery, two pressure reducing valves (PRVs) (Figure 2), water treatment room, and supporting facilities and electrical systems.



FIGURE 1: PRV VAULT (FOREGROUND) AND WATER TREATMENT PLANT



FIGURE 2: PRESSURE REDUCING VALVE

The objective of the detailed case study is to assess the potential for retrofitting one or more of the PRVs with hydropower generating equipment.

The NTM district is a quasi-governmental agency formed in 1958, and the current water treatment plant was built in 1997. The plant is located at the northwest corner of the service area, at elevation 5,850 feet.

Raw water is delivered to the treatment plant from Ralston Reservoir (Figure 3) through two parallel steel pipes – an 18-inch pipe and a 24-inch pipe. Each pipe is approximately 4,900 feet long. These pipes feed two PRVs before en-

tering the water treatment plant. The PRVs and valving are contained in a separate vault. Operationally, the plant uses only one PRV a time.

2.0 HYDRAULIC CHARACTERISTICS

2.1 Water Pressure

The elevation of the treatment plant is 5,850 feet. The static head of the raw water is 85 psi (Figure 4). The dynamic pressure typically is about 75 pounds per square inch (psi). The dynamic "down-stream" pressure is 10 psi.

The smaller of the two steel pipes (18-inch diameter) has ample size for the flow and distance, providing a low water speed of 2.5 feet per second (fps) at 2000 gallons per minute (gpm), to minimize dynamic head losses through friction and flow distortions at the fittings. Of course, the speeds are even lower in the 24-inch pipe, and the speed doubles at 4000 gpm to an acceptable 5.0 fps. The piping appears to be in good condition, although internal inspections were not made. The only improvements considered are to install Y-joints above and below the PRVs in the event two PRVs are desired with the hydro turbine.



FIGURE 3: RALSTON RESERVOIR



FIGURE 4: STATIC PRESSURE - PRV VAULT

Power or net head is the head available for power production and is the static head less friction and local losses in the penstock between the intake and the tailrace. For the case of PRVs, power head is the difference between dynamic head upstream and downstream of the device, as it may be required to deliver a certain head to downstream facilities.

Power or net head is the head available for power production and is the static head less friction and local losses in the penstock between the intake and the tailrace. For the case of PRVs, power head is the difference between dynamic head upstream and downstream of the device, as it may be required to deliver a certain head to downstream facilities.

During operation at NTM the dynamic head upstream of the PRVs is approximately 75 psi (173 feet). The PRVs remove 65 psi (150 feet), passing downstream pressure of 10 psi (23 feet). Operationally, the plant uses only one PRV at a time.

2.2 Water Flow

The water flows are not delivered continuously and have significant daily and seasonal variation. Flow data was conveyed verbally from the operations staff: they typically run at 2000 gpm for eight to 10 hours per day during the winter, and 18 hours per day during the summer. That means the flow is shut down several hours per day, but it also runs up to 4000 gpm at times. Based on the flow information conveyed above, The NTM staff estimate 2,000 gpm is a realistic yearly average flow.

3.0 POWER ANALYSIS

The nominal installed capacity would be based on the type of turbine/generator selected. Some turbines have rather narrow efficiency ranges, whereas others have wider ranges - with reasonable efficiencies available from less than 50 percent to 80 percent overall.

Based on the head and flow information, a range of 21 kW to 85 kW of power could be available from a hydro-power turbine-generator. The estimated average annual flow of 2,000 gpm would provide 48 kW shaft power and 43 kW electrical, assuming an 84 percent efficient turbine and 92 percent efficient electrical system.

3.1 Energy production - kWh

With full-year operation less one week down time, annual energy production would be about 375,000 kWh.

Based on preliminary estimates of project costs and energy savings value, this could offer a simple payback of 11 years.

4.0 TURBINE AND EQUIPMENT SELECTION

There are two general classifications of hydraulic turbines, impulse and reaction. Impulse turbines such as Pelton and Turgo are generally for high head and low-to-medium flow applications. They typically vent to atmosphere, and thus are not appropriate for PRV replacement if downstream pressure is required. Reaction turbines include Francis, Kaplan, propeller, and "reverse-pump," which generally operate under medium-to-low power head and a wide range of flow conditions.

If the plant could operate year-round at near 2,000 gpm a "reverse-pump" or "pump as turbine" type turbine (Figure 5) may be the most cost effective. These turbines have a narrow efficiency flow range that is based on available pressure. The system controls would modulate the adjacent PRV for additional flows as needed for treatment plant operation.

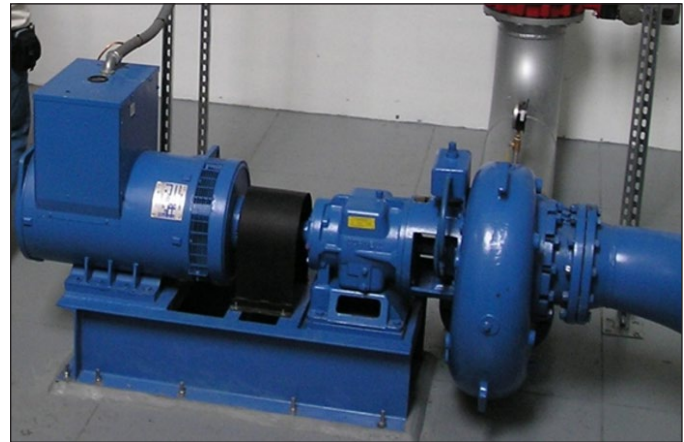

FIGURE 5: REVERSE PUMP TURBINE/GENERATOR

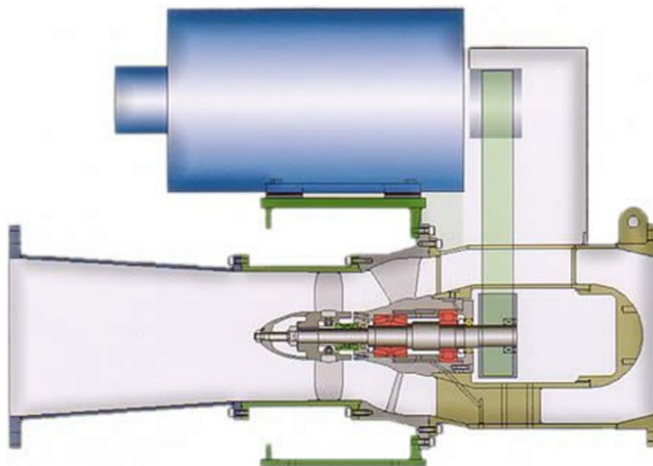

FIGURE 6: TOSHIBA HYDRO-EKIDS TURBINE/GENERATOR

Kaplan, propeller (Figure 6), and Francis turbines all have a wider range of efficient flows. However, they are more expensive and require significant modifications to the piping.

Pelton turbines also have a wide efficiency range, but they require reconfiguring the plant discharge to atmosphere at the turbine, then add pump power for flows needed to the treatment plant.

Two turbine suppliers were examined more closely for this project. Toshiba Hydro offers a series of micro-to-medium propeller turbines ("e-Kids") that are well-suited for conduit flow. The most common applications for Toshiba's products are at PRV locations

already in water systems. These turbines handle low-to-medium pressures and can be cascaded in series for high-head conditions. Cornell Pump Company carries a wide-range of micro-to-medium reverse-pump turbines that are well-suited for conduit flow. Similar to the Toshiba e-Kids, Cornell pumps are available for low-to-medium flows, but prefer a narrow operating range for each model. These units require relatively little space, and thus make good candidates for PRV replacement in tight vaults.

A detailed engineering analysis beyond the scope of this report is required for a final selection of the most appropriate turbine option. This study assumes a reverse-pump turbine with induction generator going forward.

5.0 PROJECT COST ESTIMATE

The following preliminary estimate is based on a reverse-pump type turbine coupled to an induction generator and relies on experience from similar projects.

Engineering	\$ 20,000
Turbine and generator	\$ 60,000
Control and electrical system	\$ 40,000
Additional valves and piping	\$ 15,000
Installation	\$ 25,000
Contingency	\$ 10,000
Total: (preliminary estimate)	\$160,000

6.0 POWER PURCHASE OPTIONS

Xcel energy is the electric power provider with 480 Volt, three-phase power (Figures 7 and 8). The monthly electric bill is reported to be around \$8,000. This would include both a demand charge and energy use. A typical bill is not available as of this writing. However, detailed analysis of the electrical rate structure and options for power purchase agreements or net metering are suggested as next steps. In addition, an analysis of plant operations is recommended to determine if peak loads could be reduced by modifying plant procedures. In the meantime, we expect the plant to be on a commercial demand tariff, in which the energy price hovers around \$0.04/kWh. The hydropower system would offset energy costs at that rate. It could possibly reduce peak demands as well, but we can't guarantee that without much more complex interaction with plant operations.

7.0 ECONOMIC ANALYSIS

Assuming an annual energy production of 375,000 kWh and utility energy billing rate of \$0.04/kWh an annual savings of \$15,000 is expected. Based on preliminary estimates of project costs at \$170,000 plus minimal O&M costs, this would indicate a simple payback of 11 years.

8.0 RECOMMENDATIONS / NEXT STEPS

Hydropower has relatively high up-front capital costs compared to other types of renewable energy resources such as wind and solar. However, once these capital costs are retired, hydropower provides an inflation-proof, inexpensive source of power. While incurring low operational and maintenance costs, hydro facilities typically have an expected service life of 50 to 80 years and thus represent a long-term investment.

There appear to be several sources for financing, including possible grants and low-interest loans to support small hydro development.

Based on these preliminary results, it is suggested that a full engineering study be developed to outline 1) technical options for development, 2) financing opportunities, and 3) possible supporting grants. If the district should decide to move forward, it is suggested that a multi-discipline project team be formed to manage and oversee the project.



FIGURE 7: UTILITY TRANSFORMER BANK



FIGURE 8: POWER DISTRIBUTION CENTER

Attachment 2

COLORADO ENERGY OFFICE CEO DQ1 EFAA 2016-0843
COLORADO PRV-HYDROPOWER ASSESSMENT
(Detailed Case Study 2)
City of Montrose
Montrose, CO



Prepared by:
Amec Foster Wheeler Environment & Infrastructure, Inc.
2000 S. Colorado Blvd.
Suite 2 - 1000
Denver, CO 80222

Advanced Energy Systems, LLC
1428 S. Humboldt St.
Denver, CO 80210

Community Hydropower Consulting, LLC
P.O. Box 1091
Fort Collins, CO 80522

June 2016
Project No. 32820067

Table of Contents

EXECUTIVE SUMMARY	27
1.0 INTRODUCTION	28
1.1 Location.....	28
1.2 Background	28
2.0 HYDRAULIC CHARACTERISTICS	29
2.1 Water Pressure	30
2.2 Water Flow.....	31
3.0 POWER ANALYSIS	32
3.1 Hydroelectric Parameters	32
3.2 Energy Production - kWh.....	32
4.0 HYDRAULIC TURBINE TYPE AND SIZE SELECTION	33
5.0 PROJECT COST ESTIMATE	34
6.0 POWER PURCHASE OPTIONS	34
7.0 ECONOMIC ANALYSIS	34
7.1 Proposed Financial Plan and Cash Flow.....	34
8.0 RECOMMENDATIONS / NEXT STEPS	35

Figures

Figure 1: Location of City of Montrose	28
Figure 2: Niagara PRV Location	29
Figure 3: Conceptual Block Flow Diagram.....	30
Figure 4: Flows to Niagara PRV.....	31
Figure 5: Flow Duration Curve	32
Figure 6: Flow Allocation Curve.....	33

EXECUTIVE SUMMARY

As a part of the PRV-Hydropower Assessment contract between the Colorado Energy Office (CEO) and Amec Foster Wheeler Environment and Infrastructure, Inc. (PO EFAA2016-0843), a detailed case study was conducted on a pressure reducing valve within the City of Montrose water supply system to assess the possibility of installing a turbine/generator unit in place of the PRV to generate power. The pressure reducing valve located on Niagara Road was selected for the detailed case study due to its proximity to a city-owned facility, the Montrose Pavilion Event Center. When a turbine generator unit is installed at this location, water will be directed through the Niagara PRV-hydropower unit to generate electricity. Excessive water above the capacity of the turbine and low flow below the shut-off flow of the turbine will be directed to other pressure reducing valves. A 24 kW “pump as turbine” unit was selected and the annual energy output was estimated to be 139,880 kWhs. The City of Montrose is currently paying \$0.10/kWhs at the Montrose Pavilion Event Center, which uses approximately 472,000 kWhs annually. Therefore, the City of Montrose can potentially save approximately \$14,000 annually and the electricity generated can be net metered at the Center. The total cost of installing the hydroelectric equipment at this location is estimated to be \$120,000. The benefit/cost ratio is 1.1 with a pay-back period of 11 years. This case study appears promising for the installation of a small turbine/generator unit at the Niagara PRV. The project appears to be a favorable candidate for an exemption from FERC licensing. This detailed case study is a first step and additional information will be necessary to verify several assumptions if the city chooses to proceed with the project.

1.0 INTRODUCTION

The Colorado Energy Office (CEO) launched the Colorado PRV-Hydropower Assessment Initiative aimed at identifying and promoting new small and micro hydropower projects in Colorado. The Amec Foster Wheeler Team (Team), comprised of Amec Foster Wheeler Earth and Environment, Advanced Energy Systems, and Community Hydropower Consulting, was retained by CEO as a contractor to aid in selecting and conducting detailed case studies that will be included in the Colorado PRV-Hydropower Assessment. The City of Montrose submitted complete information into the interactive Geoportal tool developed by Amec Foster Wheeler as a part of the contract and used to develop an inventory of potential PRV-Hydropower opportunities in Colorado. The city was selected as one of the two detailed case studies. This report provides the findings of the detailed case study on a PRV in the City Water Supply System.

1.1 Location

The City of Montrose is located on the Western Slope of Colorado along U.S. Highway 50. It is the county seat and the most populous municipality of Montrose County. The city population is about 20,000, as estimated by the 2010 United States Census and has a total area of about 12 square miles. Figure 1 shows the location of the city within the state of Colorado.



FIGURE 1: LOCATION OF CITY OF MONTROSE

1.2 Background

This detailed case study covers initial findings and analyses by Brad Florentin and Joe Zhao of Amec Foster Wheeler, with input and review from Richard Smart of Community Hydropower Consulting and Tim Olsen of Advanced Energy Systems. During a site visit to the city on Tuesday, May 10, 2016, they met with The Utility Division Superintendent, David Bries. This meeting began with an office review of the city service area, major features of the system and a brief history.

This office meeting was followed by a site visit to several of the pressure reducing valves (PRVs) within the distribution system. The objective of the detailed case study is to assess the potential for retrofitting one or more of the PRVs with hydropower generating equipment.

The city gets its potable water from the Project 7 Water Authority. Potable water was provided to the municipalities and rural areas of the Uncompahgre River Valley through a cooperative effort among seven area water entities including the city. The majority of water supplied to Project 7 for treatment comes from the Blue Mesa Reservoir via the Crystal Reservoir. A small amount (<5 percent) comes from Silverjack Reservoir via Cerro Reservoir. After treatment, the potable water enters the city limits from the east in a pipeline along Highway 50. The city's distribution system consists of two pressure zones - an upper pressure zone and a lower pressure zone. According to the city, water can be directed to any number of the seven existing PRVs that separate the two zones. Of the seven PRVs, five were initially selected as candidates for investigation of being fitted with hydropower based on the operation of the system by the Utility Division Superintendent, David Bries. On May 10, 2016, Mr. Bries and engineers from Amec Foster Wheeler investigated the PRVs on Highway 50, Miami Road, Sunnyside Road, Niagara Road and Oak Grove Road. The 8-inch diameter PRV located between the two pressure zones on Niagara Road (named Niagara PRV) was selected for one of the two detailed case studies due to its proximity to a city-owned facility, the Montrose Pavilion Event Center, and from preference in system operation. Figure 2 shows the location of the Niagara PRV in relation to the city.

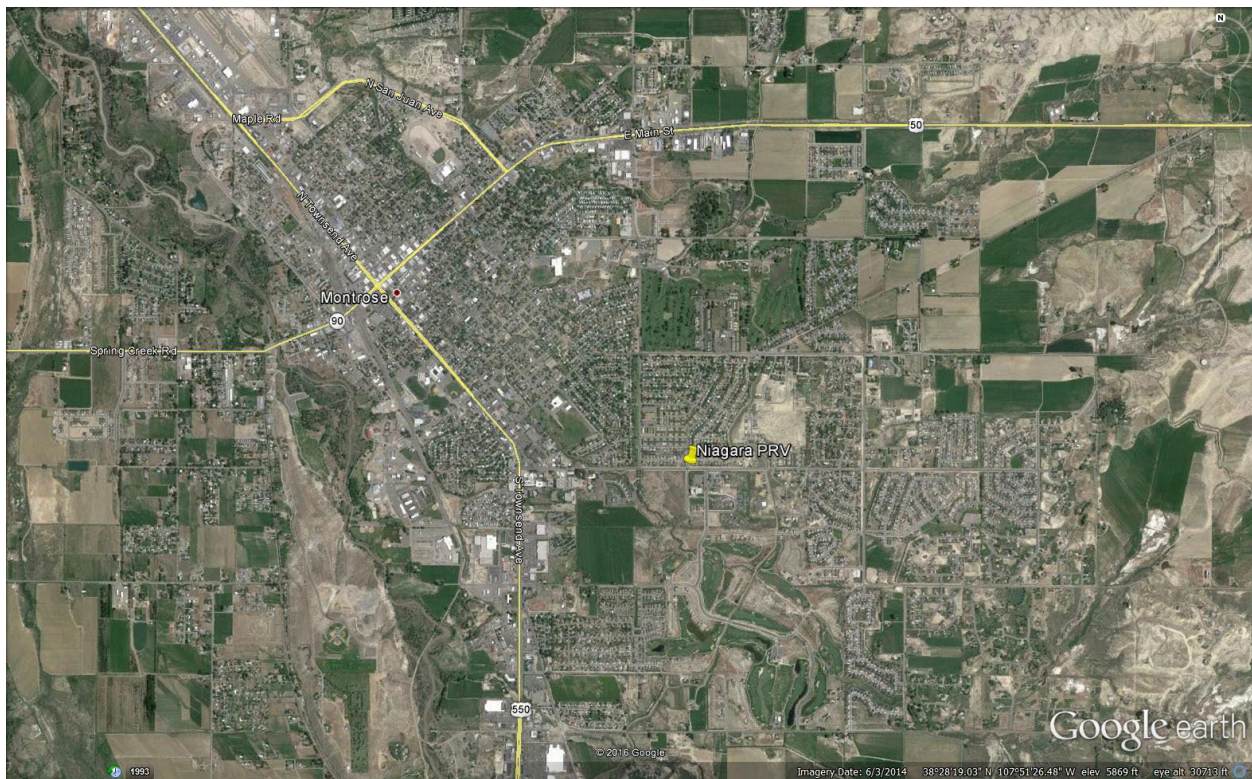

FIGURE 2: NIAGARA PRV LOCATION

2.0 HYDRAULIC CHARACTERISTICS

There are several assumptions used in the analysis of the data and determination of the flows and pressure heads available for power generation. These assumptions are listed below:

- Winter is defined as October 15 to April 15.
- 300 gallons per minute (gpm) flow to a tank in the upper pressure zone in the winter and are not available for electricity production.
- 60 percent of the water after the 300 gpm is diverted to the tank in winter passes the PRVs to the lower pressure zone through the PRVs.

- The system can be operated such that, if needed, all water can be passed through one of the PRVs. For the purpose of this project, it is assumed that all water available will pass through Niagara PRV. This also allows for the other PRVs to operate if the Niagara hydro system is off, thereby eliminating the need for a bypass system at this location.
- Niagara PRV has a maximum flow capacity of 1,250 gpm.
- The upper pressure zone has a constant pressure throughout the year of 110 pounds per square inch (psi). The lower pressure zone has a constant pressure throughout the year of 56 psi. Operational pressures between the upper and lower pressure zones are relatively constant and therefore assumed to be constant. The difference in pressure between the upper and lower zones is assumed to be 54 psi.
- The Niagara PRV is eight inches in diameter.
- The city has the appropriate water rights.

A conceptual block flow diagram describing the flow assumptions is provided in Figure 3.

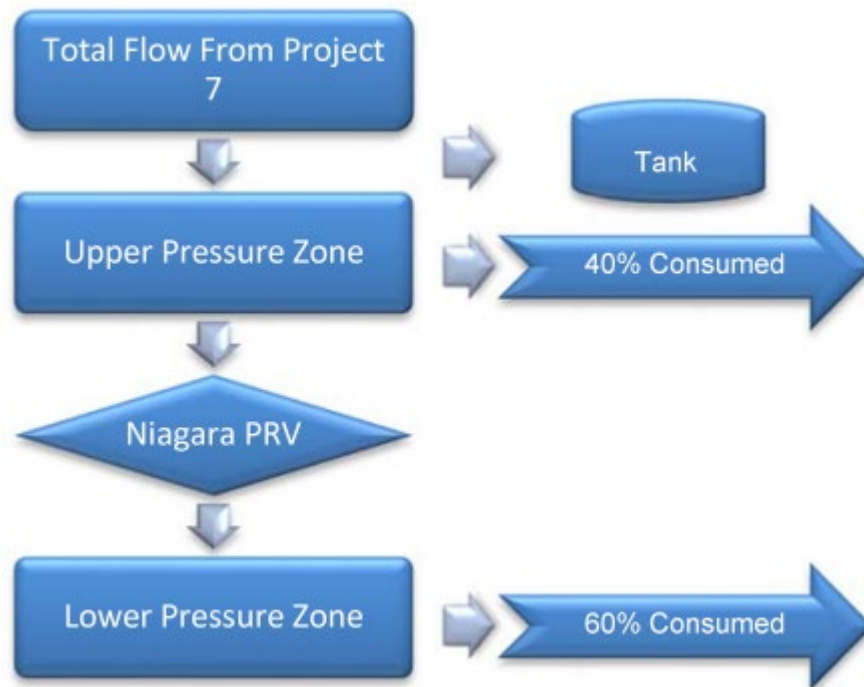

FIGURE 3: CONCEPTUAL BLOCK FLOW DIAGRAM

2.1 Water Pressure

Power or net head is the head (or pressure) available for power production and is the static head less friction and local losses in the penstock between the intake and the outlet for a turbine. For this detailed case study, it is assumed that the power head is the pressure difference across the PRV. As stated in the assumptions, the difference in pressure between the upper and lower zones is assumed to be 54 psi or 125 feet (ft).

2.2 Water Flow

Water flow through a turbine is one of the two principal parameters for generating hydropower. The other one is hydraulic head (water pressure). This section will quantify the water supply available for hydropower production at Niagara PRV and develop design criteria for the turbine hydraulic rating.

2.2.1 Collected Flow Data

Total monthly water volume purchases for the Montrose City Water Supply System from Project 7 were provided from January 2008 through March 2016. The monthly water volumes were assumed to be spread evenly throughout the month to determine the average flow in gallons per minute for the month. A flow of 300 gpm to the tank in the upper pressure zone was subtracted from the total flow during the winter season and no flow to the tank was subtracted during the summer season. The upper pressure zone is assumed to consume 40 percent of the remaining flow, leaving 60 percent of the flow to be routed through the seven existing PRVs. During the winter, most or all of the flow can be routed to Niagara PRV.

The flow assumed to continue to the lower pressure zone was computed from the monthly flow rates and converted to cubic feet per second (cfs). These are the flow available for electricity generation as shown in Figure 4.

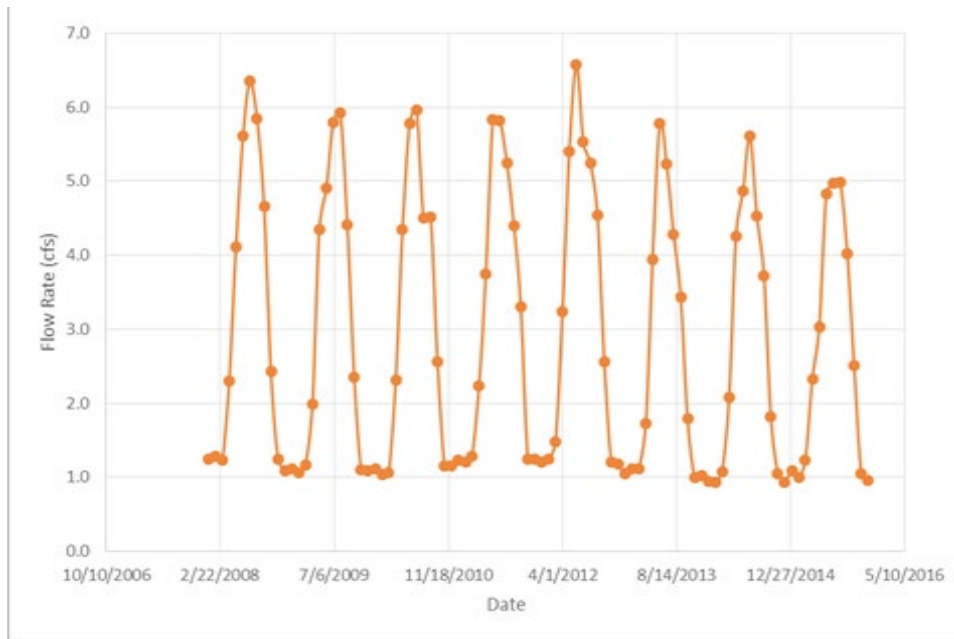

FIGURE 4: FLOWS TO NIAGARA PRV

2.2.2 Flow Duration Curve

The available flow rates to Niagara PRV were analyzed with the help of a flow-duration curve calculated from the data. The flow-duration curve using all eight years of flow data is shown in Figure 5.

**Figure 5. Flow Duration Curve
Niagara PRV (2008 to 2015)**

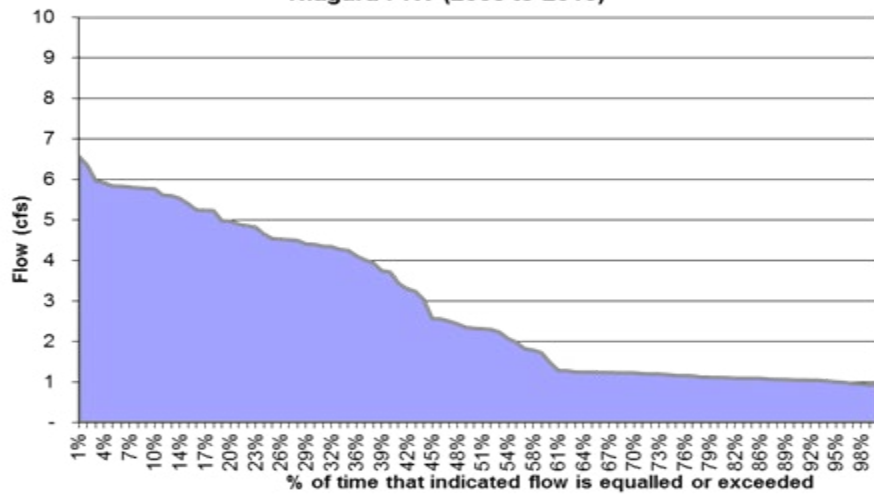

FIGURE 5: FLOW DURATION CURVE

The flow duration curve describes the percentage of time different amounts of flow are equalled or exceeded. For example, the flow-duration curve shows that 50 percent of the flow rates during the eight years are greater than 2.3 cfs. This curve is used to establish the hydroelectric plant size by selecting the plant’s hydraulic capacity (the maximum discharge that could be passed through the turbine). The flow duration curve shows that the flow range that can be expected at the power intake is between 0.9 cfs to 6.6 cfs.

3.0 POWER ANALYSIS

3.1 Hydroelectric Parameters

The following parameters were selected and a total turbine and generator efficiency of 90 percent was assumed for the selected turbine/generator unit.

- Rate Discharge = 2.5 cfs
- Rated Head = 125 ft
- Shut-off Flow Rate = 1.0 cfs
- Overall Plant Efficiency = 90 percent
- Installed Capacity = 24 kW

3.2 Energy Production - kWh

The flow-duration curve shown in Figure 5, the associated maximum hydraulic capacity and the minimum shut-off flow rate are used to calculate the energy output. The area below the flow-duration curve limited by the maximum hydraulic capacity of 2.5 cfs and the shut-off flow rate of 1.0 cfs is the amount of energy production. The area between the flow-duration curve and the maximum hydraulic capacity of 2.5 is the energy “wasted” due to overflow and the area below the shut off flow rate is the energy that cannot be generated because the turbine is shut-off due to the severe cavitation of turbine and low efficiency. A generator efficiency of 94 percent was assumed for the calculation. The following annual energy production and plant factor was obtained:

- The average total energy production per year = 145,475 kWhs
- The net average total energy production after two weeks maintenance per year = 139,880 kWhs
- The annual plant factor = 69 percent.

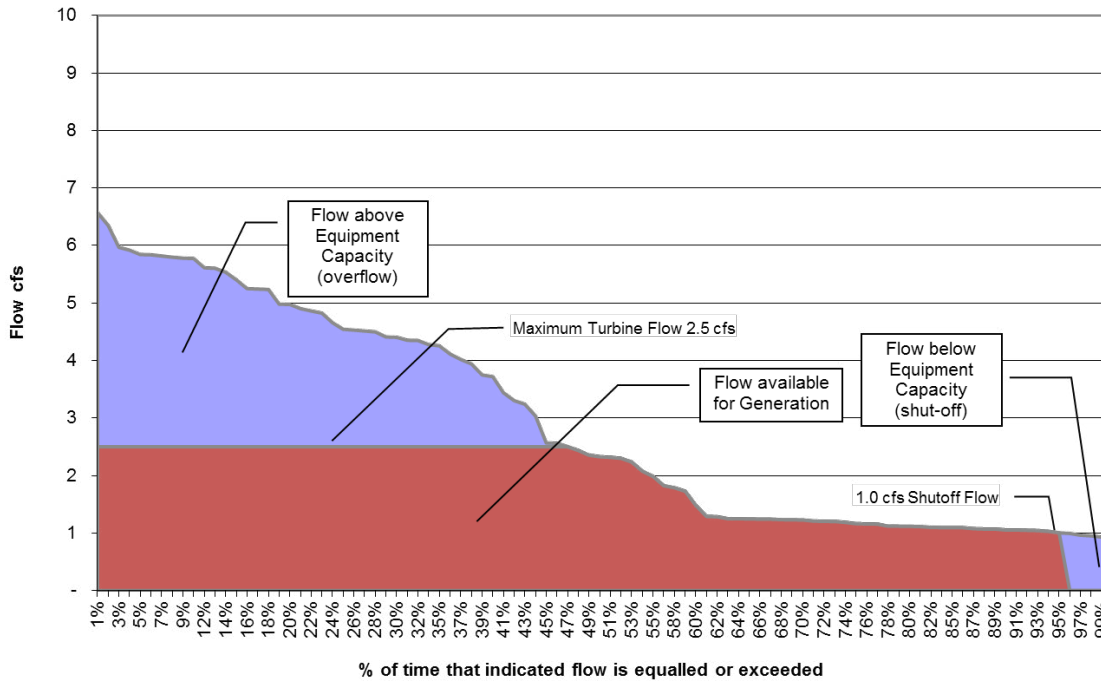

FIGURE 6: FLOW ALLOCATION CURVE

The annual plant factor is the ratio of the average load on a plant for a year to its installed rated capacity. Small hydroelectric installations typically optimize in the 40- and 60-percent factor range. The annual plant factor of 69 percent appears to be reasonable for this installation.

4.0 HYDRAULIC TURBINE TYPE AND SIZE SELECTION

There are two general classifications of hydraulic turbines, impulse and reaction. Impulse turbines, such as the Pelton type are generally for high power head and low flow applications. Reaction turbines, such as the Francis and Kaplan types generally operate under medium-to-low-power head and medium-to-high-flow conditions, respectively.

The power head range for this project was classified as low-to-medium, for which Francis, Kaplan and fixed-blade propeller type units are suitable. Additionally, because a pressure of 56 psi is required downstream of the turbine, it is not realistic to use a Pelton type of turbine as it discharges to atmosphere. Therefore, a reaction turbine such as Francis and Kaplan is required. A turbine manufacturer or supplier was consulted to select the most economic and efficient turbine/generator unit. For the purpose of this case study, a "reverse pump" or "pump as turbine" is selected as the turbine due to its small size. A stand-alone system is likely the most economic choice.

The flow-duration curve shows that the flow range that can be expected at the power intake is from 0.9 cubic feet per second (cfs) to 6.6 cfs. Because the flow-duration curve does not have a clear "break point," other criteria may be used for turbine sizing. A comprehensive economic study is typically required for comparing various alternatives such as different sizes of unit or multiple units. For this detailed case study, the city intends to supply electricity to the nearby Montrose Pavilion Event Center year-round. Therefore, the turbine should be sized considering winter flows as well as summer flows. The maximum turbine capacity is selected to be

2.5 cfs. With this maximum hydraulic turbine capacity the turbine can still run at a flow of 40 percent of the maximum hydraulic capacity or 1.0 cfs. At 40 percent of the maximum hydraulic capacity the “reverse pump” will run at a low efficiency. Figure 6 shows the flow allocation curve and the associated maximum hydraulic capacity and the minimum shut-off flow rates. Flows in the range between 1.0 cfs and 2.5 cfs will normally go through the proposed turbine for generation. Flows above the maximum hydraulic capacity of the turbine of 2.5 cfs and below the shut-off flow rate 1.0 cfs will be directed through the other PRVs without generation.

5.0 PROJECT COST ESTIMATE

A preliminary opinion of probable cost for the selected alternative was prepared for this detailed case study. The cost estimate of equipment from a domestic hydroelectric equipment manufacturer is \$55,000 to \$65,000. The equipment includes turbine, generator, electronic load control governor, frequency guard relay, turbine inlet valve with hydraulic actuator, hydraulic power unit, direct drive coupling with guard, inlet and outlet transition cones and structural steel equipment mounting frame. The cost estimate of the remaining items, engineering and 20 percent contingency was estimated to be \$120,000 based on experience on other similar hydroelectric projects.

6.0 POWER PURCHASE OPTIONS

The city intends to use the energy generated at this PRV-Hydropower facility to supply electricity to the nearby city-owned Montrose Pavilion Event Center. This allows for potential of a net metering agreement. In effect, the city would be getting retail rates for the energy produced. The Center is currently paying \$0.10/kWh based on the city’s bill for service at the Pavilion from March 25 to April 25, 2016. This rate was used in the economic analysis and it was further conservatively assumed that the same rate of \$0.10/kWh remains the same during the 50-year planning period. If the rate increases with the time the PRV-Hydropower project will become more feasible. During this one month, the Pavilion used 39,360 kWhs and the average annual usage at the Pavilion is approximately 472,000 kWhs, which is greater than the total anticipated annual electricity generation of 139,880 kWhs by the proposed PRV-Hydropower project. Therefore, all electricity generated by the facility can be used at the Pavilions and interconnection with utility grids for sale will not be necessary.

7.0 ECONOMIC ANALYSIS

Economic analysis of the proposed Montrose PRV-Hydropower requires all benefits and costs for the development to be calculated. The benefits include the sale of power. The costs include purchase of equipment, construction facilities, installing equipment and maintaining the development through the planning period. Ultimately, the economic analysis is necessary to determine whether or not the project is worth building. The planning period in the economic analysis is 50 years. It is conservatively assumed that the salvage value of the facility is zero after the planning period of 50 years.

7.1 Proposed Financial Plan and Cash Flow

The detailed financial plan and cash flow analysis was performed by using the above input and an interest rate of 4.0 percent after consultations with the city. The city may not need to use a loan for this small project. The proposed financial plan, annual cash outflow, annual cash inflow and present worth of benefits and costs and cash flow have been calculated. The financial analysis indicated that the benefit/cost rate is approximately 1.1. Because the benefit/cost ratio is greater than 1.0 and the cash flow is positive (typically, the cash flow is negative in the first numerous years for most hydroelectric projects) the proposed PRV-Hydropower project appears to be economically feasible. The simple payback period is approximately 16 years.

8.0 RECOMMENDATIONS / NEXT STEPS

Hydropower has relatively high up-front capital costs compared to other types of renewable energy resources such as wind and solar. However, once these capital costs are retired, hydropower provides an inflation-proof, inexpensive source of power. While incurring low operational and maintenance costs, hydro facilities typically have an expected service life of 50 to 80 years and thus represent a long-term investment.

The case study indicates that the proposed City of Montrose PRV-Hydropower project is technically and financially feasible with the proposed financial plan and cash flow analysis. It is recommended that the city proceed with the proposed Niagara PRV-Hydropower project.

There appear to be several sources for financing, including possible grants and low-interest loans to support small hydro development.

Based on these preliminary results, it is suggested that a full engineering study be developed to outline 1) technical options for development, 2) financing opportunities, and 3) possible supporting grants. If the district should decide to move forward, it is suggested that a multi-discipline project team be formed to manage and oversee the project.

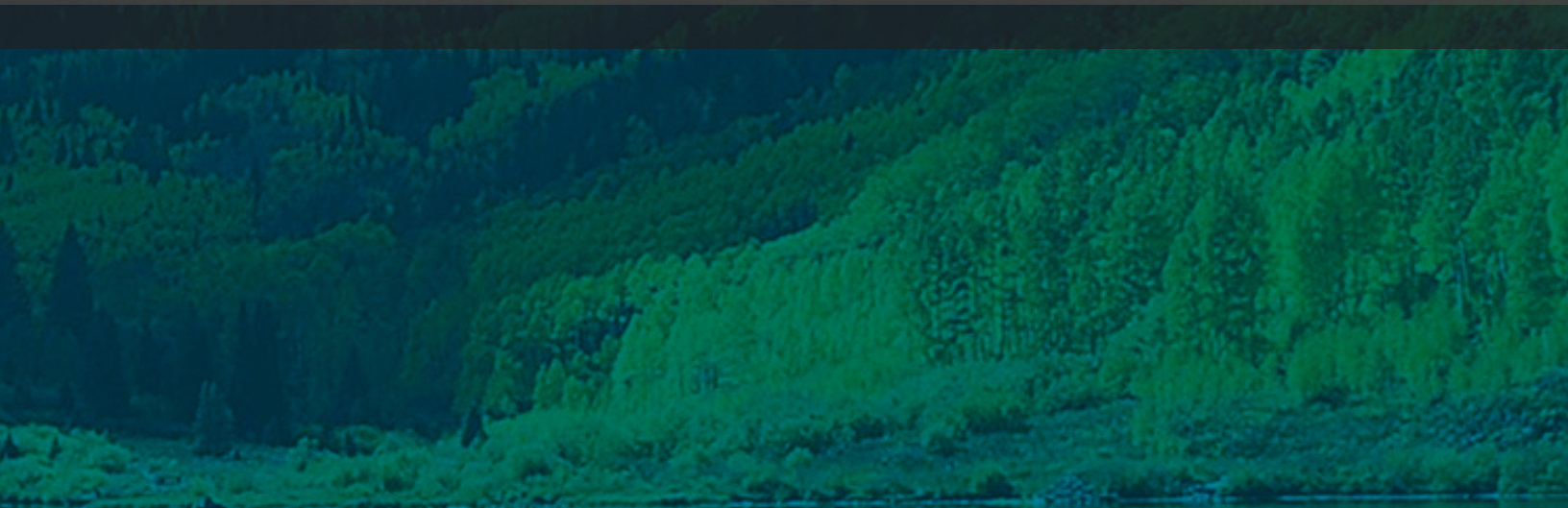
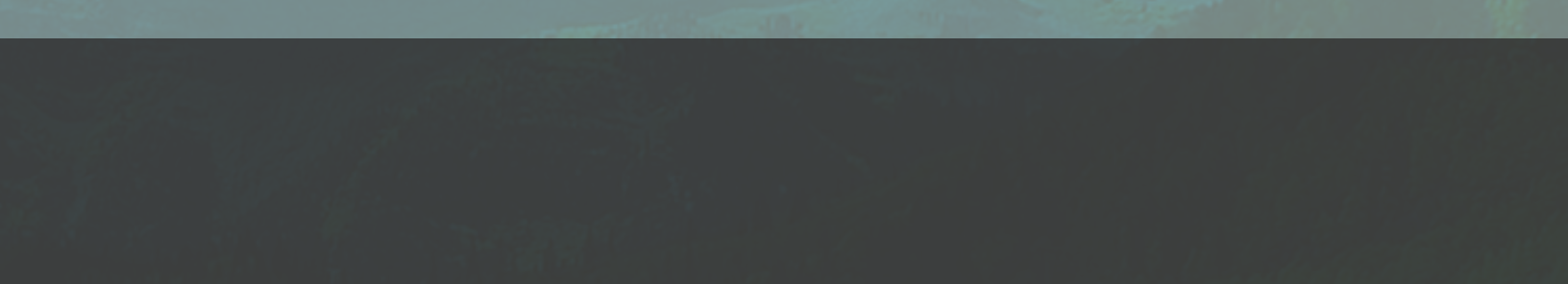

COLORADO
Energy Office