

Synthesis Report on the Use and Design of Snow Sheds to Protect Transportation Corridors Against Avalanches



APPLIED RESEARCH &
INNOVATION BRANCH

Jordy Hendrikx
Alan Jones
Andrew Schauer
Ryan Buhler



COLORADO
Department of Transportation

The contents of this report reflect the views of the author(s), who is(are) responsible for the facts and accuracy of the data presented herein. The contents do not necessarily reflect the official views of the Colorado Department of Transportation or the Federal Highway Administration. This report does not constitute a standard, specification, or regulation.

Technical Report Documentation Page

1. Report No. CDOT-2020-13		2. Government Accession No.		3. Recipient's Catalog No.	
4. Title and Subtitle Synthesis report on the use and design of snow sheds to protect transportation corridors against avalanches				5. Report Date September 2020	
				6. Performing Organization Code	
7. Author(s) Jordy Hendriks ¹ , Alan Jones ² , Andrew Schauer ¹ , Ryan Buhler ²				8. Performing Organization Report No.	
9. Performing Organization Name and Address ¹ Snow and Avalanche Laboratory, Department of Earth Sciences, Montana State University, Bozeman, MT, USA ² Dynamic Avalanche Consulting, Revelstoke, BC, Canada				10. Work Unit No. (TRAIS)	
				11. Contract or Grant No. 5337.08	
12. Sponsoring Agency Name and Address Colorado Department of Transportation - Research 2829 W. Howard Pl. Denver CO, 80204				13. Type of Report and Period Covered Final Report	
				14. Sponsoring Agency Code	
15. Supplementary Notes Prepared in cooperation with the US Department of Transportation, Federal Highway Administration TPF 5(337) - Transportation Avalanche Research Pool, Jamie Yount, CDOT Champion					
16. Abstract <p>This report provides a synthesis on the use and design of snow sheds to protect transportation corridors against avalanches. This report summarizes the various snow shed designs and standards, regulation environment, construction and operational costs, risk, benefits, loading considerations, operational and design considerations, and alternate methods employed when snow sheds are no longer needed, or when alternative long-term mitigation measures are employed.</p> <p>This report documents designs that are currently in use on transportation corridors, have been proposed, and those that are being designed in North America. We have documented differences in construction approaches, additional mitigation considerations (e.g. deflection berms), and the resulting residual risk to the transportation corridor. We also show examples from international jurisdictions, including Switzerland and Norway, for consideration for potential future snow shed designs in North America.</p> <p>Transportation corridors throughout the world employ a variety of snow shed designs to protect against snow avalanches. The design, cost, and residual risk is a function of a number of factors, including the character of the avalanches, the location of the corridor relative to the avalanche path, the frequency of avalanche debris on the corridor, the volume of traffic, and the engineering design and associated regulations determining the construction and operations of these structures. To help clearly illustrate these issues we have used three case studies and present a synthesis table to conclude.</p>					
17. Keywords Snow sheds, Avalanche, Risk, Mitigation, Transportation.				18. Distribution Statement This document is available on CDOT's website https://www.codot.gov/programs/research/pdfs	
19. Security Classif. (of this report) Unclassified		20. Security Classif. (of this page) Unclassified		21. No. of Pages 166	22. Price

SYNTHESIS REPORT ON THE USE AND DESIGN OF SNOW SHEDS TO PROTECT TRANSPORTATION CORRIDORS AGAINST AVALANCHES



Top left: Single Bench snow shed, BC, Canada (photo: Hendrikk); Top right: Solbjørneset-Hamnøy project, Lofoten, Norway (photo: Hendrikk)
Bottom left: Snow shed on Fv91Lyngen, Norway (photo: Hendrikk); Bottom right: Twin snow shed, BC, Canada (photo: Jones)

Report prepared for:

Transportation Avalanche Research Pooled fund (TARP)

Report prepared by:

Jordy Hendrikk and Andrew Schauer, Snow and Avalanche Laboratory, Department of Earth Sciences, Montana State University, Bozeman, MT, USA.

Alan Jones and Ryan Buhler, Dynamic Avalanche Consulting, Revelstoke, BC, Canada.



Contact:

Jordy Hendrikk

E: Jordy.hendrikk@montana.edu

P: +1 406 994 6918

Final Report Issued: September 30, 2020

Executive summary

This report provides a synthesis on the use and design of snow sheds to protect transportation corridors against avalanches. This report summarizes the various snow shed designs and standards, regulation environment, construction and operational costs, risk, benefits, loading considerations, and alternate methods employed when snow sheds are no longer needed, or alternative long-term mitigation measures are employed.

Our team combines the strengths from academia (Montana State University) and the consulting world (Dynamic Avalanche Consulting) to present a holistic view and experience working with snow sheds and alternative mitigation options in North America. We have leveraged our past consulting experience in the USA, Canada and internationally, working with various Department of Transportations and other transport agencies, and sought input from colleagues internationally to provide a robust synthesis of snow sheds to protect transportation corridors from avalanches.

This report documents designs that are currently in use on transportation corridors, have been proposed, and/or are being designed in North America. We have documented differences in construction approaches, additional mitigation considerations (e.g. deflection berms), and the resulting residual risk to the transportation corridor. We also show examples from international jurisdictions, including Switzerland and Norway, for consideration for potential future snow shed designs in North America.

As demonstrated in this report, transportation corridors throughout the world employ a variety of snow shed designs to protect against snow avalanches. The design, cost, and residual risk is a function of a number of factors, including the character of the avalanches, the location of the corridor relative to the avalanche path, the frequency of avalanche debris on the corridor, the volume of traffic, and the engineering design and associated regulations determining the construction and operations of these structures.

To help clearly illustrate these issues we have used three case studies:

- Proposed snow sheds on Little Cottonwood Canyon, Utah, USA;
- A current snow shed on Rogers Pass, British Columbia, Canada; and
- A historical snow shed removal and alternative on Snoqualmie Pass, Washington, USA.

We conclude with a summary table that presents the most critical aspects that require consideration when snow sheds are being considered for long term avalanche mitigation.

Table of Contents

Executive summary	1
List of figures.....	6
List of Tables	9
1. Introduction.....	10
2. Background.....	11
2.1 Avalanche mitigation.....	11
2.2 Snow Sheds	12
2.3 Multi-hazard sheds.....	14
2.4 Geographic Scope:.....	14
3. Overview of historical, current and proposed snow sheds in North America	15
3.1 Colorado	15
3.2 Utah	18
3.3 Washington	20
3.4 Wyoming	22
3.5 Alaska	23
3.6 Railroads in the USA.....	24
3.7 Canada – Roads	26
3.8 Canada - Railroads.....	33
3.9 Canada – Industrial.....	35
4. Summary and international examples from other jurisdictions.....	37
4.1 Overview and technical background.....	37
4.2 International examples of snow shed designs.....	39
4.3 Construction and Maintenance costs:	49
4.4 Damage:	50
5. Overview of relevant US federal and Canadian regulations for consideration.....	52
5.1 United States	52
5.2 Canada.....	55
6. Snow and avalanche load considerations and methods	57
6.1 Swiss guidelines.....	57

6.1.1	Design case.....	57
6.1.2	Reference section and geometric data.....	58
6.1.3	Evaluation of forces acting on structure.....	60
6.1.4	Effect of Rock and /or Trees in Flowing Avalanche	62
6.2	Example loads.....	62
7.	Summary of design and operational issues associated with snow sheds	64
7.1	Road grade	64
7.2	Road curvature (vertical and horizontal alignment)	65
7.3	Road width and traffic separation with barriers.....	65
7.4	Snow shed height	66
7.5	Lighting	67
7.6	Icing	68
7.7	Snow shed length/overspills	69
7.8	Back spills	70
7.9	Snow cornices and icefall	71
7.10	Snow removal.....	72
7.11	Structural damage to snow sheds.....	73
8.	Case study One: Proposed snow shed, Little Cottonwood Canyon, Utah, USA.	75
	Location:	75
	Timeframe:	75
	Purpose & Motivation:	75
	Location and design criteria:	75
	Risk and residual risk	78
	Costs:	79
	Alternatives:	80
	Summary:	80
9.	Case study Two: Current snow shed, Single Bench, Glacier National Park, B.C., Canada. 81	
	Location:	81
	Timeframe:	81
	Purpose / Motivation:	81
	Location and design criteria:	83

Rehabilitation, Operations & Maintenance costs:	85
Risk and residual risk:	87
Operational issues and challenges	88
Summary:	89
10. Case study Three: Removed snow shed, Snoqualmie Pass, Washington, USA.	90
Location:	90
Timeframe:	90
Purpose / motivation:	90
Location and design criteria:	91
Costs:	93
Ongoing maintenance costs:	94
Risk and residual risk	94
Summary:	95
11. Summary	96
12. References	99
Appendix A: Summary table of snow sheds in North America	105
Appendix B – Colorado DOT	112
B1. East Riverside Snow shed (As-Built)	112
B2. East Riverside Snow shed (Proposed)	116
Appendix C – Utah DOT	120
C1. Proposed Dam Chute Snow Shed on US-189 in Provo Canyon	120
C2. Proposed Snow Sheds on SR-210 in Little Cottonwood Canyon	122
Appendix D – Washington DOT.....	126
D1. Proposed Keechelus Dam Snow Shed (Proposed 2011, not built)	126
D2. Lake Keechelus Snow Shed (Built 1951)	130
D3. Airplane Curve Snow Shed (Designed 1950, not built).....	134
D3. Keechelus Lake Snowshed (1931, 1933).....	139
Appendix E – Wyoming DOT	142
E1. Proposed Glory Bowl Snow Shed (Proposed 1992, not built).....	142
Appendix F – Parks Canada, Glacier National Park.....	144
F1. Pioneer (built 1961).....	144

F2. Tupper #1 (built 1962) and later joined to 1962 re-build of Pioneer 148

F3. Single Bench (built 1978)..... 151

Appendix G – BC MoTI..... 157

G1. Great Bear (built 1986) 157

G2. Lannark (built 1962)..... 162

List of figures

Figure 1:	Two-lane concrete Twin snow shed with seasonal snow and avalanche debris. Rogers Pass, British Columbia	11
Figure 2:	312m long stone-arched snow shed built at Splügenpass in 1843. The snow shed was in operation until 1950	12
Figure 3:	Oblique view of the East Riverside avalanche path and Riverside snow shed	16
Figure 4:	The Riverside snow shed covered in avalanche debris following mitigation work by the Colorado Department of Transportation. March, 2019.....	17
Figure 5:	White Pine Chutes 1-4 and White Pine, RAMMS 100-year velocity (m/s), and proposed snow sheds (grey) and guiding berms (white). Light grey outlines indicate the maximum path boundaries from updated avalanche path mapping	19
Figure 6:	The concrete East Shed was built along Lake Keechelus on I-90 on Snoqualmie Pass in 1950 and now since been removed.....	21
Figure 7:	The Crater Lake Bridge over the Glory Bowl avalanche Path, Teton Pass	23
Figure 8:	Named Avalanche Paths and corresponding Railway snow sheds	26
Figure 9:	Pioneer snow shed built with multi-plate construction, 1961. This shed was joined with the Tupper #1 shed in 1966.....	27
Figure 10:	Lanark snow shed built using prefabricated concrete, prior to construction of the wingwalls. Note the guiding berm on the left	29
Figure 11:	The cantilevered wing walls on the Lanark snow shed were constructed after the construction of the snow shed. The structures of the wing walls are independent from the shed structure and the additional load from the walls does not affect the snow shed.	30
Figure 12:	Great Bear snow shed, Coquihalla Highway 5, British Columbia, Canada. Photo is looking eastwards, with steep (8%) grade requiring eastbound trucks to have chains, which increases wear on the roadway surface	31
Figure 13:	Snow shed in concrete at the Canadian Pacific Railway, built in 1960	33
Figure 14:	Mt. Stephen snow shed in Yoho National Park, British Columbia, Canada. The shed protects the railway from avalanches, debris flows, and icefall hazards. Avalanches pass over the railway track and affect the highway.	34
Figure 15:	Two wood structure snow sheds that protect the Canadian Pacific Railway at Three Valley Gap near Revelstoke, British Columbia, Canada. Avalanches flow across the shed onto the lake, currently frozen in this photograph.....	35
Figure 16:	Installation of the multi-plate structure at Galore Creek Mine access road North Portal canopy after excavation and site preparation (left) and during completion of the backfilling (right).	36
Figure 17:	The Gotthard Highway in February, 1999	39

Figure 18: Snow arch snow shed on Splügenpass (constructed 1843 – 1846, length 312 m) as viewed from the outside (Photo: Google Earth, 2020), the inside and the cross section	40
Figure 19: Prefabricated snow shed in the Schöllenen Gorge, as viewed from the outside and inside.....	41
Figure 20: Monolithic Snow shed in Val Raschitsch as viewed from the outside on the side of the road, in profile showing the guiding berms, and the cross section.....	42
Figure 21: Snow shed Salez in Davos (constructed 1982, length 400 m) as viewed from the outside, the inside and the cross section	42
Figure 22: Snow shed Cassanawald (constructed 1986, length 1235 m) as viewed from the outside and inside, and the cross section	43
Figure 23: A snow shed near Svensby, Lyngen, Norway using a pre-cast concrete arch and backfill design. The guiding berm can be seen in the Google Earth Image	44
Figure 24: A snow shed near Elvevoll, in Troms, Norway (left) and in Olden, Vestland as examples of a CMP snow shed design.....	46
Figure 25: The snow sheds as part of the Solbjørnneset-Hamnøy project.....	47
Figure 26: The Great Bear snow shed on the Coquihalla Highway 5, British Columbia, showing the addition of artwork in the concrete wing walls. Photo: R. Buhler.....	48
Figure 27: Wildlife overpass on Highway 1 near Lake Louise, Alberta, showing the addition of architectural design elements to the entry, including stacked boulders, trees and vegetation. Similar design elements can be used for snow sheds to enhance the visual appeal and blending in with the natural environment.	48
Figure 28: An avalanche on October 7, 1996 damaged the east portal of Homer tunnel. Impact pressures of 650-700 kPa were estimated, and resulted in damage to the reinforced-concrete portal structure	51
Figure 29: Geometric data and initial data for the interface position for flowing avalanches...	59
Figure 30: Deviation force zone and distribution of deviation forces. When planning snow shed construction and design, construction in zone should be avoided if possible, as this is the area of the greatest deviation force and overall loads.....	61
Figure 31: A 2018 accident involving three transport trucks occurred in one of narrow, undivided MoTI snow sheds east of Revelstoke	66
Figure 32: Overhead damage to the Tupper #1 snow shed has occurred where the original metal arch-shaped Pioneer shed joins the flat-roofed concrete Tupper #1 shed	67
Figure 33: In March 2019, icing in the Great Bear snow shed lead to a five-vehicle collision which sent two people to the hospital.....	69
Figure 34: A 2007 overspill in the Tupper #1 snow shed completed blocked the shed portal and caused a lengthy road closure while the deposit was removed	70
Figure 35: Two snow shed maintenance issues: (1) overhanging cornice snow and (2) snow accumulation at the portal	72
Figure 36: Single Bench snow shed in Rogers Pass, BC showing evidence of debris and rockfall impacts on the concrete roof slabs	73

Figure 37: Debris and vegetation accumulation on top of the combined Tupper #1 (right) and Pioneer (left) snow sheds observed in 2017. A major shed rehabilitation program by Parks Canada has removed this debris and improved the management of surface and subsurface water	74
Figure 38: Little Pine RAMMS 100-year velocity (m/s), proposed snow shed with guiding berms (dark grey) and length without guiding berms (light grey).	77
Figure 39: Proposed 3-lane snow shed cross section for SR-210.....	78
Figure 40: Single Bench avalanche path above the Single Bench snow shed. Single Bench avalanche path is the main path in the center of the photo, directed over the shed and confined by lateral guiding berms. The Mounds avalanche path is immediately west (photo left) of the shed. The Crossover avalanche path affects the shed from the opposite (south) side of the valley, requiring protection of the downslope shed wall.....	82
Figure 41: Single Bench overspill at the west portal due to a glide slab avalanche from the adjacent Mounds avalanche path, April 10, 2012.....	83
Figure 42: Single Bench snow shed typical cross section	84
Figure 43: Aerial view of the East Shed in summer prior to its removal, showing the exposed east bound lanes, and covered west bound lanes.	91
Figure 44: East Shed project area overview showing location of current highway, Keechelus Lake, seven East Shed avalanche paths, and proposed locations of bridges (green lines) and piers (pink dots)	93

List of Tables

Table 1:	Recommended action combinations (AC) for avalanche protection galleries for the limiting state of the payload (ULS) and usability (SLS).....	38
Table 2:	Load cases to determine the actions induced by snow and avalanches..	58
Table 3:	Geometric data for calculating forces on the shed.....	59
Table 4:	Specific weights and coefficients of friction for different types of snow and sliding surfaces	60
Table 5:	Forces acting on the top of a shed.	61
Table 6:	Typical loads on snow sheds (total load due to avalanches and snow deposit) from SLF consulting reports in Switzerland.....	63
Table 7:	Estimated rehabilitation costs in CAD\$ for five snow sheds in Glacier National Park, 2015-2020 upgrades.....	86
Table 8:	Estimated annual operation and maintenance costs in CAD\$ for five snow sheds in Glacier National Park, plus a summary for the Single Bench snow shed.	87
Table 9:	Estimated I-90 6-lane snow shed operational and maintenance costs.	95
Table 10:	Important considerations for long-term avalanche mitigation using snow sheds.....	97

1. Introduction

This report was prepared for the Transportation Avalanche Research Pooled fund (TARP) members to provide a synthesis on the use and design of snow sheds to protect transportation corridors against avalanches.

Transportation corridors throughout the world employ snow sheds to protect against snow avalanches. Designs and specifications vary and result in different styles, costs, and residual risk. The purpose of this report is to provide a synthesis that provides information on the following:

- 1) Which designs are currently in use, being constructed, or in the design phase;
- 2) The design criteria, including grade and alignment concerns, residual risk, and estimated cost of construction of these structures;
- 3) Ongoing maintenance costs;
- 4) The effectiveness of snow sheds;
- 5) Where and why snow sheds have been removed or otherwise put out of service either seasonally or permanently;

In addition, this synthesis report provides examples of various designs including both reinforced concrete and Multi-Plate construction, and provides examples from other international jurisdictions.

This report is structured in several sections that address one or more of the items listed above. We also use three case studies (**Sections 8, 9 and 10**) to illustrate and provide more detailed information and discussion on these topics.

This report was prepared by Jordy Hendrikx, PhD., Director of the Snow and Avalanche Lab in the Department of Earth Sciences at Montana State University (MSU), Andrew Schauer, MSc., Researcher in the Snow and Avalanche Lab in the Department of Earth Sciences at Montana State University (MSU), Ryan Buhler, MSc., EIT, and Alan Jones, MSc., P.Eng., Senior Engineer and Principal Consultant at Dynamic Avalanche Consulting (Dynamic). This report uses both publicly available information and where permission was given, relevant client reports and designs.

2. Background

2.1 Avalanche mitigation

Avalanche hazard mitigation can be achieved using a variety of approaches and systems, each with differing advantages and disadvantages. Two general approaches can be used to mitigate avalanche hazards for road and rail corridors:

- Short-term measures
- Long-term measures

Short-term measures are typically guided by an operational framework and avalanche forecasting. Short-term measures typically include terrain restrictions and closures or active control options using explosives, which include measures such as: Artillery, Hand charges, Helicopter control using explosives and/or gas devices, Remote Avalanche Control Systems (RACS) or Explosive trams.

Long term measures typically relate to passive control options, which include measures such as: Snow retaining structures; Re-alignment or location planning, i.e. avoidance; Avalanche bridges; Earth berms (stopping dams or diversion berms); Catching basin (or check dam system); Stopping walls and Snow sheds or tunnels.

In general, long-term measure control systems are divided into systems that either hold the snow in place in the starting zone (i.e. snow retaining structures such as nets) or protect the corridor by diverting or stopping avalanche flow in the track or runout zone (e.g. snow sheds, avalanche bridges, re-alignment, diversion berms, catching basins, stopping walls). This report will focus specifically on snow sheds (**Figure 1**).

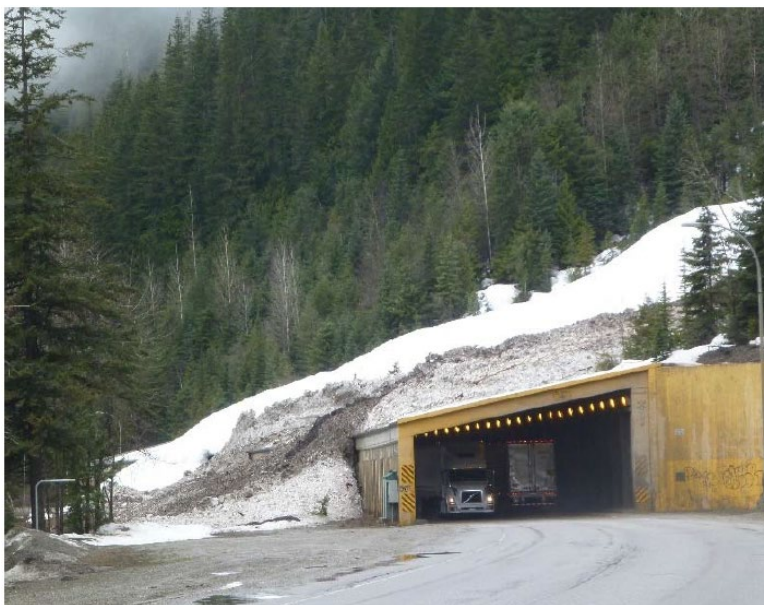

Figure 1 Two-lane concrete Twin snow shed with seasonal snow and avalanche debris. Rogers Pass, British Columbia (Photo: A. Jones)

2.2 Snow Sheds

Snow sheds, sometimes called avalanche galleries, are an example of long-term measures, or passive protection structures, designed to protect transportation corridors such as roads and railroads from avalanches. A snow shed is a structure that acts like a roof over a corridor, and is designed to direct the avalanche over, rather than onto the road or railway (Rudolf-Miklau et al., 2015). However, given that snow avalanche loads can be very high, snow sheds are more similar to a bridge than a roof with respect to their design loads. The static and dynamic forces exerted by snow and avalanches on a snow shed are a function of snow depth, snow density, flow velocities, flow height and slope deviation angle (ASTRA/SBB, 2007).

Globally, snow sheds are among the most important permanent mitigation structures to protect transportation corridors from avalanches (Margreth and Platzer, 2008). Snow sheds have historically been constructed using a variety of materials, including: timber, stone, reinforced concrete and corrugated metal pipe (CMP). In the European Alps, snow sheds are among the oldest structural avalanche protection measures, with some of the earliest structures built under the direction of Napoleon between 1801 and 1805 (e.g. Simplon Pass, Switzerland). Some of these structures are still present today (e.g. snow shed on Splügenpass, Switzerland built in 1843) (Margreth and Platzer, 2008) (**Figure 2**).



Figure 2: 312m long stone-arched snow shed built at Splügenpass in 1843. The snow shed was in operation until 1950 (Photo: Margreth and Platzer, 2008).

Snow sheds on ancient narrow roads and single track railways were typically designed on a trial-and-error basis. Estimates of loadings, if made at all, were likely only educated guesses. The stone arch sheds were sufficiently strong to withstand unknown snow and avalanche forces, and the timber sheds, if they failed, could be replaced using stronger beams. While the

narrow old sheds were relatively inexpensive structures, modern highways require large and costly structures that meet stringent design standards, and their location and design should be based on careful studies (Schaerer, 1967).

While snow sheds are an efficient and relatively safe avalanche defense, their high cost when used for modern highways means that they can only be built at sites where other mitigation methods are impracticable or do not offer sufficient protection.

Schaerer (1967) suggests that the decision as to whether a snow shed should be built at a given site should be made only after the following factors are considered:

- Frequency of avalanche occurrence;
- Size of the avalanches, the volume & type of snow that could be deposited on the corridor;
- Length of time required to remove the snow;
- Density of traffic;
- Length of time that can be allowed for interruption of traffic; and
- Degree of safety required.

To arrive at a conclusion based on these factors, several years of observations on the size and frequency of occurrence of avalanches at the site are necessary. The time required to remove snow deposits can be estimated from these observations. It must then be decided whether the interruption of traffic caused by the occurrence of an avalanche is serious enough to warrant the cost of a defense structure (Schaerer, 1967).

For a snow shed to be completely effective at mitigating the avalanche risk, it needs to cover the full width of an avalanche path for the given design return period (e.g. 1 in 100 years). Margreth and Platzer (2008) suggest that insufficient snow shed lengths are the most common reason for failure in the performance of these mitigation structures. Depending on the avalanche path, it is sometimes possible to reduce the required width of the snow shed by constructing lateral deflection berms or walls to constrain the avalanche flow. The location of the snow shed within an avalanche path also needs to be carefully considered, with optimal placement reducing the deviation (change in angle) of the avalanche flow as it reaches the shed. If this is not possible, the deviation point of the slope should be positioned at a distance of more than six times the flow height of the design avalanche uphill of the shed. For example, if the design avalanche event has an estimated flow height of 2 m, then the deviation point should be at least 12 m upslope from the snow shed. Consideration also needs to be given to the outside, or downslope wall, which should be closed or protected with slats or wire mesh if the terrain below the snow shed is not steeply inclined; this prevents back-spill of avalanche deposits into the snow shed. However, enclosing the snow shed on all sides typically changes the classification of the snow shed into a tunnel in accordance with the US Federal Highway Administration (FHWA) National Tunnel Inspection Standards (NTIS), and also affects the

ventilation and lighting considerations. More details on these considerations are provided in **Sections 5 and 6**.

2.3 Multi-hazard sheds

Rockfall sheds as well as snow sheds are used in mountainous regions to protect transportation routes from gravitational mass movements. In some mountainous regions, a shed might be exposed to several forms of gravitational mass movement, with snow avalanches during winter and spring seasons, and rockfall or debris flow during alternating thawing-freezing periods or warm seasons. Therefore, in some cases a snow shed may need to be designed for multiple natural hazards.

For both snow avalanche and rockfall hazards, there are well documented guidelines on determining both static and dynamic loads from each (e.g. ASTRA/SBB. 2007, Gerber, 2006), with rockfall typically resulting in higher dynamic loads. However, there is limited guidance on the potential interactions between these two hazards. While it is acknowledged that these hazards seldom occur simultaneously, there are instances where this is possible. Platzer (2008) notes that if snow sheds are loaded by both avalanches and rockfall, the two actions must not be combined, but rather dealt with individually. Platzer (2008) also notes the influence of snow cover and/or avalanche deposits on the damping of the dynamic avalanche loads and suggests that similar affects (i.e. change of geometry or loads) is possible due to the presence of rock deposits on the avalanche sheds. Likewise, snow deposits may have a damping effect on rockfall sheds, especially in spring when rockfall hazards are more frequent.

This report focusses solely on snow and avalanche loads on snow sheds (**Section 6**), and we do not attempt to account for multi-hazard loading. We note that this is an area of ongoing research and we encourage a review of Gerber (2006) for rockfall shed loading.

2.4 Geographic Scope:

Snow sheds have been constructed in many alpine countries around the world. This report focusses primarily on snow sheds on transportation corridors constructed in North America (i.e. USA and Canada); however, we also draw on experience and knowledge from Norway and the European Alps from which many of the design concepts originated.

It is outside the scope of this report to provide details on snow sheds constructed for all industrial applications (e.g. mining sites) in North America, or all other regions around the World where snow sheds are present. These other regions include, but are not limited to, Eastern and Southern Europe (e.g. Turkey), South America (e.g. Chile), Central Asia (e.g. Salang Pass, Afghanistan), or Japan. Accordingly, this synthesis report does not reflect the global range of potential snow shed designs, but rather presents a synthesis of current use in North America and best practice from international examples and guidelines. Our aim was to present a summary of options, rather than an exhaustive documentation of every possible combination and permutation of snow shed.

3. Overview of historical, current and proposed snow sheds in North America

This section provides an overview of historical, current and proposed snow sheds in North America. We have focused on snow sheds that protect public roads and railway corridors, and have explicitly not excluded snow sheds at industrial sites (e.g. mines).

Data for these snow sheds were collated from TARP members, mainly from key contacts at respective Department of Transportations (DOTs), railroad operators, and consultants that have worked on, or are actively working on snow shed related projects in North America. A summary table (**Appendix A**) is presented at the end of this report that includes details on the following parameters (where known):

- Organization / Jurisdiction & Contact(s): Name of organization and key contact(s)
- Status: Historical / Current / Proposed
- Name(s): Name of the snow shed(s)
- Details / Location: Approximate location
- Time period: Year constructed and / or removed
- Construction methods: Summary of construction method / materials
- Length (ft / m): Snow shed length (ft / m)
- Estimated design loads (psf / kPa): Estimated static and dynamic loads
- Estimated risk reduction: Estimated risk reduction as percentage, or qualitative.
- Cost (date) / Cost (now) ¹: Cost in USD or CAD at time of construction and adjusted for 2020.
- 2020 Est. Cost per ft and m: Current costs in USD or CAD per ft and m.
- Comments: Relevant additional comments
- References: References to report / articles

The following sections provide a brief narrative summary for all of the snow sheds presented in the summary table and is organized by jurisdiction (**Appendix A**).

3.1 Colorado

Within the state of Colorado, the Colorado Department of Transportation (CDOT) manages two snow sheds: the Riverside Snow Shed on Highway (Hwy) 550 and the Alberta Snow Shed near Wolf Creek Pass on US160. Other than the proposed Phase 2 and 3 of the Riverside Snow Shed, no other proposed or historical snow sheds have been documented in Colorado.

¹ Costs in 2020 are calculated using the Consumer Price Index (CPI) Inflation Calculator from Alioth Finance, 2020). <https://www.officialdata.org/>

The Riverside Snow shed is located on Hwy 550 approximately 5 miles (8 km) south of Ouray, and is situated below the East Riverside path off of Mount Abrams (**Figure 3**). The original design proposed a snow shed that was 1280 ft (390 m) long be built in three phases. Phase 1 would be 450 ft (137 m) long, and protect the highway from the East Riverside Path, eliminating most of the risk associated with that path. Phase 2 would extend the shed 465 ft (141 m) to the south, which would eliminate the risk posed by avalanches on the West Riverside Path of Hayden Mountain. Phase 3 would extend the shed 365 ft (111 m) to the north, protecting the highway from slides starting to the north of the East Riverside path (Mears, 1992a, Mears, 2012).



Figure 3: Oblique view of the East Riverside avalanche path and Riverside snow shed (Photo: Mears, 1992).

Phase 1 Construction was completed in 1985, but the shed was only built to a length of 180 ft (55 m) due to budget constraints (Figure 3). The shed was completed at cost of \$2,550,000 (equal to \$6.1 million in 2020², or approximately \$111,000/meter or \$34,000/ft unit cost) and

² Costs in 2020 are calculated using the Consumer Price Index (CPI) Inflation Calculator from Alioth Finance, 2020).
<https://www.officialdata.org/>

accounted for a 50% reduction in avalanche hazard in the Riverside avalanche area (Mears, 1995a). The original design for the Riverside Shed called for a concrete roof to be anchored on a ledge cut into the bedrock on the uphill side of the road. During the early stages of construction, engineers found the rock was not suitable for the proposed design, and the back wall was instead built of reinforced concrete. The shed was designed for static loads of 1800 psf (86.2 kPa) and avalanche impact loads of 1000 psf (47.9 kPa) (Mears, 2012; Mears, 1992a).

In March 1992, a small avalanche blocked the highway roughly 100 ft (30 m) to the north of the snow shed, stranding two motorists and two CDOT employees in the snow shed. Two additional CDOT employees were buried by a second avalanche in the same vicinity while clearing the road, and one of them did not survive the avalanche (Mears, 1992b). The Riverside Shed is still in use today. The stretch of Highway 550 between Ouray and Durango crosses 95 avalanche paths, and is managed with forecasting, explosives mitigation, and road closures, in addition to the Riverside Shed. The recent March 2019 avalanche cycle resulted in both portals being overtopped and the closure of Red Mountain pass for several months (**Figure 4**).



Figure 4: The Riverside snow shed covered in avalanche debris following mitigation work by the Colorado Department of Transportation. March, 2019 (Photo: CDOT).

The Alberta snow shed is located on US 160 near Wolf Creek Pass and is situated below the Alberta slide paths (Salek, 2013). The shed is 379 ft (115 m) long and protects the highway from the Alberta slide paths. The snow shed is curved, and has been the site of numerous vehicle accidents, which are likely due to icing and the nature of the relatively straight and fast road before the snow shed. The shed was built in 1965 after several winters of heavy snowfall, and two fatalities in the winter of 1950-51. It is now rarely impacted by avalanches due to an

effective forecasting and control program, and due to its age and lack of utility, will most likely not be replaced at the end of its service life (Mears, 2012; Wilbur, *pers comm.*, 2020). There is little other technical information available regarding its costs and design criteria.

Operational costs are relatively low for these two snow sheds, with a recent lighting upgrade and utility costs for lighting representing the largest direct costs. The lighting upgrade in 2019 for the Riverside Snow Shed was approximately \$20,000. The utility costs were documented at approximately \$15,000 for the Riverside Snow Shed for a 12 month period (November 2018 to March 2020, excluding March-June 2019 when lights were damaged, or \$1250/month) and \$42,000 for a 12 month period (April 2019 to March 2020, or \$3500/month) for the Alberta Snow Shed, which is more than the twice the length of the Riverside Snow Shed. In addition to these utility costs, a biannual inspection of the structure is completed by CDOT staff. Further details for these Colorado snow sheds are presented in **Appendix A** and **Appendix B**.

3.2 Utah

Within the state of Utah, the Utah Department of Transportation (UDOT) has requested proposals for potential snow sheds along two road corridors: Highway 189 (Provo Canyon) and State Route (SR) 210 (Little Cottonwood Canyon). No other historical or current snow sheds were documented.

Along Highway 189 (Provo Canyon), there have been three studies proposing a 130-ft (40-m) snow shed protecting the stretch of US-189 exposed to the Dam Chute in Provo Canyon (McClung and Conger, 2001; Mears, 1995b; Parsons Brinckerhoff, 2003).

McClung and Conger (2001) also investigated the potential need for an additional structure protecting the stretch of elevated highway below the Power Plant path. They estimated a return interval of 100 years for an avalanche capable of impacting the section of raised highway in the runout zone, which is sufficiently infrequent to be considered an acceptable level of risk for a state highway. Both McClung and Conger (2001) and Parsons Brinckerhoff (2003) recommended maintaining the forecasting, closure and control program in addition to the Dam Chute snow shed in order to most efficiently reduce the avalanche hazard.

The Dam Chute snow shed was proposed to be 130 ft (40 m) long, and was designed for total loads (impact and static loads combined) of 292 psf (14 kPa), if the area upslope of the snow shed were filled with compacted earth to minimize impact forces perpendicular to the flow of an avalanche. If the shed were to be constructed without the upslope fill, total design loads were estimated to be 5117 psf (245 kPa), due to the sharp change in flow angle (deviation force zone), resulting in more surface area oriented perpendicular to the avalanche. The proposed shed would be constructed of reinforced concrete, and would cost an estimated \$1.8 million in 2003, equal to roughly \$2.5 million in 2020 (\$62,500/meter or \$19,200/ft). The most recent designs by Parsons Brinckerhoff (2003), also recommended excavating the channel upslope of

the shed and inclusion of guide walls 16 ft (5 m) tall on either end of the roof of the snow shed to direct avalanche debris and prevent it from piling up on the ends of the snow shed.

In Little Cottonwood Canyon (SR-210), snow sheds options were evaluated by Schaerer (1999), Fehr & Peers Associates (F&P), (2006) and Dynamic (2018a; 2018b; 2019). Alternatives to snow sheds including a tunnel and gondola were also evaluated by F&P (2006) and Dynamic (2018a; 2018b).

F&P (2006) and Schaerer (1999) proposed a total of 2485 ft (757 m) for the three snow sheds in the White Pine Chutes 1-3, White Pine and Little Pine avalanche paths. These proposed snow sheds would not mitigate the hazard on White Pine Chute 4. All of these paths are located near mile marker 9, just below the white pines trail head parking area, in the lower canyon. Dynamic (2018b; 2019) used a combination of field-based investigations, historical observations, and RAMMS avalanche modelling and proposed slightly shorter total snow shed length of 2465 ft (751 m) and included mitigation of White Pine Chutes 4. They achieved this with the proposed addition of guiding berms for White Pine and Little Pine paths, which shortens the overall length of the required snow shed and reduces the likelihood of over spills at the portals (Figure 5).

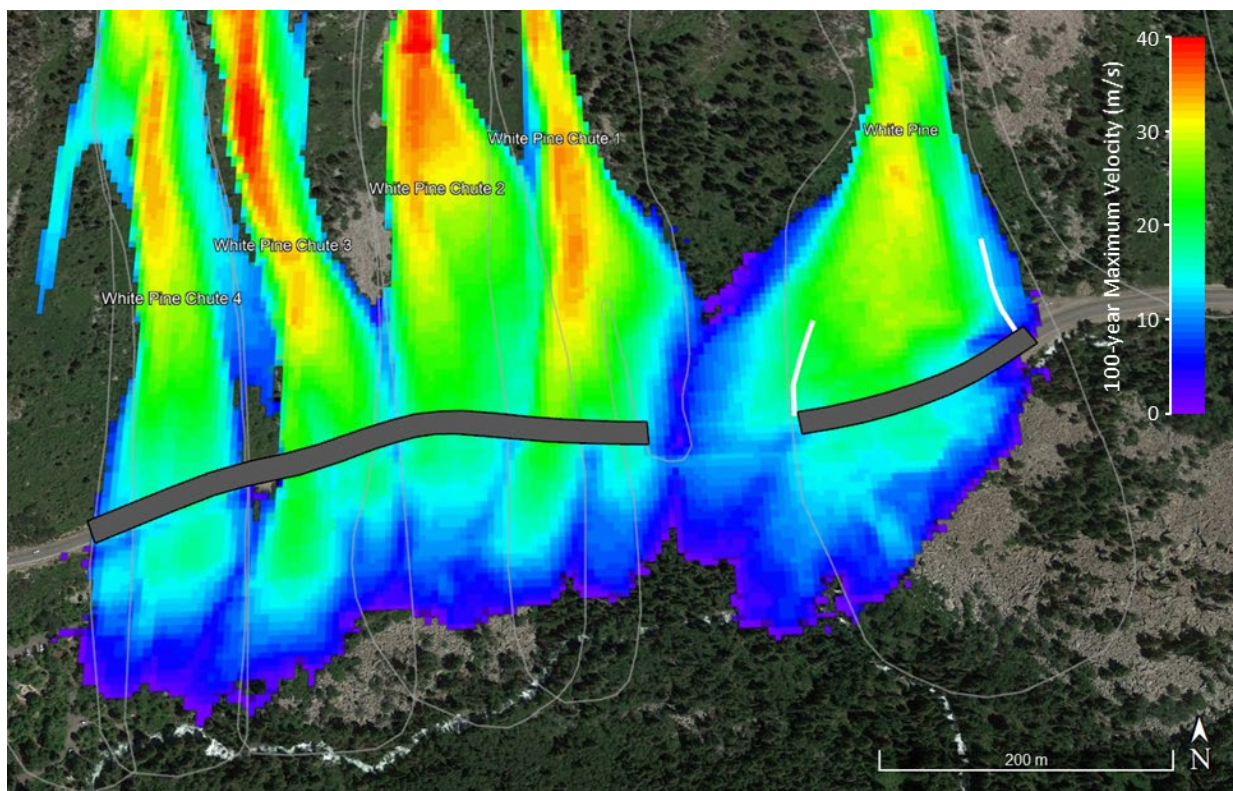

Figure 5: White Pine Chutes 1-4 and White Pine, RAMMS 100-year velocity (m/s), and proposed snow sheds (grey) and guiding berms (white). Light grey outlines indicate the maximum path boundaries according to updated avalanche path mapping (from Dynamic, 2018b)

Without guiding berms in place, Dynamic (2019) proposed that the snow sheds would need to be longer to reduce the likelihood of overtopping the snow shed entrances. They recommended a total increase of 500 ft (152 m), with White Pine increasing from 640 ft (195 m) to 835 ft (254 m) (195 ft / 60 m increase), and Little Pine increasing from 465 ft (141 m) to 770 ft (235 m) (305 ft / 93 m increase), and no change in length for the White Pine Chutes 1-4 snow shed because guiding berms were not previously recommended, but did recommend a 10 ft (3 m) parapet wall be included on the western end of this snow shed to prevent avalanche snow entering the western portal (from overspills).

Dynamic (2018b) used the Swiss guidelines for snow sheds ASTRA/SBB (2007) to estimate the 100-year normal and parallel loads. The design case was determined to be Case 3, where a large avalanche (10 ft / 3 m flow depth) flows over existing snow cover (15 ft / 4.5 m depth), combined with previous avalanche deposits (13 ft / 4 m depth). In addition to the design case, they also determined that if the snow shed were completely covered by seasonal snow and avalanche debris without snow management, a passive snow load (Case 5) to the exterior (downhill) wall of the snow sheds should be expected for White Pine and Little Pine, and a dynamic load (Case 6) from the adjacent side of the valley from the avalanche path Scotty's Bowl for Little Pine should be expected. The resultant normal loads were between 790 and 697 psf (37.7 - 33.4 kPa), and the resultant Parallel loads were between 116 to 105 psf (5.6 kPa – 5.0 kPa). Passive loads were 118 psf (5.6 kPa), and the dynamic load on the outside wall on Little Pine was 188 psf (9.0 kPa).

These snow sheds were estimated to cost between \$72 and \$86 million depending on the length, alignment and use of guiding berms (Utah Department of Transportation, 2019). The lower cost reflected construction costs, while the higher end cost included additional items like permitting, professional services, design, environmental mitigation and insurance. This results in a unit cost of approximately USD \$74,000- \$88,000/m or \$23,000 - \$27,000/ft.

These shed were estimated to provide a 24% reduction in the Avalanche Hazard Index (AHI) (Schaerer, 1989), and 34% reduction in residual AHI for estimated 2050 traffic volume of 11,300 vehicles per day for a three-lane snow shed relative to the AHI and residual AHI without snow sheds for the 2018 traffic level (Dynamic, 2018b). Further details for these snow sheds are presented in **Appendix A** and **Appendix C. Section 8 provides a more detailed case study description of these proposed snow sheds in Little Cottonwood Canyon.**

3.3 Washington

Within the state of Washington, the Washington Department of Transportation (WSDOT) has removed the East and West snow sheds, and requested proposals for one potential new snow shed at the site of the East Shed. No other historical or current snow sheds were documented.

A two-lane wooden snow shed, East Shed, was constructed on I-90 Snoqualmie Pass in the 1930's adjacent to Lake Keechelus. The East Shed was replaced with a concrete shed in 1950, at which time the highway was still two lanes wide. The shed was 500 ft (152 m) long and cost

\$1.2 million in 1950 (equal to \$12.8 million in 2020, a unit cost of \$84,200/meter or \$25,600/ft) (Figure 6). At the same time, the West Shed was built along an area known as Airplane Curve. Both sheds were built to cover both lanes of the two-lane highway at the time. The West shed remained in place until its removal in the early 1980's. The highway was widened to four lanes in the late 1950's, but the sheds remained unchanged. If an avalanche blocked the unprotected eastbound lanes, traffic was re-routed through the East Shed. However, before the implementation of an avalanche forecasting and control program in 1971, it was not uncommon for vehicles to be caught in avalanches prior to road closures. The West Shed was removed as part of a highway improvement project in the 1980's and was not replaced with a modern structure. However, the back wall was left in place, and the fill behind it was removed, resulting in a small but effective catchment dam, which is still currently in use. In 2014, the East Shed was removed and replaced with two three-lane bridges designed to allow avalanche debris to pass under the road (Jones et al., 2014; Wilbur and Stimberis, 2010).



Figure 6: The concrete East Shed was built along Lake Keechelus on I-90 on Snoqualmie Pass in 1950 and now since been removed. (Photo: Washington State Archives³)

³ Washington State Archives. <https://www.sos.wa.gov/archives/>

Design loads were unavailable for the historic snow sheds on Snoqualmie Pass. However, URS and Mears (2007) proposed a new snow shed structure in the East Shed area, and estimated static loads normal to the roof of the shed to be between 1000 and 1400 psf (48.9 - 69.4 kPa) and avalanche impact loads between 300 and 1450 psf (14.36 - 60.4 kPa) for the slide paths impacting the snow shed. Operational costs for the old snow shed were considered to be minimal, with periodic inspections undertaken on an as-needed basis. However, estimated operational and maintenance costs for the proposed snow shed were close to \$800,000 per year, and also required approximately \$1 million in initial set up costs, including support infrastructure (e.g. emergency response building and equipment). This proposed 6-lane snow shed was never built; the avalanche bridges constructed in 2014-2018 were built in its place. In addition to the avalanche bridges, and the forecasting and control program, there are multiple snow nets installed in start zones above unprotected sections of the highway to anchor snow and break up slabs in start zones. Further details for these snow sheds are presented in **Appendix A** and **Appendix D. Section 10 provides a more detailed case study description of this proposed snow shed, the process and final outcome.**

3.4 Wyoming

Within the state of Wyoming, the Wyoming Department of Transportation (WYDOT) has requested proposals for a snow shed on State Highway 22, Teton Pass. No other historical or current snow sheds were documented.

State Highway 22 climbs over Teton Pass west of Jackson. While the highway crosses multiple slide paths, nearly half of the avalanche exposure may be attributed to the Glory Bowl and Lower Twin slide paths (Mears and Newcomb, 1989). WYDOT attempted to build a suspension bridge over the Glory Bowl path (Crater Lake Bridge) in 1968 in order to allow avalanche debris to pass safely under the highway. However, the bridge was destroyed by a large avalanche shortly before its completion in January 1970 (Yount and Gorsage, 2016) (**Figure 7**).

Mears and Newcomb (1989) proposed two avalanche sheds to protect the highway from the Glory Bowl and Lower Twin Slide paths. These sheds were to be 280 ft (85 m) and 250 ft (76 m) long, respectively, and were designed for impact loads of up to 1700 psf (81.4 kPa) and static loads of 1100 psf (52.7 kPa). The two sheds would virtually eliminate the avalanche hazard for the two paths, and would reduce the avalanche risk by 49% for all of Teton Pass. The proposal also recommended an improved non-structural mitigation program which would include an avalanche forecasting program, two 105-mm recoilless rifles, hand charges, and helicopter control. They estimated the combined structural and active mitigation measures would eliminate 61% of the avalanche hazard for Teton Pass.

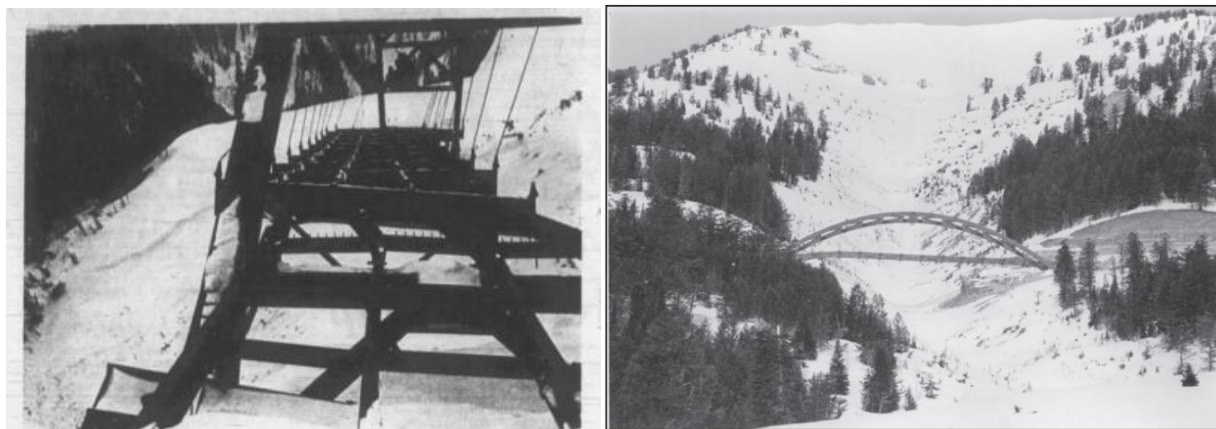

Figure 7: The Crater Lake Bridge over the Glory Bowl avalanche Path, Teton Pass (Photo: Jackson Hole Historical Society and Museum)⁴

In 1992, WYDOT conducted a feasibility study and concluded that the avalanche hazard could be adequately managed with short term active mitigation measures, including forecasting, a Gazex RACS system, a 105-mm Howitzer, hand charges, and an Avalanche Guard RACS. Ultimately, they decided that the additional \$17 million dollar expense (unit cost of approximately \$106,000/meter or \$32,000/ft) to install the two snow sheds could not be justified given their estimated 25-year design life, and the relative effectiveness of active mitigation (Wyoming Department of Transportation, 1992). It should be noted that the estimated 25-year design life is shorter than the design life used for most other snow sheds (e.g. Rogers Pass), which would typically have a design life of 50-75 years, or longer. Further details for these snow sheds are presented in **Appendix A** and **Appendix E**.

3.5 Alaska

Within the state of Alaska, the Alaska Department of Transportation and Public Facilities (AKDOT&PF) has requested proposals for a snow shed on the proposed Lynn Canal corridor. No other road based historical or current snow sheds were documented.

The Juneau Access Improvement project aimed to improve access along the Lynn Canal Corridor between the communities of Juneau, Haines, and Skagway. The project included improved roadways along the Lynn Canal that would cross 78 avalanche paths. AES and Mears (2004) investigated the avalanche hazard for the project, which was reviewed by Mears (2013). The studies proposed two snow sheds to protect three paths in the East Lynn Canal area, which

⁴ Jackson Hole Historical Society and Museum. <https://jacksonholehistory.org/wp-content/uploads/2012/03/Spring-2008-Chronicle.pdf>

would run for a combined 1500 ft (457 m), and reduce AHI along the East Lynn Canal by 57%. The sheds were proposed to be constructed of either reinforced concrete or by steel culverts, and would cost an estimated \$20 - \$30 million in 2013, equaling approximately \$22 - \$33 million in 2020 (unit cost of approximately \$48,000-\$72,000/meter or \$15,000-\$22,000/ft). The project was never executed due to state budget issues, and was officially shut down in July 2018 (AKDOT&PF, 2018). Further details for these snow sheds are presented in **Appendix A**.

3.6 Railroads in the USA

Alaska Railroads

Several wooden sheds were built along the Alaska Railroad between 1917 and 1943. Snow sheds were built at Kern path, Miles 43, 50, 76, as well as at least four additional sheds whose locations are unclear. However, by 1965 all of these sheds had been removed and there are currently no snow sheds protecting the railway. Hamre (2009) suggested constructing two new sheds for the Kern and Centerline avalanche paths near Girdwood. The two sheds would account for an additional 39% reduction in AHI, after implementing an active mitigation program and a catchment ditch for another avalanche path. The sheds would cost an estimated \$895,000 annually for their lifespan including construction and maintenance, when amortized (equal to \$1 million in 2020). Their construction costs alone were not presented. These sheds have not been built, and there are currently no snow sheds along the Alaskan Railroad. Further details for these snow sheds are presented in **Appendix A**.

Central Pacific Railroad, California

In the early 1900's, the Central Pacific Railroad (CPR) built 40 miles of wooden snow sheds along the portion of track crossing the Sierra Nevada over Donner Summit, California. The sheds made it possible to operate the trains year-round, and were put in place to deal with large snowfall amounts as well as avalanches. The wooden sheds were prone to structure fires started from the coal- and wood-fired locomotives, and were removed as snow removal technology improved. Today, there are still some sections of track protected from avalanche paths with concrete sheds (Donner Summit Historical Society, 2016). Due to a lack of data, a summary of these snow sheds is not presented in Appendix A.

Union Pacific, California

Two snow sheds are currently operated by Union Pacific Railway: the Cisco Butte snow shed, 1000 ft long (304 m); and the 47 Shed, 860 ft (260 m) long. Limited additional information was available for these snow sheds, but they are constructed with a concrete retaining wall, and heavy timbers for the roof structure, and a metal roof. These are the only remaining snow sheds along this line. Prior to the "The Big Hole" tunnel being constructed in 1993, which passes beneath Mt. Judah about a mile south of Donner Pass, there were long sections of snow shed on the eastern approach towards Donner Pass – which have now been abandoned. These were

previously owned by CPR and are documented above. Due to a lack of data, a summary of these snow sheds is not presented in Appendix A.

Great Northern Railroad, Washington

Beginning in 1910, the Great Northern Railroad began building snow sheds through the Cascade Range of Washington. The first structures were built of reinforced concrete, and subsequent construction between 1911 and 1914 used timber or a combination of timber and concrete. The combination structures were built assuming a static load of 400 psf (19 kPa). The railroad built a total of 17,588 ft (5360 m) of snow sheds between 1910 and 1914. Similar to the structures built on the CPR in California, these were built not only to protect from avalanches but also as a means of managing heavy snowfall amounts (“Tunnel and Snow sheds in the Cascades: Great Northern Railway,” 1914). Due to a lack of data, a summary of these snow sheds is not presented in Appendix A.

Burlington Northern Santa Fe Railway, Montana

Burlington Northern Santa Fe Railway (BNSF) have 10 current snow sheds, and 1 historical snow shed along the section near Glacier National Park in Montana (**Figure 8**). These snow sheds were originally built between 1912 and 1930, with additions in 1929, 1932, 1936 and 1957. These sheds range in length from 400 to 1360 ft (120 to 415 m). All of the sheds were built using concrete retaining walls on the uphill side of the rail grade. The remainder of the structures are framed using large wooden timbers over the two sets of railroad tracks - a double main line runs through all sheds. One snow shed, “Shed 4C”, also known as “Burn Out” was destroyed by fire in 1978, but the retaining wall is still present.

As part of an Environmental Impact Statement (EIS) one alternative option for avalanche mitigation proposed five new snow sheds, totaling approximately 3,540 feet (1079 m), to be constructed. Seven existing snow sheds would be extended approximately 1,500 feet (457 m), for a total 5,040 feet (1536 m) of snow sheds to be constructed (National Parks Service, 2008).

Early in the EIS process, BNSF estimated approximately \$7000 per linear foot (\$23,000/meter) to build a snow shed, and \$40,000 per year to maintain all of the existing 10 sheds (National Parks Service, 2008). This construction cost was adjusted upwards to approximately \$20,000 per liner foot (\$66,000 per lineal meter) based on 5006 ft / 1527 lineal meters with an estimated capital cost of \$100,782,000) by Hamre and Steiner (2006).

The risk reduction provided by the existing snow sheds has been only partially assessed. A mitigated AHI of 110 that takes into account the protection provided by 10 sheds for the John F Stevens Canyon Railroad corridor was calculated by Hamre and Overcast in 2004 (in National Parks Service, 2008). However a fully un-mitigated AHI for the railroad corridor has not been calculated, so a direct comparison for mitigated versus un-mitigated AHI and risk reduction is not possible. Further details for these snow sheds are presented in **Appendix A**.

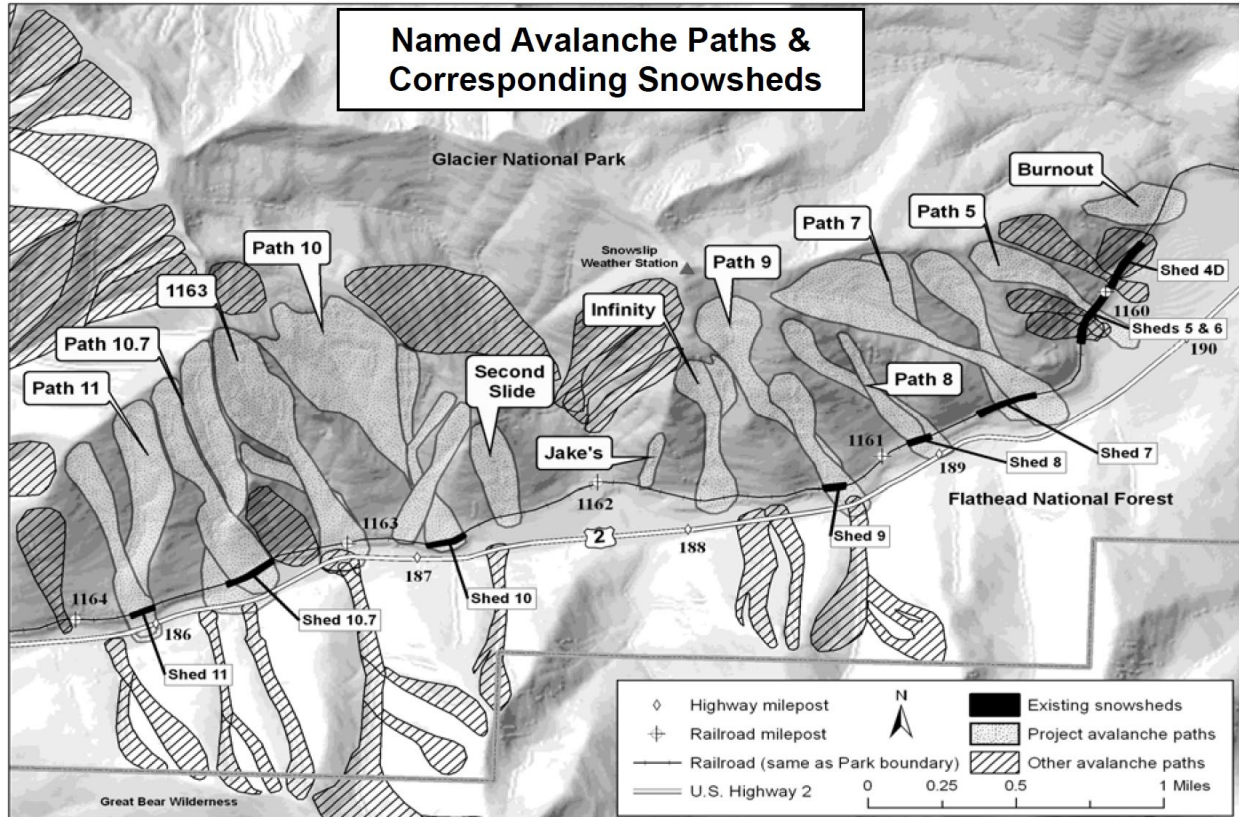

Figure 8: Named Avalanche Paths and corresponding Railway snow sheds (Hamre and Steiner, 2006)

3.7 Canada – Roads

Canada has nine avalanche snow sheds on public highways, eight of which protect the Trans-Canada Highway (Hwy 1) through the Columbia Mountains between Golden and Revelstoke, BC. The ninth Canadian highway snow shed is located on the Coquihalla Highway (Hwy 5) in the Cascade Mountains between Hope and Merritt, BC. Five of the Canadian highway snow sheds are managed by Parks Canada through Glacier National Park (GNP) and the remaining four sheds are managed by the British Columbia Ministry of Transportation and Infrastructure (BC MoTI).

Parks Canada, British Columbia

Parks Canada currently owns and maintains five snow sheds in Rogers Pass (GNP): Tupper Timber, Tupper #2, Tupper #1, Lens and Single Bench. These sheds have a combined length of approximately 1519 m (4984 ft). The first four of these snow sheds were initially constructed during the original highway construction between 1959 and 1962, but modifications were made to the original Pioneer and Tupper #1 sheds as late as 1966. The Single Bench snow shed was

constructed in 1978. **Section 9 provides a more detailed case study description of the Single Bench snow shed.**

ARMCO construction company won the contract to build the first snow shed (Pioneer, which was also called Sputnik 1), and chose to use metal culverts supplied in multiple steel plates (**Figure 9**). Unfortunately, the backfilling required to provide an even pressure distribution across the plates could not be completed by the first winter, and avalanches moved the structure out of position. The federal Department of Public Works lost confidence in metal designs and all subsequent snow sheds in Rogers Pass were made of concrete (Woods, 2014).

The original highway through Rogers Pass included six snow sheds because the Pioneer and Tupper #1 sheds were originally constructed as separate sheds. The original layout had approximately 30 m of uncovered highway between the two sheds which created problems for snow removal. The two sheds were joined in 1966 and, while the two parts feature different construction methods, they are now treated as a single snow shed with the common Tupper #1 name.

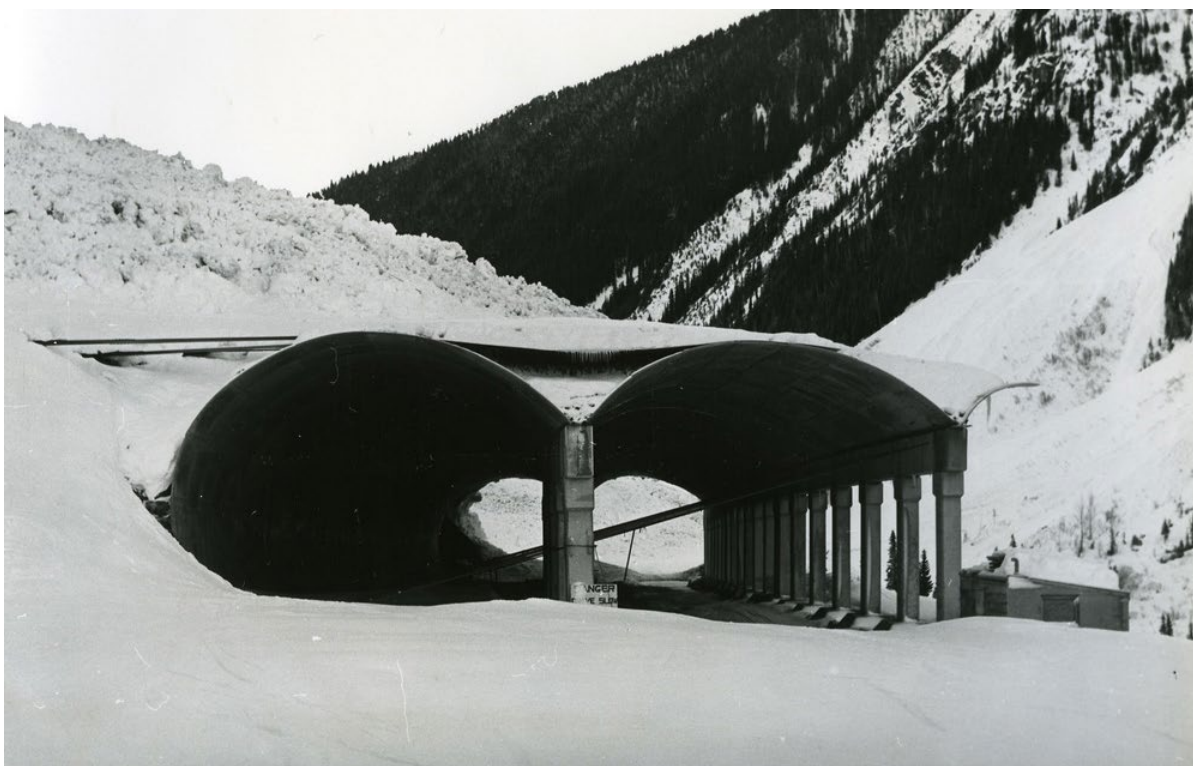

Figure 9: Pioneer snow shed built with multi-plate construction, 1961. This shed was joined with the Tupper #1 shed in 1966 (Photo: Peter Schaerer⁵).

⁵ Revelstoke Museum Photo Archive, 2020. <http://www.revelstokemuseum.ca/peter-schaerer-pictures/uub8fdplbhajy54tujz5rucp7t3zbx>

Other than the original Pioneer shed discussed above, the rest of the sheds in GNP utilized similar concrete construction methods. While design drawings were not readily available for all these snow sheds, the general construction methods are assumed to be same for all the sheds built in the same era. The Tupper #1 shed design includes a monolithic, cast-in-place steel-reinforced upslope gravity wall, cast-in-place concrete footings, pre-cast steel-reinforced concrete roof beams and columns, steel reinforced concrete roof slab, and pre-cast steel reinforced concrete parapet walls.

Four of the sheds have open downslope walls but use wood slats to reduce the potential for back spills. Single Bench is the one exception which has solid concrete wall panels on the downslope side due to the exposure to frequent avalanche impacts from the large Crossover avalanche path that is located on the opposite side of the valley. This downslope wall consists of pre-cast steel reinforced concrete panels installed between the structural columns.

The original shed contract values were provided by Parks Canada for the sheds, which ranged between CAD \$2875 per lineal meter (for the Lens extension and Tupper Timber) up to CAD \$4292 per lineal meter for Pioneer multi-plate structure. Adjusting these initial costs for inflation (accounting for significant changes in materials and labor costs since the 1960's), adding in estimates for lighting, traffic control, engineering, inspection and overhead, the equivalent costs in 2020 were estimated to be approximately CAD \$144,500/m for Pioneer, and \$101,000 to \$103,000/m for the remaining four concrete sheds. Although these contract values from the 1960's are mostly not relevant in current terms, the equivalent inflation adjusted amounts on the order of CAD \$100,000/m are in line with current unit (length) cost estimates for modern sheds in North America.

The original design avalanche impact load values were available for the Tupper #1, Pioneer and Single Bench snow sheds. Single Bench loads are discussed later in the case study (**Section 9**). Tupper #1 loads were re-evaluated by Dynamic Avalanche Consulting Ltd. in 2018 (Dynamic, 2018c), which provided 100-year normal loads of 50.2 kPa and parallel loads of 7.1 kPa. A horizontal static snow load against the downslope wall was estimated to be 8.1 kPa. For the Pioneer shed, the vertical deposit snow was originally estimated in the range of 14-33.5 kPa.

The five highway snow sheds have remained mostly unchanged since the completion of the Single Bench shed in 1978. However, as part of the Glacier National Park Avalanche Mitigation Project which occurred between 2015 and 2020, major rehabilitation work was completed on the Parks snow sheds which included drainage improvements on top and upslope of the sheds, debris removal from the shed roofs, column repairs (chipping, forming and upgrading of the concrete structures), and complete lighting upgrades to LED systems. This included approximately CAD \$9.2 million for column repairs and drainage upgrades, plus approximately CAD \$20 million for lighting upgrades, including construction of a power transmission line.

Further details for these snow sheds, including rehabilitation, operation and maintenance costs, and designs are presented in **Appendix A** and **Appendix F**.

BC MoTI

In addition to the five Parks Canada snow sheds on the Trans-Canada Highway through Rogers Pass, three snow sheds are located immediately west of the GNP western park boundary. These three sheds are owned and maintained by the BC MoTI: Lanark, Twin and Jack McDonald Snow Sheds (**Figure 10**).



Figure 10: Lanark snow shed built using prefabricated concrete, prior to construction of the wingwalls. Note the guiding berm on the left. (Photo: Peter Schaerer)⁶

The construction of the three sheds east of Revelstoke were completed by 1962 at the same time as the GNP sheds were completed and the TCH was opened between Golden and Revelstoke, BC. The three sheds are all steel reinforced concrete construction and generally all have open downslope walls consisting of wire mesh except for the eastern side of the Lanark shed which has solid concrete walls where the shed is exposed to impacts from the Laurie path on the opposite side of the valley (**Figure 10**, right side). The Lanark shed is the only shed with

⁶ Revelstoke Museum Photo Archive, 2020. <http://www.revelstokemuseum.ca/peter-schaerer-pictures/mpianjijq1chbl9b8lxdqodlnmbti9>

upslope guiding berms. The Twin sheds includes two downslope buttresses which are assumed to be part of the drainage structure.

Design drawings were not readily available for all three of the BC MoTI sheds but the construction generally appears to be the same for all three. The Lanark shed construction consists of a cantilever upslope retaining wall and cast-in-place concrete tieback anchors, concrete columns, and pre-stressed concrete beams, and steel reinforced concrete roof slabs.

While well-designed, and based on all of the information at the time, real-world experiences resulted in some unexpected challenges – examples include the 1 Jan 1963 avalanche event on Lanark snow shed that resulted in both portals / entrances being overtopped, trapping two cars and several people inside. This resulted in revisions to the snow shed design and in 1964. Tall concrete containment wing walls were added above both entrances of the Lanark shed (Woods, 2014). These wing walls were built using cantilevered methods so that the structure of the walls are independent from the shed structure, and the additional load from the walls does not affect the snow shed (**Figure 11**).



Figure 11: The cantilevered wing walls on the Lanark snow shed were constructed after the construction of the snow shed. The structures of the wing walls are independent from the shed structure and the additional load from the walls does not affect the snow shed (Photo: Alan Jones).

In 2019, the snow shed lighting was upgraded to LED in all three of the BC MoTI sheds east of Revelstoke. Light upgrading included installation of 576 LED lights and 18 new light poles at a cost of CAD \$7.15 million, which is approximately CAD \$11,085 per lineal meter of shed. This

system includes an intelligent system that automatically measures the ambient daytime lighting outside the snow sheds and mimics it inside the shed (BC MoTI, 2019a).

Canada's ninth and newest highway snow shed is the Great Bear shed located on the Coquihalla Highway (Hwy 5) between Merritt and Hope, B.C (Figure 12). The Great Bear shed was completed in 1986 for the opening of the new Coquihalla highway. This is the widest of the Canadian snow sheds having three driving lanes in each direction (all others are two-lane structures). The shed consists of all concrete construction and includes large wing walls over both shed portals.

The Great Bear shed also has the steepest road grade of the Canadian snow sheds at 8% and at 285 m in length is the third longest highway shed (behind Tupper #2 and Lanark). The steep grade and shed length coupled with the high traffic volume on the Coquihalla highway has resulted in numerous traffic accidents in and adjacent to the snow shed.

The Great Bear snow shed is very effective in terms of avalanche protection, and is not subject to overspills due to the high wing walls or backspills (BC MoTI, pers. comm. 2020). The issues with this shed relate primarily to the road geometry (i.e. steep grade and super elevation) and drainage issues resulting in icing at the portals and in the shed, and the resulting hazards to traffic.



Figure 12: Great Bear snow shed, Coquihalla Highway 5, British Columbia, Canada. Photo is looking eastwards, with steep (8%) grade requiring eastbound trucks to have chains, which increases wear on the roadway surface (and has exposed heat coils). Note the significant horizontal curve which results in super elevation of the highway grade (Photo: Ryan Buhler).

The shed was originally constructed with an electric heating system (coils) under the concrete road slab; however this system resulted in melting and freezing of water and icing problems, and was thus turned off after several winters of operation. Additionally, there were noted issues of truck chains and snow plow blades wearing down the concrete slab and exposing heating coils.

Original construction costs were not available for the Great Bear snow shed, but BC MOTI provided insight into rehabilitation costs that are anticipated to be needed in the next 10-20 years, which would be at approximately 45-55 years into its design life. These costs are anticipated to include LED lighting upgrades estimated at CAD \$2-3 million (\$7000-\$10,500 per lineal meter), upgrade of the waterproof membrane for subsurface drainage improvements (in the next 10-15 years, cost estimate not provided), and road resurfacing in the next ~20 years with a unit cost of \$750 per m², which is approximately CAD \$6.6 million for the design snow shed road surface area.

BC MoTI has recently considered removal of the Great Bear snow shed due to the associated operations and maintenance costs, accidents resulting from the highway geometry, and major rehabilitation costs that will be need in the next 10-20 years. BC MoTI has recorded 40 avalanche events as reaching the snow shed in the past 31 years, which is approximately 1 event annually. Removal of this shed would require consideration of the need for alternative hazard mitigation options (e.g. large catchment on an elevated roadway, bridge, Remote Avalanche Control System(s), helicopter control as is completed for the remainder of the avalanche paths that affect the highway) versus the ongoing costs associated with retaining the shed.

Four potential snow sheds were evaluated during 2005-2011 for construction for the Phase 4 Kicking Horse Canyon Project, located east of Golden, BC. All four sheds were to be constructed over all four highway lanes, and had design lengths of 90 m, 120 m, 10 m (tunnel portal canopy) and 350 m. All sheds were combined snow avalanche and rockfall protection structures designed for 300-yr return period avalanche events. Estimated 300-year design loads for these sheds were in the range of 17-64 kPa normal load and 10-25 kPa parallel load.

Three of the Kicking Horse Canyon shed designs included vertical stopping structures (catching nets) on the downslope edge to stop and contain avalanches on top of the shed, which provided protection for the CPR railroad located immediately downslope of the highway. Final design or construction was not completed for these sheds. Rather, the current project scheduled for construction starting in 2020 (currently in the tendering stage by BC MoTI) will include large catchments and attenuating structures (nets) to reduce the hazard to the highway. Further details for these snow sheds are presented in **Appendix A** and **Appendix G**.

3.8 Canada - Railroads

The history of railway snow sheds in Canada dates back to the late-1800s with the construction of the Canadian Pacific Railway (CPR) through Rogers Pass in the Columbia Mountains. There were originally 31 railway snow sheds built through Rogers Pass which were used until 1916 when the 8 km long Connaught railway tunnel was completed and most of the original snow sheds became obsolete.

The CPR line through Glacier National Park currently has three remaining operational snow sheds on the western side of the park (**Figure 13**). Two of these structures have been completely updated to concrete structures, while the third consists of steel posts with concrete girders and roof.



Figure 13: Snow shed in concrete at the Canadian Pacific Railway, built in 1960 (Photo: Schaerer, 1967)

Immediately west of GNP are two more CPR snow sheds through the Laurie path (Chris Stethem & Associates, 1991). These concrete structures were designed in 1991 within the track, and thus required steep roofs that would shed avalanche deposits. Design loads included 3.5 kPa for the weight of the avalanche flow, 1.4 kPa parallel (friction), weight of snow deposit prior to avalanche of 4 kPa, and dynamic (normal) load which was a function of the roof shed angle (which was unspecified).

Yoho National Park (YNP) also has one CPR snow shed to protect the railway through the runout zone of the Mt. Stephen avalanche path east of Field, BC. This snow shed is 140 m long, and is a tied-back, pre-cast reinforced concrete box structure which was built in 1987 (Buck et

al., 2006; Hungr, 1986). Concrete retaining walls were added at each portal to keep debris from spilling onto the track. It was designed to protect the railway from debris flows and icefall hazards as well as avalanches. Upslope guiding berms direct the avalanche flow over the snow shed (**Figure 14**).



Figure 14: Mt. Stephen snow shed in Yoho National Park, British Columbia, Canada. The shed protects the railway from avalanches, debris flows, and icefall hazards. Avalanches pass over the railway track and affect the highway (Photo: Ryan Buhler).

West of Revelstoke, BC, in the Three Valley Gap area are two CPR snow sheds which are constructed with concrete upslope retaining walls, wood structures and metal roofing (**Figure 15**). These are likely the only remaining wood-structure avalanche snow sheds in Canada. Further details for all of these snow sheds are presented in **Appendix A**.



Figure 15: Two wood structure snow sheds that protect the Canadian Pacific Railway at Three Valley Gap near Revelstoke, British Columbia, Canada. Avalanches flow across the shed onto the lake, currently frozen in this photograph (Photo: Alan Jones).

3.9 Canada – Industrial

While outside the scope of this report (and not included in Appendix A), in addition to these snow sheds that protect public roadways and the railway lines, we are aware of two snow sheds constructed for private companies on private roads. These two are described briefly here, as one includes the use of a multi-plate design. The two snow sheds are the Line Creek snow shed near Elk Valley, BC, for Teck Coal and the North Portal canopy for the Galore Creek Mine in Northwestern BC.

The Line Creek snow shed is a traditional three-sided, concrete structure protecting a haul road and conveyor system and is 72 m long. The design event for this snow shed was estimated to produce a normal load of 33 kPa and a parallel load of 6 kPa.

The Galore Creek Mine access road North Portal canopy is a multi-plate structure made up of bolted steel rings (89 rings in total) buried within an earth fill embankment (**Figure 16**) (Brox et al., 2008). This structure was installed in September-October, 2007. The ring structure comprises 6 individual arch segments. The thickness of the steel plates vary from 8 mm to 12 mm. A mechanically stabilized earth (MSE) head-wall is located at the canopy terminus. A steel portal house structure that incorporates a tunnel door is located at the canopy terminus. A

concrete box containing HDPE sleeve pipes was installed below the canopy subgrade. The total length is 68 m, and the structure was designed for loads up to 85 kPa from static snow loads and 55 kPa from dynamic avalanche loading. This portal was constructed to protect an access and haul road at a tunnel transition and, although it was constructed, the tunnel was not completed or used to date.



Figure 16: Installation of the multi-plate structure at Galore Creek Mine access road North Portal canopy after excavation and site preparation (left) and during completion of the backfilling (right). Photos: D. Brox.

4. Summary and international examples from other jurisdictions.

4.1 Overview and technical background

Snow sheds have been constructed in numerous countries around the World. In Switzerland, there are more than 350 protective galleries, including avalanche galleries and tunnel entrances that could be endangered by rockfalls and/or avalanches (Schellenberg, 2009). Similarly, there are around 106 avalanche protection galleries ‘*Skredoverbygg*’ in Norway constituting around 8.2 km in length (Statens vegvesen, 2015). In Europe, the technical assessment of defense structures in permanent technical avalanche control systems are based on the EuroCode construction engineering standards. The entire EuroCode (EC) standard system is made of ten areas (standard series). In general, a Eurocode standard consists of a European standard general document, which is designated with EN (e.g. EN 1992-1-1) and a national application document (NAD), in which each country may enter national definitions under specific items (Rudolf-Miklau et al., 2015).

Due to the fact that avalanches are not a national, but rather a regional to local issue, in the United States or Canada, American National Standards (ANSI) do not exist in relation to avalanche defense structures (Rudolf-Miklau et al., 2015). Construction must conform to general structure standards, for which there are national standards (e.g. International Code Council, 2018; National Building Code of Canada 2015). In the USA and Canada engineers rely on the experience and standards developed in Europe for best practices guidance for snow sheds, and in particular guidelines from Switzerland. The application of the Swiss guidelines is presented in **Section 6**.

With respect to snow sheds (or avalanche galleries as often termed in Europe), there is a differentiation between open and closed galleries (tunnels). Avalanches flow over the gallery roof, and depending on the terrain on the downside slope, and possibility of avalanche back spill, or avalanche deposit from the opposite side, the downhill side may need to be enclosed. Besides the actions from avalanches, there is also earth fill load, rockfall, and stresses from the road traffic (action) to be taken into account during the design. The minimum action combinations to be examined are shown in **Table 1**.

Rudolf-Miklau et al. (2015) note that the load-bearing capacity (STR and GEO ultimate limit states) must be proofed for the indicated action combinations. Indicative design situations must also be taken into account (DS2). All actions from avalanche snow in movement (friction, normal loads, and deviation loads), together constitute either leading or accompanying actions. When setting up the action combinations, leading and accompanying actions must be defined, and varied if required. Eurocode-compatible combination coefficients can be found in the Swiss Guideline for avalanche galleries, and will be discussed further in **Section 6**.

Table 1: Recommended action combinations (AC) for avalanche protection galleries for the limiting state of the payload (ULS) and usability (SLS) (From Rudolf-Miklau et al., 2015)

Design Situation	AC	Actions combined with another		
		Permanent action	Variable action	Extraordinary action
DS1	AC1	Deadweight Earth pressure		—
	AC2	Deadweight Earth pressure	Avalanche Pressure	—
DS2 ^{b)}	AC3	Deadweight Earth pressure	Avalanche Pressure	—
DS3	AC4	Deadweight Earth pressure	—	Extraordinary traffic loads ^{a)}
	AC5	Deadweight Earth pressure	—	Extraordinary avalanche pressure
	AC6	Deadweight Earth pressure		Earthquake
	AC7	Deadweight Earth pressure		Rock fall, rock slide

a) Action types and models acc. to EN 1991-2 and ÖNORM B 1991-2⁷.

b) Construction conditions or repair work.

Actions from the ordinary avalanche result (design event) are to be classified as variable. The increase of the earth pressure must only be taken into account for deposited snow (natural snowpack or deposited avalanche snow). Horizontal pressure within the deposited snow need not be taken into account, except when there is a static load exerted on the downslope wall by a large deposit that covers the snow shed.

An extraordinary avalanche event is an extremely rare (return period > design event) and statistically difficult to measure avalanche event with high intensity and great magnitude. For such an event to occur requires different, independent factors to occur simultaneously, which statistically is a low probability event. This event must be treated as an extraordinary action.

⁷ ÖNORM EN 1991-2 (2004) Eurocode 1 – Einwirkungen auf Tragwerke – Teil 2: Verkehrslasten auf Brücken. Ausgabe: 2004-08-01 (in German).

Using this approach, even during the catastrophic avalanche winter of 1999 in Switzerland, many avalanche prone roads and railways could be kept open due to the extensive network of avalanche galleries (**Figure 17**) (SLF, 2000).



Figure 17: The Gotthard Highway in February, 1999 (Photo: SLF, 2000)

4.2 International examples of snow shed designs

A variety of designs using a range of materials have been used for snow shed designs internationally. These include stone archways, pre-cast or cast-in-place reinforced concrete, precast concrete arches, timber frame, and corrugated metal pipe (CMP) designs. The following section will provide examples of some of these designs.

Stone Arch: A stone or rock arch is an older style of snow shed, which is generally no longer used. The snow shed on Splügenpass is an Alpine mountain pass of the Lepontine Alps is an example of a stone arch snow shed. The snow shed is located on the pass road that connects the Swiss, Grisonian Splügen to the north with the Italian Chiavenna. Since the opening of the San Bernardino road tunnel in 1967, the pass has lost its former importance, and is no longer kept open in winter. In 1843, a 312 m (1,024 ft) long avalanche gallery was designed and built, but today is out of use albeit largely preserved. This rock arch snow shed covered the lateral extent of the avalanche path, and included windows on the downslope side for lighting and ventilation. While no longer in use, this snow shed / gallery design is a good example of a stone arch, and provides the basis of subsequent snow shed designs throughout the Alps (**Figure 18**).

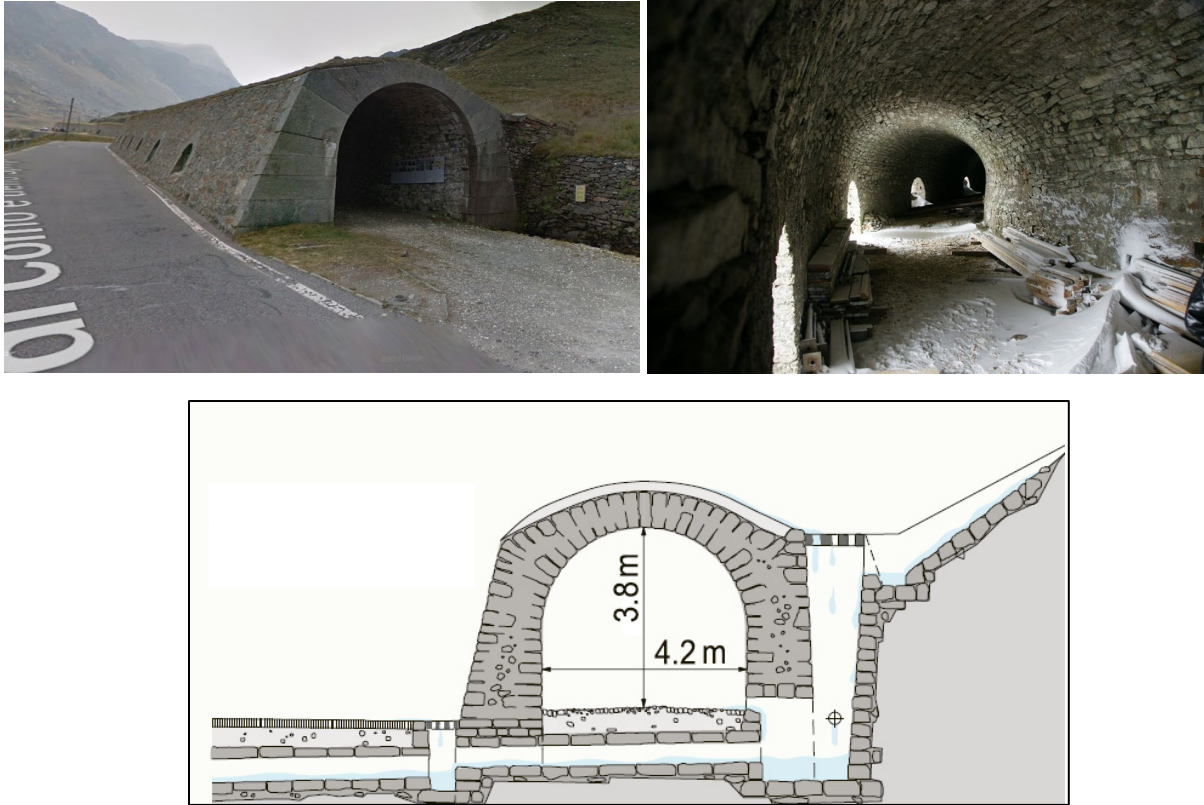

Figure 18: Snow arch snow shed on Splügenpass (constructed 1843 – 1846, length 312 m) as viewed from the outside (Photo: Google Earth, 2020⁸), the inside and the cross section (Photo and cross section: Denkmalpflege / Monument Preservation des Kantons Graubünden, Switzerland)

Pre-cast concrete: The pre-cast concrete snow shed in the Schöllenen Gorge is one of five snow sheds on the road between Göschenen and Andermatt, and is a good example of this style of snow shed design. The Schöllenen gorge is in the Swiss canton of Uri and provides access to the St. Gotthard Pass. This snow shed is approximately 700 m long and was constructed using prefabricated concrete elements, with a gently sloping roof, a solid uphill wall, and open downslope side with concrete support columns (**Figure 19**). The roof is also designed for rockfall loads, and has been the focus of recent attempts to resolve pragmatic rules for the estimation of both snow and rockfall loads (Platzer, 2008).

⁸ Google Maps, 2020. Strada Statale, Splügen, Grisons
<https://www.google.com/maps/@46.5108202,9.3259682,3a,75y,162.21h,87.65t/data=!3m6!1e1!3m4!1sIP1y5I3buKcc8WOMxaY9oQ!2e0!7!13312!8i6656>

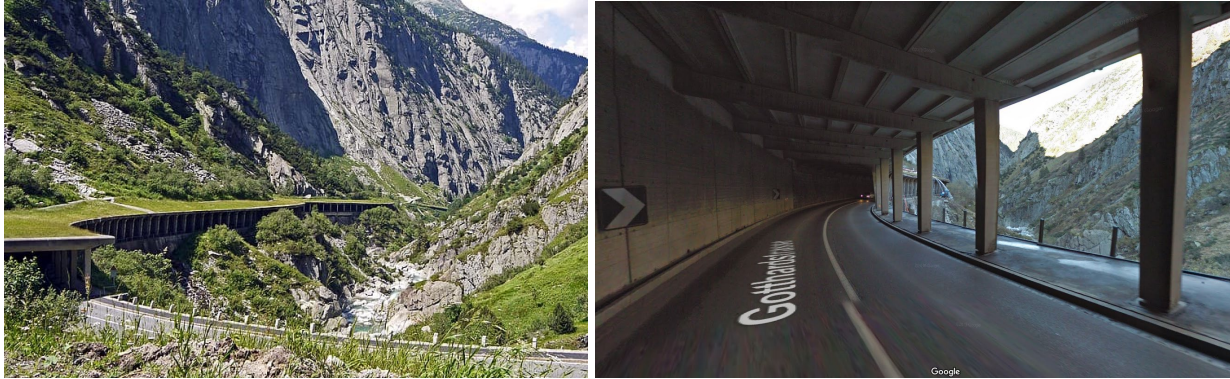

Figure 19: Prefabricated snow shed in the Schöllenen Gorge, as viewed from the outside (Photo: WF, 2020⁹) and inside (Photo: Google Maps, 2020¹⁰)

Monolithic concrete: The snow shed Val Raschitsch, Switzerland is a 130 m long, monolithic joint less structure that was constructed in 2002 and poured in-situ. This snow shed was constructed with a gently sloping roof into the slope, a solid uphill wall, and open downslope side with concrete support columns. The snow shed was then back filled and a low-incline sloping surface was created to reduce slope transition forces on the roof. In addition, this snow shed provides an example of the use of two guiding berms to provide protection to the portals, which reduces the risk of over spills at the portals (**Figure 20**).

A similar design (but without guiding berms) was used on the snow shed Salez in Davos, Switzerland. This snow shed was constructed alongside the Davosersee (Davos Lake), and protects the road from the well-studied Salezertobel avalanche path. According to Schweizer et al. (2008), on average, this avalanche path produces events that reach the road (or the roof of the snow shed) four times per winter. The snow shed was constructed in 1982 using cast-in-place methods, and is approximately 400 m long, with a gently sloping roof, a solid uphill wall, and open downslope side (**Figure 21**). This snow shed has no mechanical ventilation and only natural lighting. Two additional lanes are also present on the outside of the snow shed, which lead to a parking area approximately mid-way along the snow shed. This road and parking area is closed at times of high hazard.

⁹ WF, 2020. Switzerland roads. <https://www.wallpaperflare.com/switzerland-gotthard-schollenen-gorge-national-road-3-north-south-wallpaper-wmhvq>

¹⁰ Google Maps, 2020. Street view, Gotthardstrasse. <https://www.google.com/maps/@46.6499925,8.586006,3a,75y,343.27h,87.06t/data=!3m6!1e1!3m4!1sKEAxGwnAH3gD5dcNlhSTTW!2e0!7!13312!8i6656>

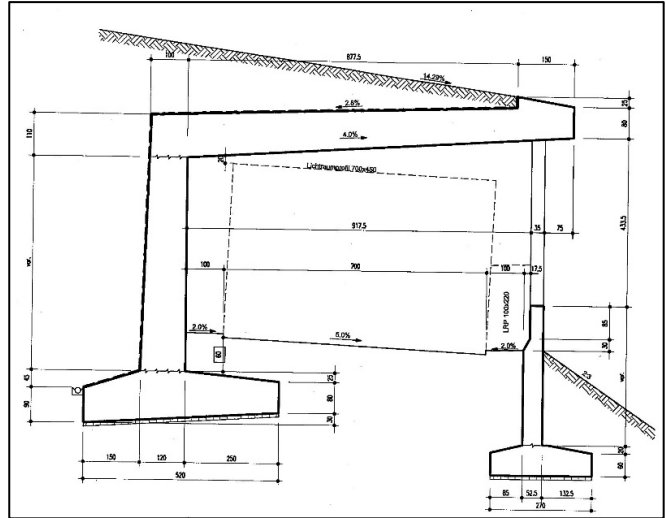

Figure 20: Monolithic Snow shed in Val Raschitsch as viewed from the outside on the side of the road, in profile showing the guiding berms, and the cross section (Photo from Tiefbauamt / Civil Engineering Office Graubünden, Switzerland)

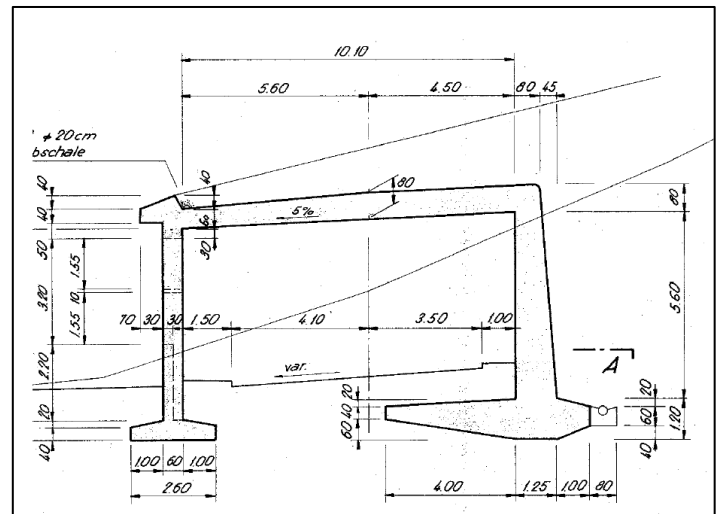

Figure 21: Snow shed Salez in Davos (constructed 1982, length 400 m) as viewed from the outside (Photo Google Earth, 2020), the inside and the cross section (from Tiefbauamt / Civil Engineering Office Graubünden, Switzerland)

it is recommended that these structures have at least 2.5 m depth of fill, and that the fill width is equal to the height of the structure (i.e. a fill ratio of 1H:1W). It is also critical that the entire structure is covered by fill, as a circular cross-section is weak in shear and should not be subjected to horizontal loads beyond the static earth fill pressures. Statens vegvesen (2014)¹³ suggests that it is therefore best to locate these structures in lower angled avalanche paths, or towards the end of the runout zone. If located within a stream channel, then the fill also needs to be resistant to erosion, and the structure should be sealed to prevent water entering the shed.

The snow sheds along the Fv91 road near Svensby, Lyngen, Norway are good examples of pre-cast concrete arch design, with similar 320 m and 160 m snow sheds located within 1 km of each other. The longer snow shed also has guiding berms to protect both portals (**Figure 23**). Neither of these two snow sheds have mechanical ventilation, but both have artificial lighting.

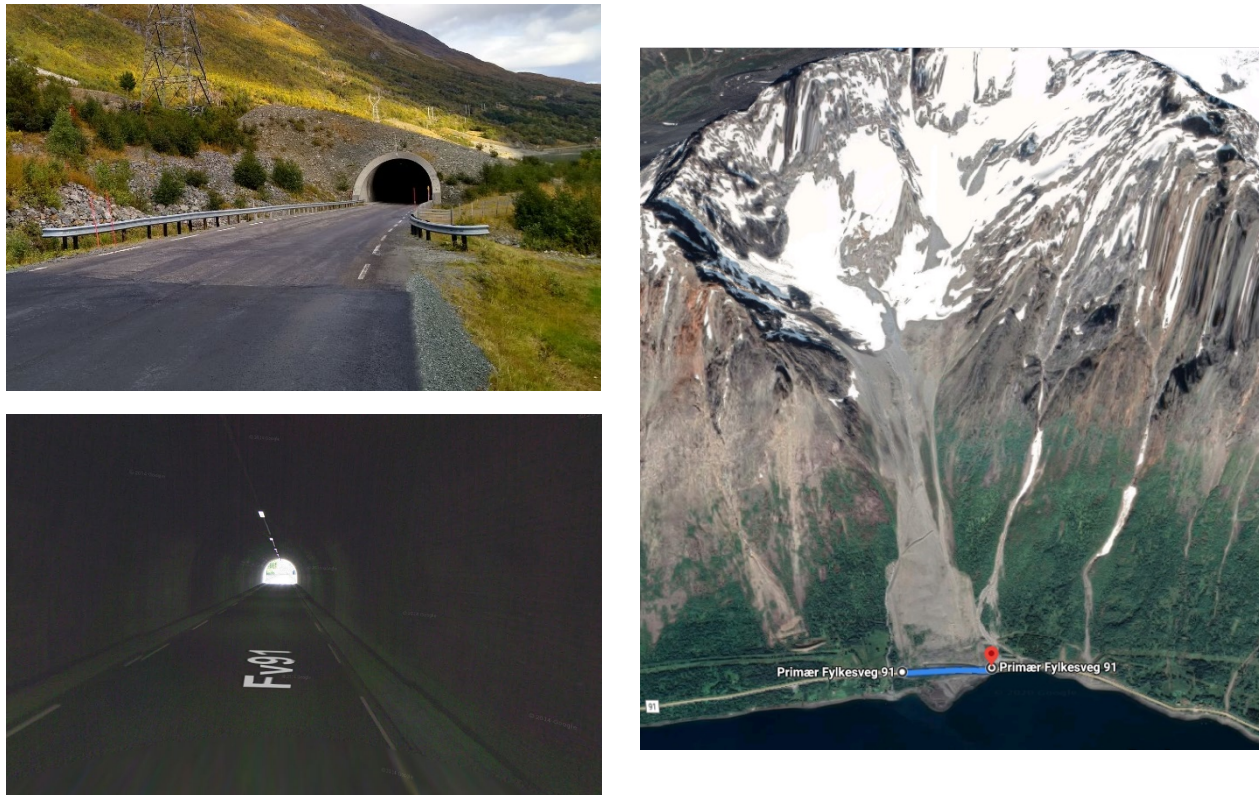

Figure 23: A snow shed near Svensby, Lyngen, Norway using a pre-cast concrete arch and backfill design. The guiding berm can be seen in the Google Earth Image Photo: Jordy Hendriks and Google Maps, 2020¹⁴

¹³ Statens vegvesen (Norwegian Public Roads Administration), 2014. Håndbok V138 - Veger og snøskred. In Norwegian

¹⁴ Google Maps, 2020. Street view, Fv91 Svensby. Lyngen, Norway.

<https://www.google.com/maps/@69.5887411,20.1034967,3a,75y,86.92h,90.69t/data=!3m6!1e1!3m4!1spNXm73CxbstnZT6CySaLq w!2e0!7!13312!8i6656>

Corrugated Metal Pipe (CMP) snow shed: While Corrugated Metal Pipe (CMP) is commonly used for culverts, stock under passes, and short sections of highway underpass, similar to the precast concrete arch snow sheds, Norway has been using CMP or '*korrugerte stålrør*' (in Norwegian) for avalanche defense since the 1980's. Like the concrete arch design, the backfill is a critical component of the overall structure, and needs to provide the strength for the distribution of the loads. These resulting structures are often termed soil-steel composite bridges (SSCB). The Statens vegvesen (Norwegian Public Roads Administration), 2014 guidelines for construction of SSCB support the use of CMP for avalanche protection, provided that the maximum longitudinal ground surface slope of 10% is extended to at least three times the span from the steel pipe/arch edge (i.e. require a low angled slopes above the structure, as a function of the structure width). This may in some cases increase the construction costs to undesirable limits, making the choice of SSCB in such cases less competitive to other conventional alternatives.

The 130 m long snow shed near Ellevoll in Troms, Norway¹⁵ and the 300 m snow shed near Olden, Vestland, Norway provide two examples of CMP snow sheds. The shorter snow shed protects the roadway from a single avalanche path, protecting the road for the expected width of this path (**Figure 24**). The longer snow shed covers the road for a number of unconfined avalanche paths, and the snow shed only covers the lane closest to the avalanche paths. This CMP snow shed replaced an older solid concrete snow shed, which also only covered one lane, but was approximately 100 m shorter in length. In both cases these roads are considered low-traffic roads by the Norwegian Public Roads Administration. Note that these two sheds use different arch designs, with the Ellevoll shed showing a high profile arch geometry, and the Olden shed showing a more circular geometry – Wadi et al. (2016) provide a good summary of the strength characteristics of different SSCB design geometries and their responses to external loads.

In another example, in Bjæring, Norway on County Road 452 in Nordland¹⁶ a CMP snow shed is used on a seasonal road, where non-winter traffic uses an higher risk road located above the snow shed, and is diverted to the lower, snow shed covered road in winter.

¹⁵ Google Maps, 2020. Fv868, Troms in Finnmark, Norway.
<https://www.google.com/maps/@69.3524115,19.9847327,3a,75y,251.79h,82.14t/data=!3m6!1e1!3m4!1s5QY63BCv3qjm3pCw159aLw!2e0!7i16384!8i8192>

¹⁶ Google Maps, 2020. Fv452, Bjæring in Nordland
<https://www.google.com/maps/@66.7602639,13.736839,3a,75y,277.13h,90t/data=!3m6!1e1!3m4!1sG8VdiR5Asv1RgomtgDC1AA!2e0!7i16384!8i8192>



Figure 24: A snow shed near Ellevoll, in Troms, Norway (left) and in Olden, Vestland as examples of a CMP snow shed design. Photo from Tore Humstad and Google Maps, 2020¹⁷.

Wadi et al. (2016) using 2D finite element models demonstrated that the proximity of avalanche deviation point has a great influence on the structural performance of these SSCB structures, and suggested that increasing the soil cover depth could help considerably in reducing the bending moments resulting from avalanches. While the work by Wadi et al. (2016) improves our understanding of SSCB structures and avalanche loads, they note that their findings are based on numerical simulations and it would be highly desirable to verify the results with full-scale experiments on real flexible avalanche protection structures with differing amounts of backfill, slope angles, and distance from the deviation point.

Other design considerations: While snow sheds are constructed with the primary purpose to protect the roadway from avalanches, and function rather than form dictates the design, there are cases where the design of the snow shed has been planned to be visually appealing. Examples of this are the snow and rock sheds near Hamnøy on the E10 in the Lofoten Islands, Norway¹⁸. These sheds were constructed as part of the Solbjørnneset-Hamnøy project and were nominated for the North Norwegian Architecture Award 2016, the National Association of Norwegian Architects (NAL) Architecture Award 2015, and received the European Concrete Award 2016 (Winther, I., 2017) (**Figure 25**).

¹⁷ Olden at county road 724 in Vestland.
<https://www.google.com/maps/@61.7516827,6.7939863,3a,75y,197.34h,88.87t/data=!3m6!1e1!3m4!1sSd79k-ai1Hv7BRT6YVZ0hQ!2e0!7i16384!8i8192>

¹⁸<https://www.google.com/maps/@67.9646788,13.1658961,3a,75y,269.49h,91.41t/data=!3m6!1e1!3m4!1sDk389KryYXMTklqkRovkOg!2e0!7i16384!8i8192>

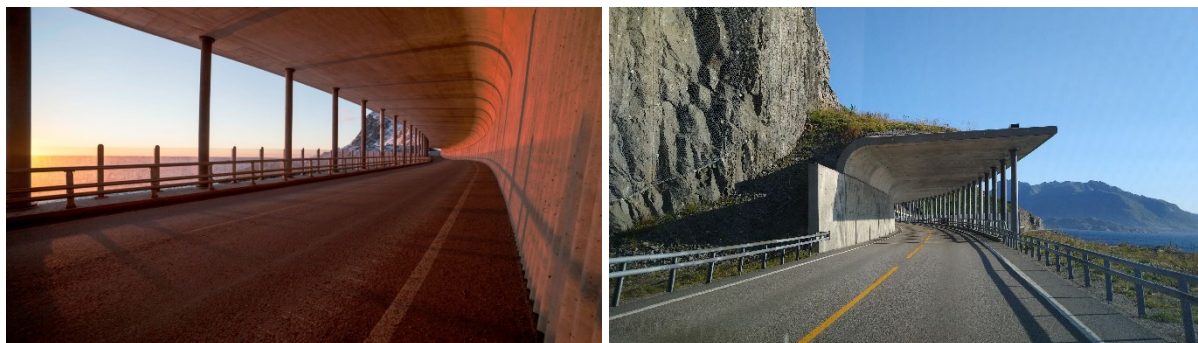

Figure 25: The snow sheds as part of the Solbjørnneset-Hamnøy project. Photo: Tommy Johannesen (Winther, I., 2017) left; and Photo: Jordy Hendrikx, right.

The following are translated quotes from Knut Hjeltnes, the architect for the project:

“Our goal has been to tone down the masses visually and emotionally, while at the same time feeling safe. And we have tried to use the situation, to drive along the sea. We wanted it to be open, giving people the feeling of being down in the shore and taking away the view as much as possible. The guide wall that faces the terrain is formulated with corrugated iron. It gives a light play and a kind of softness in the concrete. There are pedestrians and cyclists here as well, so it is important that the concrete feels soft when it is close to the body. We have tried to make it softer, softer and a little more playful than what a superstructure is often.”

And with respect to special design considerations:

“To open it to the view, we have done two things. One is that we use steel columns despite the fact that it is a concrete structure, which allows the columns to be made thinner. The second is that we have used a glass railing out to the sea, to prevent snow drift and the recurrence of rocks and snow in the roadway”

This project provides an example where the protection structure can both provide design level protection, but also integrate into the environmental context of the specific location.

In addition to structural design elements that enhance the visual appeal of snow sheds, artistic design elements can be used to enhance the aesthetics and blending in with the natural environment. For example, the Great Bear snow shed on the Coquihalla Highway, British Columbia, includes bear images in the textured concrete wingwalls which can be observed on both shed approaches (**Figure 26**). Some jurisdictions also require specific concrete color(s) or texturing that blends in with the natural environment and geology (e.g. Washington State DOT, Architectural Design Guidelines I-90 Snoqualmie Pass East, 2008). Landscaping can also be used to enhance the design, including the use of locally sourced rock and vegetation (**Figure 27**).



Figure 26: The Great Bear snow shed on the Coquihalla Highway 5, British Columbia, showing the addition of artwork in the concrete wing walls. Photo: R. Buhler.



Figure 27: Wildlife overpass on Highway 1 near Lake Louise, Alberta, showing the addition of architectural design elements to the entry, including stacked boulders, trees and vegetation. Similar design elements can be used for snow sheds to enhance the visual appeal and blending in with the natural environment. Photo: Google Maps, 2020.

4.3 Construction and Maintenance costs:

Construction costs for snow sheds vary by length, design, location, and jurisdiction. In general longer snow sheds will have higher total costs, but lower unit costs per length relative to shorter snow sheds. Likewise, solid concrete snow sheds are more expensive than timber or CMP snow sheds which use less (or lower cost) materials.

Direct comparisons of costs between international examples and the USA and Canada are problematic due to a wide variety of differences in final project costs, including material, labor and compliance costs. Accordingly, the costs presented in **Appendix A** and the most recent snow shed proposal as outlined in **Section 8** will provide the most accurate assessments of estimated construction costs.

However, from international examples we can infer some relative costs as a function of snow shed design. According to Wadi et al. (2016), the average estimated construction cost of a conventional concrete snow shed can range between 20,000 and 30,000 Euro per meter length (Föhn and Ammann, 1999; Schellenberg, 2009), or approximately US\$ 37,000 to US\$ 54,000 per meter, or approx. US\$11,300 per ft to US\$16,400 per ft (based on current exchange rates and accounting for inflation from 1999 to 2020). This comparison yields a lower cost per length than current and adjusted cost estimates from North American projects as shown in **Appendix A**. Part of this lower cost may be the much larger number of snow sheds that are installed in Europe compared to North America, which typically results in increased local expertise in design and construction, and resulting lower costs in competitive tenders.

With respect to overall design, The Norwegian Public Roads Administration (Statens vegvesen), (2014) note that, where conditions allow for the use of a culvert style snow shed (typically using CMP), that the price per meter of length is significantly lower than for traditional concrete structures. However, they also stress the requirement to ensure that the CMP is not subjected to heavy loads at their ends, and suggest that any snow shed using CMP should be a minimum of 5-10 m longer at each end than an equivalent concrete structure. As an example, for a 100 m long shed, this would result in an increased length (and thus relative cost) of 10-20% compared to the comparable concrete snow shed that has a greater tolerance for shed portal overfalls. Therefore, CMP snow sheds present the greatest cost efficiencies when considered over longer lengths. Vaslestad (1990), who examined only shorter drainage culverts (5-30 m), rather than longer avalanche protection structures found a 46% reduction in costs using CMP when compared to concrete culverts. Similar reductions in construction costs have been reported by Kjøniksen et al., 2018. Based on these assessments, and where the location is appropriate (i.e. sufficiently long shed and located in the runout zone, not in the avalanche path track), CMP snow sheds are likely to result in costs around 20-25% of comparable traditional concrete snow sheds with respect to their construction costs.

While construction costs should be carefully considered, so too should the lifetime maintenance, operational and compliance costs. The design of the snow shed can significantly

impact these, especially the operation and compliance costs if lighting, ventilation and emergency response (and egress) are required that are similar to tunnels.

Furthermore, after a snow shed is constructed they are exposed to rapid ageing and wear and tear due to the extreme environmental conditions (effects) and function, which results in a limited service life (Rudolf-Miklau et al., 2008). Mitigation structures can fulfil their protective functions over the entire scheduled life cycle only if they are regularly monitored and maintained during their use, or by the use of major rehabilitation measures in the latter stage of the structure design life. This is especially important for concrete structures that can be impacted from both environmental loads (e.g. snow and avalanches) as well as vehicle loads (e.g. from impact with structure).

Consideration should also be given to the natural environmental conditions and the potential interaction with the structure materials and reduction of design life. Construction of sheds near sea level needs consideration of potential corrosion of steel elements (e.g. multi-plate steel arch structures). Similarly, concrete sheds can deteriorate due to interaction with ground and surface water, so appropriate consideration needs to be given to the geochemistry of the local soil and water conditions. This is no different than bridge design, and building codes will provide appropriate guidance regarding these design elements.

Further details on design and operational considerations are presented in **Section 7**.

4.4 Damage:

Damage to the load-bearing construction of avalanche galleries is relatively rare (Rudolf-Miklau et al., 2008), but is to be expected over the lifetime of the structure. Damage can occur due to unforeseen or under-estimated effects such as vertical avalanche impact, rockfall impact, impact by vehicles, or as a result of suction forces. An example of this include an April 2009 wet snow avalanche that damaged the roof of the avalanche gallery Val Pischöt in Switzerland. This snow shed was built in the 1920's and the avalanche fell almost vertically onto the roof, resulting in a partial collapse (Rudolf-Miklau et al., 2008). Similarly, Conway et al., (2000) report an avalanche with an estimated impact pressure of 650 – 700 kPa (13,600 – 14,600 psf) that resulted in the collapse of the Eastern portal structure on the Milford Road in New Zealand (**Figure 28**).

Another documented example of damage from an avalanche is from the February 1999 avalanche cycle in Switzerland, where an avalanche generated suction forces that resulted in the removal of two glass elements on the downhill (valley) side of the snow shed on the Salezer Gallery in Davos, Switzerland (**Figure 21**). These glass elements were designed for a forces of 6 kPa (125 psf) (Rudolf-Miklau et al., 2008).



Figure 28: An avalanche on October 7, 1996 damaged the east portal of Homer tunnel. Impact pressures of 650-700 kPa were estimated, and resulted in damage to the reinforced-concrete portal structure (Conway et al., 2000).

Vehicular damage has also been documented, and while this can yield fatal results (e.g. Harrap, 2020), the structural damage is more commonly only surficial to the superstructure or supporting members, and does not result in the collapse of the snow shed. The most common damage to avalanche galleries is concrete spalling, corrosion of the reinforcement (especially when it's exposed due to loss of concrete due to spalling), water penetration or defective drainage systems. The waterproofing systems and the concrete cover for the reinforcement of older galleries typically do not meet the current state of technology with respect to drainage (Rudolf-Miklau et al., 2008).

5. Overview of relevant US federal and Canadian regulations for consideration

While the international examples presented in the previous section provide relevant and useful information, these need to be considered through the perspective of local, regional and federal regulations before they can be applied to a North American setting. The following section presents an overview of the relevant US federal regulations as they apply to snow sheds.

5.1 United States

The US Federal Highway Administration (FHWA) in its National Tunnel Inspection Standards (NTIS), defines a tunnel as:

“An enclosed roadway for motor vehicle traffic with vehicle access limited to portals, regardless of type of structure or method of construction, that requires, based on the owner’s determination, special design considerations to include lighting, ventilation, fire protection systems, and emergency egress capacity.”¹⁹

Consistent with that view, the National Fire Protection Association (NFPA, 2017) defines a road tunnel as:

“An enclosed roadway for motor vehicles with vehicle access that is limited to portals.”²⁰

This indicates that snow sheds should be considered as road tunnels with respect to their special design considerations. NFPA 502 is therefore the main reference for special design considerations for snow sheds. NFPA 502 requires a holistic, multidisciplinary engineering analysis of the fire protection and life safety requirements for a road tunnel regardless of the length of the tunnel.²¹

Therefore, if we consider snow sheds as road tunnels and that the requirements in NFPA 502 are applicable, we must consider at least the minimum requirements (provisions). These minimum requirements are classified as:

- (1) *“mandatory requirements”* which are prefaced with the word *shall*, meaning that they are the standards, and;
- (2) *“conditionally mandatory requirements”* which are requirements, but confirmation is based on the results of an engineering analysis.²²

¹⁹ Title 23, Code of Federal Regulations (CFR) Part 650, *Bridges, Structures, and Hydraulics*, Subpart E, *National Tunnel Inspection Standard*, Section 505, *Definitions*

²⁰ NFPA 502, *Standards for Road Tunnels and Other Limited Access Highways*, 2017 Edition

²¹ NFPA 502, Section 4.3.1

²² NFPA 502, Section 3.3.39

The minimum requirements based on tunnel length are as follows, where, underlining indicates the minimum provision for each length category:

Category X (L < 300 feet) – Where the tunnel length (L) is less than 300 feet, an engineering analysis shall be performed for fire protection and life safety requirements, an evaluation of the protection of structural elements shall be conducted, and traffic control systems shall be installed.

Category A (L ≥ 300 feet) – Where the tunnel length (L) is equal to or greater than 300 feet, an engineering analysis shall be performed for fire protection and life safety requirements, an evaluation of the protection of structural elements shall be conducted, and traffic control systems shall be installed. In addition, a water supply and standpipe system shall be installed.

Category B (L ≥ 800 feet) – Where the tunnel length (L) is equal to or greater than 800 feet and the maximum distance from any point within the tunnel to a point of safety exceeds 400 feet, all provisions of NFPA 502 shall apply unless noted otherwise.

Category C (L ≥ 1,000 feet) – Where the tunnel length (L) is equal to or greater than 1,000 feet, all provisions of NFPA 502 shall apply unless noted otherwise.

Category D (L ≥ 3,280 feet) – Where the tunnel length (L) is equal to or greater than 3,280 feet, all provisions of NFPA 502 shall apply.

A description of these minimum provisions of NFPA 502 is provided as follows:

- Protective measures (in addition to life safety) needed to prevent progressive structural collapse and mitigation of structural damage
- Traffic-control devices at the approaches to the snow sheds and within the snow sheds
- Fire-detection and alarm systems
- Two-way communications
- A water connection to local water infrastructure
- Dry pipeline and dry standpipes in the snow sheds
- Portable fire extinguishers
- Fixed water-based fire-fighting systems
- Tunnel drainage systems
- Means of egress
- Electrical systems and emergency power

However, according to NFPA 502, where a roadway is not fully enclosed, as would be the case for a three-sides open snow shed, the decision by the “authority having jurisdiction” to consider the roadway as a road tunnel shall be made after an engineering analysis is performed.²³

According to the Utah Department of Transportation²⁴, the term “authority having jurisdiction” is a broad term, since jurisdictions and approval agencies vary, as do their responsibilities. Where public safety is a primary consideration, the authority having jurisdiction might be a federal, state, local, or other regional department or individual; or others having statutory authority.²⁵

While in some cases snow sheds should be considered as road tunnels, FHWA provides owners with flexibility regarding whether to consider rockfall sheds, snow sheds, and other three-sided structures as highway tunnels as they relate to the inspection requirements in the National Tunnel Inspection Standards²⁶. Specifically, they state:

“Some structures, such as rock sheds and snow sheds, are built to protect the highway from falling debris. In addition, there are other three-sided structures that are similar to rock or snow sheds. If these structures do not align with the description and function of traditional highway tunnels (as described in point #1 of their memorandum) or other highway tunnels (as described in point #2 of their memorandum), they are not tunnels and the NTIS is not applicable to them even if they have lighting, ventilation, fire protection systems, or emergency egress capacity. However, the FHWA strongly encourages these assets be inspected at some regular interval in the interest of public safety. The inspections are eligible for Federal-aid funding under either the NHPP or the STP”²⁷

And they conclude in their guidance that:

“There are many unique structures and situations on our highways and all of them cannot be represented in this guidance. If there is a question on the proper classification of a structure as a tunnel, the Division office should work with its Bridge Safety Engineer and the State transportation department, federal agency, or tribal government to make a determination that is in accordance with the NTIS. However, when this guidance indicates that a structure does not meet the definition of a highway tunnel, the State transportation department, federal agency, or tribal government has the discretion to

²³ NFPA 502, Section 7.2.1

²⁴ Draft Snow Shed Concepts. Little Cottonwood Canyon Environmental Impact Statement S.R. 210 - Wasatch Boulevard to Alta. Utah Department of Transportation. May 11, 2020. https://littlecottonwoodeis.udot.utah.gov/wp-content/uploads/2020/06/LCC-EIS-Alternative-Screening-Report-2020-05-21_AppendixJ.pdf

²⁵ NFPA 502, Annex A, *Explanatory Material*, Section A3.2.2

²⁶ FHWA, Informational Memorandum, *Guidance on Structures Subject to the National Tunnel Inspection Standards*, October 2015. <https://www.fhwa.dot.gov/bridge/ntis/151027.pdf>

²⁷ FHWA, Informational Memorandum, *Guidance on Structures Subject to the National Tunnel Inspection Standards*, October 2015. <https://www.fhwa.dot.gov/bridge/ntis/151027.pdf>

classify the structures as a highway tunnel, inspect it according to the NTIS, and include it in the NTI”

In summary, the regulations for snow sheds in the USA remain somewhat variable, and are in part a function of the snow shed design, and the “authority having jurisdiction”. Therefore, it is recommended that any agencies proposing a snow shed should consult with their Bridge Safety Engineer and the State transportation department, federal agency, or tribal government to make a determination that is in accordance with the NTIS.

5.2 Canada

The two primary standards in Canada that are used by structural engineers for the design of snow sheds include the National Building Code of Canada (NBCC 2015) and the Canadian Highway Bridge Design Code (CHBDC) (CSA, 2019). The Transportation Association of Canada (TAC) publishes the Geometric Design Guide for Canadian Roads (TAC, 2017), which is the primary source for basic design principles for Canadian highways, including highway geometry.

In some jurisdictions (e.g. British Columbia), the provincial government supplements the federal government design documents with the preferred recommended practice for use on provincial transportation projects. For example, the BC Supplement to TAC Geometric Design Guide for Canadian Roads (BC MOTI, 2019) supplements the geometric design guidelines in TAC (2017), the BC Building Code (BCBC, 2018) supplements NBCC (2015) with provincial regulations specific to British Columbia, and The BC MOTI Bridge Standards and Procedures Manual (BC MOTI, 2016) is an older document (with updates in 2019) that provides a supplement to the CHBDC (CSA, 2019).

The National Building Code of Canada (NBCC 2015) is the basis for many local building codes in Canada, including the British Columbia (BC) Building Code. This code is based on principles of probability-based limit states design. Common values of the “reliability index” β as a measure of probability are in the range of 3.0 to 3.5 and higher for a 50 to 100 year design life, where β can be taken as the number of standard deviations that the safety margin exceeds zero, or that the safety factor exceeds one. The NBCC (2015) also provides provisions for seismic events with a return period of 2400 years, corresponding to a probability of exceedance of about 0.02 in 50 years.

The Canadian Highway Bridge Design Code (CHBDC) applies to the design, evaluation, and structural rehabilitation design of fixed and movable highway bridges in Canada. Snow sheds, being essentially bridge structures, are typically designed according to this design code. CHBDC and has set a target of β of 3.75 for a 75-year structure life for traffic and other live loads. The CHBDC provisions apply peak ground acceleration values that correspond to a 475-year return period event for seismic design provisions. Structural design of snow sheds in Canada should be performed using the Limit State Design approach of the CHBDC.

In accordance with Section 1.1.1 of the CHBDC (CSA, 2019), any structures subject to mountainous terrain effects (e.g. avalanches, rockfall) specifies that specialist(s) be retained to review and advise on the design and to ensure that the applicable requirements of other codes are met.

6. Snow and avalanche load considerations and methods

There are no explicit guidelines or regulations that can be applied to determine avalanche design loads on snow sheds in the USA or Canada.

In lieu of this, an avalanche expert is typically engaged, and an assessment of the snow and avalanche loads is undertaken. The resulting avalanche loads are then conveyed to the structural design engineer who determines how the loads will interact with the structure, and the corresponding structural response. Load (safety) factors are typically specified by the design structural engineers with consideration of the numerous other design loading considerations (e.g. dead loads, seismic loading, rockfall). While the assessment of snow and avalanche loads can be undertaken using a variety of approaches, the Swiss guidelines for snow sheds ASTRA/SBB (2007) are widely considered to be one of the leading approaches, and have been applied for the recent load consideration for the proposed snow sheds in Little Cottonwood Canyon, Utah (Dynamic, 2018a; 2018b; 2019) and for re-assessment of loads on snow sheds in Roger Pass, Canada (Dynamic 2018c).

We present a more detailed presentation of these methods below.

6.1 Swiss guidelines

The methods outlined in the Swiss guidelines for snow sheds ASTRA/SBB (2007) have been widely applied in Switzerland, USA and Canada for determining potential snow and avalanche loading on snow sheds. These guidelines are also well summarized in Margreth and Platzer (2008).

6.1.1 Design case

The Swiss guidelines define the normal **variable action** (30-year) and design **accidental action** (300-year) cases for determining loads acting on sheds. The equivalent of 300-year design loadings are typically used for design purposes. However, in practical terms, the 300-year avalanche is considered equivalent to the 100-year avalanche typically applied for design of avalanche protection structures in Canada. Probabilistic methods would need to be applied to provide a reasonable, scaled value for the 300-year event, but this is often beyond the scope of work for snow shed loading analysis. In this case, 100-year event loading may be applied combined with suitable safety or load factor(s) in the design.

The Swiss guidelines provide 8 load cases for typical actions on sheds resulting from snow and avalanches (**Table 2**); Cases 1 through 4 are generally the determining cases for most snow sheds. Case 8 is typically not considered due to site geometry, but would be evaluated for especially steep terrain such as the Milford Road in New Zealand where plunging avalanches can occur in some paths.

Typically, two types of avalanche events are considered for the design avalanche event for all cases:

- Dry, flowing avalanche. This event will have the highest speed and direct impact pressure on the roof of the structure (e.g. Case 1), but has lower overall densities.
- Wet, flowing avalanche. Will have lower speeds and thus is not considered as significant as a dry avalanche with respect to direct impacts. However, the mass of large, wet avalanche deposits need to be considered for Cases 3 and 4 since a large wet avalanche could stop on top of the shed, while a large, dry avalanche might continue flowing over the shed.

Table 2: Load cases to determine the actions induced by snow and avalanches. (Modified from ASTRA/SBB, 2007).

Case 1: Avalanche slides on structure without snow deposit (bare ground)	This situation could occur early in the winter when there is no snow at the corridor level. This is a potential design case as it results in highest shear forces on the roof of a structure.
Case 2: Avalanche slides on structure covered with snow	Similar to Case 1, however the weight of the natural snow cover has to be added. This is typically not a critical loading case since Case 3 (both natural snow and deposits) generally produces higher loads.
Case 3: Avalanche slides on structure covered with avalanche deposits	Involves an avalanche flowing over both snowfall (Case 2) and previous avalanche deposits. This is often a design case for many sites.
Case 4: Large avalanche deposit on structure	Includes the static mass of multiple avalanche deposits at rest, plus the weight of the natural snow cover. This is a possible design case at some sites.
Case 5: Static snow pressure on the outside wall of the shed	Essentially the same as Case 4 with the added static load of snow pressure on the outside wall of the snow shed.
Case 6: Dynamic avalanche pressure on the outside wall of snow shed	Involves a dynamic avalanche pressure on the outside wall of the shed, which only applies to paths that could be impacted from the opposite side of the valley
Case 7: Snow pressure on roof	Includes the weight multiple avalanche deposits, the in-situ snowpack and snow creep pressure on the roof. This is typically not a critical loading case at most sites.
Case 8: Avalanche impact on the roof of the snow shed	Loading by a plunging avalanche, which is not relevant at most sites, but can be given the local topography and location of the highway (e.g. Milford Road, New Zealand).

6.1.2 Reference section and geometric data

The Reference Section is defined in ASTRA/SBB (2007) as the slope section located immediately upslope of the shed where the depth and speed of the avalanche are defined (**Figure 29**). This section should be representative of the whole section up to and including the roof of the shed.

Ideally, snow sheds are located so that the deviation point is as far as possible upslope of the shed, a distance greater than 6 times the flow depth of the avalanche. Flow depth can vary significantly by path and avalanche characteristics, but typically has a range of 1 to 3 m for unconfined flow in a large avalanche path – which results in significantly increased deviation loads for 6 to 18 m downslope from the deviation point.

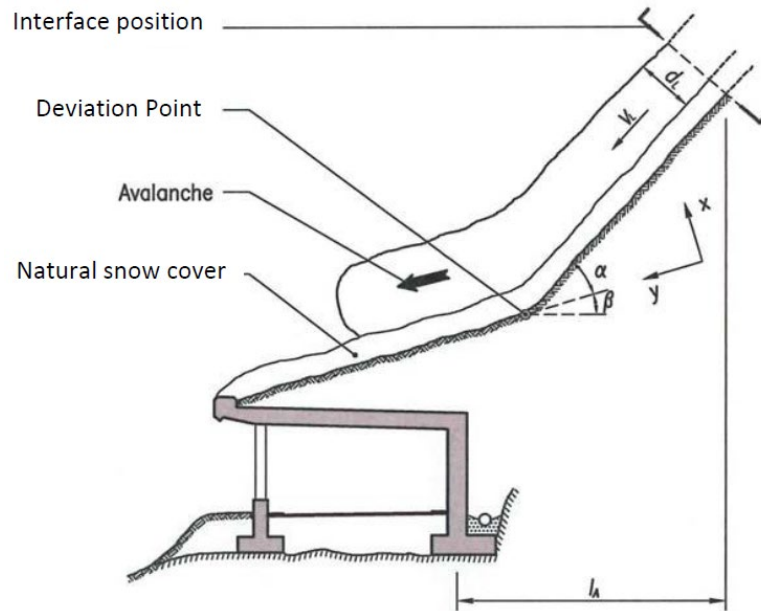

Figure 29: Geometric data and initial data for the interface position for flowing avalanches (modified from ASTRA/SBB, 2007)

The deviation angle (α) is the angle difference between the top of the shed and/or fill above the snow shed and the slope immediately above. This angle should be minimized to help reduced the deviation forces. This is typically achieved by having a sloping roof or by backfilling on top of the snow shed roof.

β is the slope of the shed roof (e.g. a level roof has $\beta = 0^\circ$). A flat roof reduces the amount of material required for the shed and shortens the width, but it also increases the normal (perpendicular) deviation forces which are proportional to $\cos \beta$. Other geometric data used for calculating forces on the shed are listed in **Table 3** (below) and shown in **Figure 29** (above).

Table 3: Geometric data for calculating forces on the shed.

Symbol	Units	Description
d_L	[m]	Flow depth of avalanche (determined from dynamic avalanche models)
v_L	[ms^{-1}]	Velocity of the avalanche (determined from dynamic avalanche models)
b_L	[m]	Flow width of avalanche (determined from the topography and field observations)
d_A	[m]	Total thickness of snow deposits (assumed based on site characteristics)
d_S	[m]	Depth of natural snow cover (determined from climate analysis)

Additional geometric variables include inclination and width of the starting zone and track, and the width of the shed, which are typically determined by analysis of topographic (e.g. LiDAR) data, field observations, and construction plans.

6.1.3 Evaluation of forces acting on structure

ASTRA/SBB (2007) provides a method for calculating the forces acting on a shed. The typical values for volumetric loads (density) and average friction coefficients depend on the terrain characteristics and expected avalanche flow characteristics. Avalanche flow densities and natural snow cover density used need to be adjusted for each specific location. For many intermountain and continental regions in the USA, values comparable to the 300-400 kg m⁻³ values as suggested in ASTRA/SBB (2007) are suitable for fully developed large avalanches in thick snowpack areas. Higher values may need to be used in maritime regions, and should be guided by observations of snowpack densities. Friction coefficients are typically assumed to be as described in ASTRA/SBB (2007) ($0.20 < \mu < 0.55$), but can vary depending on the site characteristics (**Table 4**).

Table 4: Specific weights and coefficients of friction for different types of snow and sliding surfaces (ASTRA/SBB, 2007)

Snow type	Specific weight (kN/m ³)	
Sliding dry snow avalanche	$\gamma_L = 3.0$	
Sliding wet snow avalanche	$\gamma_L = 4.5$	
Natural snow cover	$\gamma_S = 4.0$	
Avalanche deposit	$\gamma_A = 5.0$	
Sliding surface	Coefficient of friction μ	
	Dry snow avalanche	Wet snow avalanche
Snow cover	0.20	0.35
Smooth surface (e.g. concrete, grass)	0.25	0.45
Rough surface (e.g. scree)	0.35	0.55

Table 5 lists the formulae used for calculating the forces on structures for Case 2, applied perpendicular (normal) and parallel to the ground surface. Forces due to the snow cover (q_{nS} , q_{pS}) and avalanche deposits (q_{nA} , q_{pA}) are static loads, while those from the weight of the flowing avalanche (q_{nL} , q_{pL}) and deviation forces (q_{nU} , q_{pU}) are considered dynamic loads. The static and dynamic loads are presented separately.

Table 5: Forces acting on the top of a shed (Excerpted from ASTRA/SBB, 2007).

Action	Perpendicular to the ground surface	Parallel to the ground surface	
Natural snow cover	$q_{nS} = \gamma d_S \cos\beta$	$q_{pS} = q_{nS} \tan\beta$	[kN/m ²]
Avalanche deposits	$q_{nA} = \gamma d_A \cos\beta$	$q_{pA} = q_{nA} \tan\beta$	[kN/m ²]
Flowing avalanche	$q_{nL} = \gamma d_L \cos\beta$	$q_{pL} = \mu q_{nL}$	[kN/m ²]
Deviation forces (e.g. fig. 8.4)	$q_{nU} = \frac{\gamma \cdot d_L \cdot v_L^2 \cdot \sin\alpha}{6 \cdot d_L \cdot g}$ $g = 9,81 \text{ m/s}^2$	$q_{pU} = \mu q_{nU}$	[kN/m ²]

If required by the site and structure geometry, an increased deviation force of $4 q_{nU}$ may need to be assumed to act over a slope distance of $1.5 d_L$ from the deflection point. Deviation forces (q_{nU} and q_{pU}) will act over a slope distance $6d_L$ from the deflection point. Beyond this length the remaining forces include the natural snow cover (q_{nS} , q_{pS}), weight of avalanche deposits where applicable (q_{nA} , q_{pA}), and weight of the flowing avalanche (q_{nL} , q_{pL}).

The resulting transverse force distribution across the top of the top of the shed structure may include up to three transverse loading zones (**Figure 30**):

- Zone 1 (q_{nZ1} , q_{pZ1}) – Area with increased deviation force after the deflection point
- Zone 2 (q_{nZ2} , q_{pZ2}) – Deviation force zone
- Zone 3 (q_{nZ3} , q_{pZ3}) – Avalanche flow past deviation zone

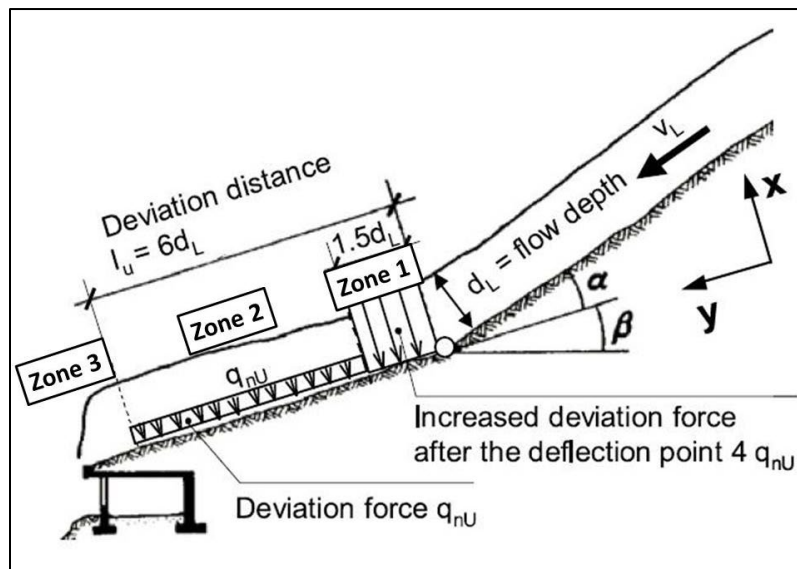

Figure 30: Deviation force zone and distribution of deviation forces (modified from ASTRA/SBB, 2007). When planning snow shed construction and design, construction in zone should be avoided if possible, as this is the area of the greatest deviation force and overall loads.

For many snow sheds, only Zone 2 (6d_L) and Zone 3 values need to be considered since many snow sheds have substantial low-angle backfill and up-slope colluvial fans, such that they are located well beyond the increased deviation force, Zone 1. However, sites with very steep terrain, or with sheds located higher in the path, may need to consider forces in Zone 1.

6.1.4 Effect of Rock and /or Trees in Flowing Avalanche

As most locations, there is a low likelihood that design rockfall and avalanche events will occur concurrently, partly because the most likely time for a design avalanche to occur is during the winter months (e.g. December through April in the Northern Hemisphere), which is typically the least likely time for a design rockfall event due to cold ground conditions. Thus, the combined probability of these two events will be lower than the probability of a single design avalanche or rockfall event. The Swiss guidelines simply state that for structures exposed to avalanches and rockfall, one does not consider these actions as simultaneous. Rockfall loads should be calculated separately, and this document does not provide guidance on these methods.

However, there is potential for rocks and trees to be entrained within a flowing avalanche, potentially increasing the peak loading at the structures because the densities of rocks and trees greatly exceed that of flowing snow. Estimating the potential effect of a rock and/or tree within a flowing avalanche is very difficult and typically not considered explicitly in loading estimates; this effect is normally accounted for in the structural design within a bulk load factor or factor of safety (FOS), or by increasing the input flow density (i.e. specific weight) to account for the uncertainty. Previous snow shed projects that the authors have been involved in have used a FOS in the range of 1.1 and 1.5.

6.2 Example loads

The resulting loads on the structure depend on the load cases as described above in Section 6.1, the design avalanche event, the snow climate, and the specific avalanche path and location of the snow shed relative to the path.

Margreth and Platzer (2008) present typical loads on snow sheds (total load due to avalanches and snow deposit) from SLF consulting reports in Switzerland (**Table 6**). These loads show a range of values, comparable to the design loads as presented in **Appendix A**, for North American snow sheds.

From **Table 6** it can be observed that 300-year Normal (q_n) loads can vary anywhere between 15 and 90 kN/m², while the corresponding Parallel (q_p , or shear) loads can vary between 3 and 20 kN/m². The Parallel loads are typically in the range of 10-25% of the corresponding Normal load, which is a function of the shed geometry and terrain located immediately upslope of the shed. These significant parallel loads also illustrate why full earth fill cover is needed for CMP/multi-plate structures, which are vulnerable to horizontal (shear) loading. Section 3.7

highlighted this effect for the Parks Canada Pioneer snow shed which was shifted out of position during the first winter of construction due to uneven backfill distribution across the plates.

Table 6: Typical loads on snow sheds (total load due to avalanches and snow deposit) from SLF consulting reports in Switzerland (Margreth and Platzer, 2008)

Location	Site characteristics, observations	Load case	Variable action (30 y.)		Accidental action (300 y.)	
			Normal q_n	Parallel q_p	Normal q_n	Parallel q_p
Val Chasté, Tschlin	Large avalanche, gully, return period 2 y., deposit height 7 m, no deflection.	3	43 kN/m ²	7 kN/m ²	73 kN/m ²	12 kN/m ²
		4	50 kN/m ²	7 kN/m ²	74 kN/m ²	11 kN/m ²
Taverna, Davos	Multiple avalanche events from both valley sides, no deflection.	3	38 kN/m ²	9 kN/m ²	60 kN/m ²	15 kN/m ²
		4	54 kN/m ²	12 kN/m ²	88 kN/m ²	20 kN/m ²
Camp, Vals	No multiple avalanche events, unconfined flow, 15° deflection.	2	11 kN/m ²	2 kN/m ²	23 kN/m ²	6 kN/m ²
		4	10 kN/m ²	2 kN/m ²	15 kN/m ²	3 kN/m ²
Seehorn, Davos	No multiple avalanche events, unconfined flow, no deflection.	2	11 kN/m ²	2 kN/m ²	15 kN/m ²	3 kN/m ²
		4	20 kN/m ²	4 kN/m ²	27 kN/m ²	5 kN/m ²
Val Ota, Susch	Small avalanche, steep track, deflection 20°, small avalanche deposit.	2	24 kN/m ²	5 kN/m ²	36 kN/m ²	8 kN/m ²
		4	15 kN/m ²	4 kN/m ²	24 kN/m ²	7 kN/m ²
Cozz, Mesocco	Small avalanche, deflection 20°, return period 10 y.	2	25 kN/m ²	3 kN/m ²	36 kN/m ²	5 kN/m ²
		4	30 kN/m ²	3 kN/m ²	40 kN/m ²	4 kN/m ²
Lant, Mesocco	Large avalanche, multiple avalanche events, canalized flow.	2	51 kN/m ²	7 kN/m ²	74 kN/m ²	9 kN/m ²
		4	50 kN/m ²	4 kN/m ²	80 kN/m ²	7 kN/m ²

7. Summary of design and operational issues associated with snow sheds

When applied effectively, snow sheds can offer some of the highest avalanche risk reduction of all the long-term mitigation options. However, in some applications, snow sheds have disadvantages and can increase the risk in other areas aspects of the highway design and performance, especially related to traffic flow and traffic accidents. Some of the issues presented below can be compounded, which can further increase the risk to the travelling public and the frequency of traffic accidents.

The Great Bear snow shed in British Columbia, Canada, is an example of a snow shed that is highly effective at reducing the avalanche risk to highway traffic essentially to zero, but which also has a well-documented history of vehicle accidents related to the presence of the snow shed and its associated design and operations issues. These issues include a steep grade, horizontal road curvature (and super elevation), lighting and icing issues. These problems are compounded with high vehicle speeds (75 mph / 120 km/h maximum), but also with slow moving trucks due to the steep grade, and relatively high traffic volumes. These issues have prompted BC MoTI to consider the removal of this snow shed, especially considering the upcoming rehabilitation work that will need to be completed in the upcoming 10-20 years as the shed approaches 45-50 years old.

The following section presents an overview of the key design and operational considerations. The majority of these examples are from British Columbia in Canada due to their relevance for North America, and long history of snow shed use.

7.1 Road grade

In applications where a snow shed is built on a steep road grade or adjacent to a steep road grade, a snow shed can create serious problems for traffic flow which result in serious and often fatal traffic accidents. The best example of this problem in North America is the Great Bear snow shed on the Coquihalla (Highway 5) in British Columbia, which has an average road grade of 8%. The posted speed limit on the Coquihalla is 120 km/hr (75 miles/hr) and the total length of the steep road grade extends roughly 5 km (3 miles) with the snow shed near the bottom of this hill. The snow shed results in some of traffic decelerating, especially large transport trucks, creating congestion while traffic in the other two lanes continues at full speed (commonly in excess of 120 km/h), resulting in multi-vehicle accidents at the portal and inside the snow shed. This has also resulted in fires in the shed, which creates an additional emergency response hazard with potential to damage the shed structure.

The steep road grade on the Great Bear snow shed has also resulted in additional wear on the concrete slabs due to eastbound trucks requiring chains; this has resulted in the need for resurfacing and issues with exposure of the heating coils beneath the grade slabs.

7.2 Road curvature (vertical and horizontal alignment)

Road curvature may create driving hazards and can occur in both the horizontal and vertical alignments. Curvature in both these directions cause a lack of direct sightline from the entrance of the shed to the exit of the shed. When drivers are unable to see the exit of the shed, this may affect their driving performance and cause issues related to rapid deceleration or drifting out of the driving lane which can both lead to accidents. This is especially compounded when lighting issues are present such as during a sunny day with a sharp transition from bright to dark when entering a shed. Modern, adjustable LED lighting systems can mitigate this issue.

Curvature in the horizontal direction can result in a loss of traction, especially if there is super-elevation on the outside of the curve, as is the case with the Great Bear shed and to a lesser extent with the Alberta snow shed on US 160 near Wolf Creek Pass. This loss of traction related to curvature and super-elevation is made substantially worse by the presence of icing. A common source of accidents in snow sheds occurs when transport trucks use their brakes on icy corners at or near the portal entry, and their trailers swing out across other driving lanes or impact the snow shed walls or columns.

7.3 Road width and traffic separation with barriers

The three BC MoTI snow sheds east of Revelstoke are notable because they are the only Canadian snow sheds without structural supports spanning the center of the sheds (**Figure 31**). In the other Canadian highway snow sheds, the center columns act as a meridian separating the opposing lanes of traffic. As a result, these narrow, 2-lane snow sheds have had a documented history of head-on vehicle collisions. The most notable event occurred in the Jack MacDonald snow shed in 2000 when a tour bus collided with a transport truck killing six and wounding at least 21²⁸.

Other highway snow sheds without a median barrier include the Wolf Creek Pass snow shed (3 lanes with no barriers) and Riverside snowshed in Colorado, and the (now removed) Snoqualmie Pass, Washington snow shed which was originally a 2-lane, 2-way shed that ultimately became two westbound lanes. Note that most of the European snow shed examples discussed earlier in this report do not have median barriers, so may be subject to similar road width and traffic accident issues.

The overall road width and inclusion of wide shoulders is an important consideration in modern snow sheds, many of which now need to include consideration of bicycle and/or pedestrian traffic. This is the case with proposed snow sheds in Little Cottonwood Canyon, Utah. The proposed design included a 4 ft wide (1.2 m) laneway separated from traffic by a concrete barrier which could provide pedestrian and/or bicycle access through the shed during the winter. A similar 4 ft (1.2 m) wide bicycle path was also proposed outside of the shed for non-

²⁸ CBC News, 2000. B.C. tour bus cleared just before accident. <https://www.cbc.ca/news/canada/b-c-tour-bus-cleared-just-before-accident-1.211417>

winter access. Many older sheds have no provision for bicycle or pedestrian access, which increases the public risk.



Figure 31: A 2018 accident involving three transport trucks occurred in one of narrow, undivided MoTI snow sheds east of Revelstoke (Photo: Global News, 2018)²⁹.

7.4 Snow shed height

Most of the Canadian highway snow sheds through GNP were built at a clearance height of 4.4 m (14'4"), except Single Bench which was built later at 4.9 m (16'1"). The three MoTI sheds east of Revelstoke are also all 4.4 m in the eastbound direction. According to the DriveBC Height Clearance Tool³⁰, these are the lowest unavoidable overhead hazards on the TransCanada Highway between Vancouver and Calgary (exceptions include overhead signs and overpass interchanges with on/off ramps that can be used for bypass). The standard height of a Canadian transport truck is 4.15 m so the majority of commercial vehicles are unaffected by the limited snow shed heights. While no recent examples of trucks or equipment making overhead impact with the snow shed portals, there is a well-documented history of oversized vehicles

²⁹ Global News, 2018. Trans-Canada reopened after crash east of Revelstoke; transports collide in tunnel <https://globalnews.ca/news/4757168/trans-canada-closed-east-of-revelstoke-transports-collide-in-tunnel/>

³⁰ DriveBC. 2020. Height Clearance Tool. <https://www.drivebc.ca/cvvp/index.html>

making overhead impacts with the snow sheds and the damage can still be observed in the Parks Canada Rogers Pass snow sheds (**Figure 32**). This height limitation should be carefully considered, especially in cases such as the proposed snow sheds in Little Cottonwood Canyon, Utah, where only one road provides access, and heavy equipment may be needed for future infrastructure of ski are development.

Parks Canada also reports that occasionally over height trucks impact the lighting inside the snow sheds, which requires replacement and increases maintenance costs. Given the cost of a single replacement LED lumiere can be approximately CAD \$2500 (in 2020), combined with inspection, repair labor and materials, and traffic control, these costs are significant and need to be considered in the annual operation and maintenance costs of the shed.



Figure 32: Overhead damage to the Tupper #1 snow shed has occurred where the original metal arch-shaped Pioneer shed joins the flat-roofed concrete Tupper #1 shed (Photo: Google Earth, 2020).

7.5 Lighting

Lighting, or a lack of lighting, can both create driving hazards depending on the time of day. Originally, most of the US and Canadian highway snow sheds lacked artificial lighting systems and relied on natural lighting through the downslope side of the sheds, which were either completely open or partially open with wooden slats or wire mesh. During the daytime, especially during sunny days, the transition from bright to dark when entering a shed causes a

driving hazard. The orientation of the snow shed can also increase the hazards related to daytime lighting when the snow shed portal is facing the south-to-west directions because during the afternoon periods the sun may be shining directly into the drivers eyes. This is notably a concern at the Great Bear shed where the portal is facing in the southwest direction in the downslope (westbound) driving lanes. The result is that traffic is travelling at high speeds down the 8% grade hill facing directly into the sun, which results in a period where drivers are unable to see into the snow shed for the brief period until their vehicle is completely inside the snow shed. This situation is credited for many multi-vehicle accidents.

Reportedly following the completion of lighting upgrades in Canada, the opposite situation occurred at night where the bright lights caused a sharp transition from dark to bright. As a result, dimmers were added to the lighting system to reduce the impact of the lights on drivers at night. However, this dimming system apparently was not working as designed, so BC MoTI removed approximately 50% of the lights to reduce the overall brightness in the shed. This highlights the importance of upgraded, modern LED systems with adjustable lighting systems to reduce the potential for vehicle accidents inside or at the shed portals. The Riverside snow shed and Alberta snow shed both have upgraded LED lighting designed to match ambient daylight conditions.

7.6 Icing

The temperature difference between the concrete in the shed and the asphalt outside the shed can result in road icing, especially when drainage control around the shed is inadequate or compromised due to lack of maintenance.

Icing can also occur when water enters the snow shed due to inadequate drainage control from backfill at the retaining wall. This can result when the membrane barrier is compromised, or due to build-up of sediment (clogging) of the drainage system over time.

Ice formation within or adjacent to the snow shed can result in a loss of vehicle traction and which can lead to traffic accidents. In March 2019, icing in the Great Bear snow shed led to a five-vehicle collision which sent two people to the hospital. The cause was reported as snow melting from the northbound lane (uphill direction) which drained into the southbound lane and refroze. The accident occurred when a passenger vehicle attempted to pass a slow-moving transport truck and lost control on the ice.

To address these potential icing problems, the Great Bear shed originally included a heated coil system underneath the concrete slab, but this system was only used for a couple years before it was discontinued. There were several issues associated with this system, including the melt and freeze cycles creating ponding of water and icy areas, as well as maintenance vehicles and trucks with chains wearing out the concrete surface and exposing the metal heating coils.



Figure 33: In March 2019, icing in the Great Bear snow shed lead to a five-vehicle collision which sent two people to the hospital (Photo: Global News, 2019)³¹.

7.7 Snow shed length/overspills

Inadequate snow shed length often results in avalanche overspills which can block the snow shed portals. In the USA, this has been documented to occur on the US550 Riverside snow shed in Colorado, which was only completed to the proposed Phase 1 length (out of three phases) and has many documented overspill events (see **Section 3.1** and **Figure 4**). In Canada, the Tupper #1 snow shed often experiences overspills on the eastern portal and as a result (**Figure 34**). Parks Canada (in consultation with COWI, McElhanney and Dynamic Avalanche Consulting) are currently (September, 2020) evaluating wing wall retrofit option that would prevent these overspills for avalanches with a 30-year return period. However, any new wing wall would need to be independently anchored separate from the snow shed, as it would be unable to withstand the additional design load. A wing wall was added to the BC MOTI Lanark shed shortly after construction following the 1963 avalanche event described below, but the wing walls had to be constructed as cantilevered structures so that they did not increase the loads on the shed (see **Section 3.7** and **Figure 11**).

³¹ Global News, 2019. 5-vehicle crash on the Coquihalla sends 2 to hospital Sunday .
afternoon<https://globalnews.ca/news/5043849/5-vehicle-crash-coquihalla-sunday/>

Avalanche overspills blocking a snow shed portal cause significant road closures for deposit removal and create serious risk to the travelling public related to traffic accidents. If both portals are blocked, such as the case with the Lanark snow shed in 1963 (**Section 3.7, Figure 10**), people can become trapped in the snow shed. This would also have the potential to cause ventilation and emergency egress problems in the case of a snow shed with solid downslope walls. In **Figure 34**, the large deposit was related to the overspill, while deposits observed on the photo left are related to snow drifting and plowing (see **Section 7.10**) and require periodic removal by loader, and temporary highway closures.



Figure 34: A 2007 overspill in the Tupper #1 snow shed completed blocked the shed portal and caused a lengthy road closure while the deposit was removed.(Photo: Parks Canada).

7.8 Back spills

Back spills are similar to overspills, but are where the avalanche debris enters the snow shed through the downslope wall rather than from above the portal entrance. This can occur on snow sheds with open downslope walls or with snow sheds that have wooden slats or wire mesh. The volume of snow which ends up on the road surface is generally less substantial than an overspill but can still create a hazard to the travelling public and cause road closures while the debris is removed.

Back spills are common in the GNP snow sheds which primarily have wooden slats on the downslope walls (all except for the Single Bench snow shed). Because most of the back spills are minor deposits, they are typically managed by passing snowplows without the need to close the highway to remove. The primary reasons for using wooden slats or wire mesh rather than completely closing the downslope walls is to prevent some of the back spill effects while still allowing natural ventilation and lighting.

7.9 Snow cornices and icefall

Snow shed portals can develop overhanging cornices and ice formations which have the potential to break off and fall onto the road surface and create traffic hazards. The preventative removal of these cornices or ice requires road closures and can result in a recurring maintenance cost for some snow sheds.

Cornices form when wind blows loose surface snow or snowfall over sharp transitions where it attaches and builds horizontally causing a buildup of dense overhanging snow. This is most common in wind-exposed mountain environments such as alpine ridgelines but can occur on snow sheds which are exposed to winds parallel to the roadway. Snow sheds with wing walls or parapet walls above the shed portals are generally less susceptible to cornice formation.

Margreth (2016) describes three scenarios where snow accumulation can fall off snow shed portals. The first is as described above where an overhanging mass of cohesive cornice snow fractures in a brittle or semi-brittle fashion. The second is where a narrow ledge or portal collar accumulates enough snow that it releases in a toppling-manner. This is described as occurring when the depth of the snow accumulation exceeds the width of the narrow ledge. The third scenario is when the snow fails in a sliding mode.

The height of the snow shed portal will determine whether or not mechanical removal of cornices or ice is feasible. Margreth (2016) describes some mitigation options, including maintenance personnel climbing on the portals and removing the snow with shovels, which can be dangerous and time consuming. They also propose installation of heating bands on the portal collars at critical locations, which could have associated problems (i.e. see **Section 7.6** above regarding heating resulting in icing problems), plus the ongoing operational cost of heating. Parks Canada uses a manual method for removal of cornices from the Rogers Pass snow sheds which involves using a crane truck with a Jersey Barrier (CRP), which is dragged along the upper portal edge (or along the parapet where present) to remove the cornice. This prevents having to expose workers on foot to avalanche hazards at the shed entry. This type of operation would be conducted on average four times per winter, which has associated highway closure times and costs.

7.10 Snow removal

Examples of snow removal related to avalanche debris on the road are presented above including overspills (**Section 7.7**) and back spills (**Section 7.8**) as well as cornice-fall removal (**Section 7.9**). In addition to these events, snow drifting into the sheds and snow removal around the portal entrances may be necessary (**Figure 34**). Similar to back spills, sheds with open or partially open downslope walls can be exposed to snow drifting from winds blowing loose snow into the shed, or wind may blow snow into the shed through the portal entrances (**Figure 35**). Also, cross-valley powder avalanches may drift snow into the shed at some locations (e.g. Single Bench shed in Rogers Pass, BC; proposed snow shed in Little Cottonwood Canyon, Utah).

A routine maintenance requirement related to snow removal and sheds is removal of plowed snow accumulation adjacent to the snow shed portals. This snow accumulation results from snowplows as they transition from the open road surface into the sheds. This snow accumulation has the potential to narrow the driving lane and to block signage, lighting or other shed infrastructure.



Figure 35: Two snow shed maintenance issues: (1) overhanging cornice snow and (2) snow accumulation at the portal (Photo: Alan Jones)

7.11 Structural damage to snow sheds

While damage to the loading-bearing structure of snow sheds due to impacts is rare, damage can occur which is typically related to avalanche impacts, rockfall impacts (e.g. **Figure 28, Section 4.4**) or vehicle impacts (Rudolf-Miklau, 2015).

The most common types of structural damage include concrete spalling, corrosion of the reinforcement, water penetration and defective drainage systems. These are typically caused by high chloride concentrations from the use of road salt, leaking dilation joints or defective seals. The waterproofing systems and the concrete cover of the reinforcement of older snow sheds may not be adequate and may require updating to current technologies (**Figure 36**).



Figure 36: Single Bench snow shed in Rogers Pass, BC showing evidence of debris and rockfall impacts on the concrete roof slabs (Photo: Dynamic Avalanche Consulting)

Over time, debris and vegetation can accumulate on top of snow sheds, which requires periodic maintenance. If not completed, this can result in additional static loading (dead load) on the shed that may not have been accounted for in the design, reduce the effectiveness of drainage systems, and can result in deflection of avalanches (or additional debris or rockfall deposits) towards the portal(s) (**Figure 37**).



Figure 37: Debris and vegetation accumulation on top of the combined Tupper #1 (right) and Pioneer (left) snow sheds observed in 2017. A major shed rehabilitation program by Parks Canada has removed this debris and improved the management of surface and subsurface water (Photo: Dynamic Avalanche Consulting).

8. Case study One: Proposed snow shed, Little Cottonwood Canyon, Utah, USA.

To better illustrate a number of the topics covered in **Sections 2** through to **Section 7**, we have prepared three case studies. The purpose of these case studies is to present examples and a synthesis for a range of scenarios. This first case study provides an example of a proposed snow shed in Little Cottonwood Canyon, Utah.

Location:

State Route 210 (SR-210) in Little Cottonwood Canyon (LCC), Utah, USA.

Timeframe:

Proposed. 2018 onwards.

Purpose & Motivation:

The Utah Department of Transportation (UDOT) began an Environmental Impact Statement (EIS) in the spring of 2018 for Little Cottonwood Canyon (State Route 210 (SR-210)), and Wasatch Boulevard in partnership with Utah Transit Authority and the USDA Forest Service to provide an integrated transportation system that improves the reliability, mobility, and safety for residents, visitors, and commuters who use SR-210. The EIS process aims to “...*deliver transportation options that meet the needs of the community while preserving the value of the Wasatch Mountains*”³².

UDOT were assisted in the development of the EIS by HDR Engineering (HDR) and Dynamic Avalanche Consulting Ltd (Dynamic) was retained to provide snow avalanche services to HDR as part of the EIS process. This EIS considers improvements to the SR-210 corridor from Milepost (MP) 0.0 to MP 12.5, and the SR-210 Bypass Road from MP 12.5 to MP 13.6. This corridor is affected by numerous high frequency avalanche paths that are monitored and controlled by UDOT using a combination of temporary road closures and explosive avalanche control by artillery, RACS and helicopter control methods.

Dynamic prepared a report for HDR that included an assessment of the Avalanche Hazard Index (AHI) method, which was evaluated for a wider range of scenarios, both for current (2018) and future 2050 traffic volumes (Dynamic, 2018a; 2018b). The AHI was used to evaluate the effectiveness of the proposed improvement options in reducing avalanche risk. These options included snow sheds as one of the potential options.

Location and design criteria:

The analysis by Dynamic built upon previous analyses along this corridor (e.g. F&P, 2006), which indicated that the baseline avalanche hazard conditions for LCC were extremely high (as

³² Utah Department of Transportation (UDOT), 2019. Little Cottonwood Canyon, Environmental Impact Statement. <https://littlecottonwoodeis.udot.utah.gov/>

quantified with the AHI), and remain high under the current controlled conditions, i.e. the residual avalanche risk. This high level of avalanche hazard reflects both the seriousness of the avalanche setting, the number and size of the paths, the lack of safe waiting zones between paths, as well as the high traffic volume.

Long-term measures are needed to further reduce the residual hazard unless a greater number of closures can be tolerated for additional and expanded active mitigation efforts, or the number of vehicles using the road can be substantially reduced. Using the AHI methodology, Dynamic (2018a) identified the most critical avalanche paths with respect to the theoretical uncontrolled, observed road events, and residual avalanche risk. They include: White Pine, Little Pine, and White Pine Chutes 1-4, and recommended that these paths should be the highest priority for passive long-term mitigation. This recommendation was consistent with both Schaerer (1999) and F&P (2006) who recommended varying lengths of snow sheds at these locations.

F&P (2006) and Schaerer (1999) proposed a total of 2485 ft (757 m) for the three snow sheds in the White Pine Chutes 1-3, White Pine and Little Pine avalanche paths. These proposed snow sheds would not mitigate the hazard on White Pine Chutes 4. All of these paths are located near MP 9, just below the White Pines trail head parking area, in the lower canyon. Dynamic (2018b; 2019) used a combination of field-based investigations, historical observations, and RAMMS avalanche modelling, and proposed slightly shorter total snow shed length of 2465 ft (751 m), including mitigation of White Pine Chutes 4. They achieved this with the proposed addition of guiding berms for White Pine and Little Pine paths, which shortens the overall length of the required snow shed and reduces the likelihood of over spills at the portals.

Without guiding berms in place Dynamic (2019) proposed that the snow sheds would need to be longer to reduce the likelihood of overtopping the snow shed entrances. They recommended a total increase of 500 ft (152 m), with White Pine increasing from 640 ft to 835 ft (195 m to 255 m) (195 ft / 60 m increase), and Little Pine increasing from 465 ft to 770 ft (142 m to 235 m) (305 ft / 93 m increase) (**Figure 38**). No change was proposed in the length for the White Pine Chutes 1-4 snow shed because guiding berms were not previously recommended, but did recommend a 10 ft (3 m) parapet wall be included on the western end of this snow shed to prevent avalanche snow entering the western portal.

UDOT and HDR further refined the potential location of the snow sheds by considering the options presented by Dynamic (2019) including and excluding berms, and added a third potential option which proposed minor roadway re-alignment and no deflection berms (Utah Department of Transportation, 2019). They also proposed the elimination of the approximately 200 ft gap between the White Pine and White Pine Chutes snow sheds, to create one, longer and continuous snow shed through these avalanche paths.

Given the traffic volume and projected increases, the snow sheds are proposed for a wider 3-lane roadway (the current roadway is 2-lane), with the central lane providing the option for bi-

directional traffic flow as a function of demand (**Figure 39**) (i.e. alternating traffic flow directions during the morning and afternoon peak traffic flow periods).

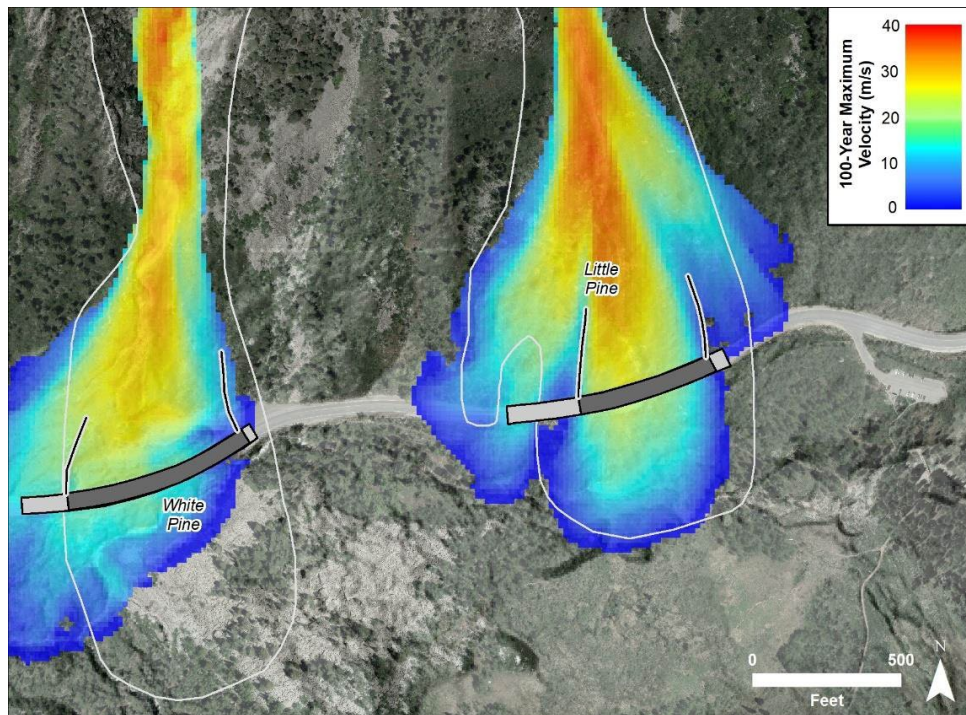

Figure 38: Little Pine RAMMS 100-year velocity (m/s), proposed snow shed with guiding berms (dark grey) and length without guiding berms (light grey) (Dynamic, 2019).

Dynamic (2018b) used the Swiss guidelines for snow sheds ASTRA/SBB (2007) to estimate the 100-year normal and parallel loads, which are considered equivalent to the 300-year loads with consideration of safety/load factor(s). The design case was determined to be Case 3, where a large avalanche (10 ft / 3 m flow depth) flows over existing snow cover (15 ft / 4.5 m depth), combined with previous avalanche deposits (13ft / 4 m depth). In addition to the design case, they also determined that if the snow shed were completely covered by seasonal snow and avalanche debris without snow management, a passive snow load (Case 5) to the exterior (downhill) wall of the snow sheds should be expected for White Pine and Little Pine, and a dynamic load (Case 6) from the adjacent side of the valley from the avalanche path Scotty's Bowl for Little Pine should be expected. The resultant normal loads were between 790 and 697 psf (37.7 - 33.4 kPa), and the resultant Parallel loads were between 116 to 105 psf (5.6 kPa – 5.0 kPa). Passive loads were 118 psf (5.6 kPa), and the dynamic load on the outside wall on Little Pine was 188 psf (9.0 kPa). These loads are similar to the typical range of design loads described in **Table 6** (in **Section 6.2**) for several Swiss snow sheds.

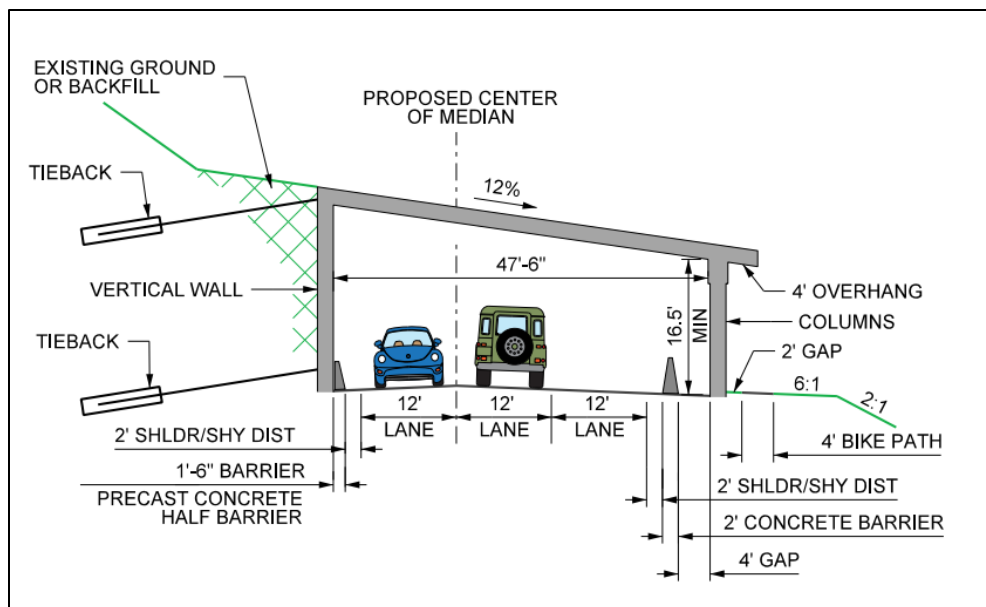

Figure 39: Proposed 3-lane snow shed cross section for SR-210 (UDOT, 2019)³³

Risk and residual risk

Dynamic (2018b) estimated the potential reduction in AHI and residual AHI if the snow sheds were constructed along this corridor. They compared the 2018 AHI and residual AHI (i.e. the current situation) to the project 2050's AHI and residual AHI with both 2-lane and 3-lane snow sheds. Winter time average traffic is projected to increase by 38% from 8,200 vehicle per day to 11,300 vehicle per day.

For a 2-lane snow shed, they estimated that it would provide a 41% reduction in AHI and 52% reduction in residual AHI for estimated 2050 traffic volume of 11,300 vehicles per day relative to the 2018 AHI and residual AHI without snow sheds (Dynamic, 2018b). For a 3-lane snow shed, they estimated that it would provide a 24% reduction in AHI and 34% reduction in residual AHI for estimated 2050 traffic volume of 11,300 vehicles per day relative to the 2018 AHI and residual AHI without snow sheds (Dynamic, 2018b). These estimates represent reduction in avalanche hazard for the entire road corridor, and not just these specific paths. The individual paths with snow sheds would be expected to have a reduction in avalanche hazard of approximately 90-100%.

The impact of adding an extra lane (i.e. 2-lane vs 3-lane snow shed) is that the length of the potential line of vehicles waiting due to an avalanche on the road is reduced, as it is spread

³³ Utah Department of Transportation (UDOT), 2019. Little Cottonwood Canyon, Environmental Impact Statement. Avalanche Mitigation Alternatives. https://littlecottonwoodeis.udot.utah.gov/https://littlecottonwoodeis.udot.utah.gov/wp-content/uploads/2020/05/10265_3_LCC_Public_Factsheets_Avalanche_Mitigation_FIN_WEB.pdf

across three lanes instead of two. However, the number of exposed vehicles that are waiting, per length of road, has also increased. Despite this, it is clear that by increasing the capacity of the road way, the waiting traffic component is changed, and that the residual AHI decrease for 3-lane snow sheds is less than with 2-lanes, even after the addition of the three snow sheds.

However, a wider 3-lane roadway would allow more room for turning around vehicles, which may reduce the waiting time (the analysis used a baseline of 1 hour) for clearing of traffic from hazard zones, but overall it was estimated that this effect should be less than the effect of increased vehicles waiting in the 3-lane shed option.

In addition to a reduction in the avalanche hazard, it was also estimated that these three snow sheds would result in greater than a 50% reduction in the average number of road closures and more than a 75% reduction in average closure hours, from 56 hours in 2018 to between 2 and 11 by 2050 in an average year, with snow sheds in place. More closure time could still be expected in extreme years.

Costs:

These proposed 3-lane snow sheds have been estimated to have costs between US \$72 and \$86 million depending on the exact length, alignment and whether guiding berms are used (Utah Department of Transportation, 2019). This is based on a total length of snow shed ranging from 2465 feet (with berms) to 3194 feet (without berms and road re-alignment). This indicates an approximate cost of US \$27,000 to \$29,000 per linear foot of structure (US \$88,500 to \$95,000 per linear meter). This is mostly comprised of the construction costs, with a planning-level construction cost estimate for three-lane snow shed being around US \$23,000 to \$25,000 per linear foot of structure³⁴ (US \$75,500 to \$82,000 per linear meter), with professional services, geotechnical explorations, an allowance for environmental mitigation, and contractor insurance, at assumed percentages making up the difference. This demonstrates that, in addition to the construction cost, additional services need to be considered that are on the order of 15% of construction costs.

The unit cost for construction of the Little Cottonwood Canyon sheds is much higher (by about double) than those described for European sheds in **Section 4.3** which is approximately US \$37,000 to US \$54,000 per meter, or approximately US \$11,300 to \$16,400 per ft. The reasons for this large discrepancy between European and North American costs is likely due to a number of reasons which the authors do not speculate on. However, one of the primary reasons is likely the much larger number of sheds that have been constructed in Europe, which is essentially a market-driven scale issue.

³⁴ HDR, 2019. Preliminary Cost Estimate for Three-lane Snow Sheds. Memo from HDR to John Thomas, UDOT. November 20, 2019.

Alternatives:

As part of the ongoing (August 2020) EIS process, alternatives to snow sheds are being considered, and these include the construction of a mid-valley gondola system or increased public transport (in combination with the construction of snow sheds) to reduce the traffic volume .

Prior alternatives proposed by F&P (2006) and Dynamic (2018a) including a tunnel, re-routing of the road to the other side of the valley / stream, cog rail transit, and bridges to cross the avalanche paths, all of which are no longer being evaluated.

A more detailed description of these alternatives, and the EIS process can be accessed at:

<https://littlecottonwoodeis.udot.utah.gov/draft-alternatives/>

Summary:

The proposed snow sheds in Little Cottonwood Canyon, and consideration of alternative options provides a robust example of a proposed snow shed development and the issues that need to be considered. It also provides the most recent cost estimates for construction and detailed analysis on risk reduction for North American snow sheds.

9. Case study Two: Current snow shed, Single Bench snow shed, Glacier National Park, B.C., Canada

To better illustrate a number of the topics covered in **Sections 2** through to **Section 7**, we have prepared three case studies. The purpose of these case studies is to present examples and a synthesis for a range of scenarios. This second case study provides an example of an existing snow shed approaching the end of its typical design life.

Location:

Trans-Canada Highway (Highway 1), Rogers Pass, BC, Canada

Timeframe:

1957 to the present.

Purpose / Motivation:

Initial investigations into avalanche hazards affecting the new Trans-Canada Highway 1 through Rogers Pass began in 1956-1960, several years prior to construction in the early 1960's (Schaerer, 1966). The locations of the snow sheds were finalized in 1959 when the highway grade was already under construction, so the sheds were "simply placed onto the fixed highway alignment" – this resulted in some geometric issues (e.g. sub-optimal horizontal curves) that contributed to traffic accidents at the sheds and still remain issues to current times. The length of the snow sheds was determined to protect against a 10-year maximum avalanches (Schaerer, 1966) which at that time was considered an acceptable standard – typically a minimum 30-year return period is now considered acceptable for snow shed lengths in North America.

Single Bench is one of five snow sheds that protect the highway against avalanches on the east side of Rogers pass, with large avalanches that descend off either side of the valley from Mt. Tupper (to the north) and Mt. MacDonald (to the south) (**Figure 40**). This area originally included a single control bench (thus the shed name) and earthfill mounds, which were subsequently removed. The Single Bench shed was constructed in 1978 (16 years after the highway opened) and included a constructed channel with two earthfill avalanche guiding berms. It was the last major avalanche defense structure constructed in GNP prior to the recent projects during 2015-2020 (e.g. Cougar Corner snow retaining nets, Mounds stopping berm).

Parks Canada Avalanche Control Section (ACS) maintains a very active artillery control program that controls some of the paths affecting the snow sheds, partly due to the potential for shed overfills and back spills, and also because of powder avalanches which routinely overtop the portals. This differs from many snow sheds that are designed so that an active control program is no longer needed (e.g. the Great Bear snow shed on the Coquihalla Highway). All of these sheds are aging and towards the end of their design life, with the oldest shed (Pioneer) approaching 60 years, and the youngest (Single Bench) at 42 years. Due to their advanced age,

all of these sheds have had significant rehabilitation work completed between 2015 and 2020, including drainage improvements on top and upslope of the sheds, debris removal from the shed roofs, column repairs and complete lighting upgrades to LED systems. Additionally, COWI North America (COWI) has recently completed structural analyses of the existing snow sheds to determine their current structural state and upcoming upgrades and maintenance needs as they push further into their design life. Any major upgrades (e.g. replacement) would require an expansion of the highway footprint from 2-lanes to 4-lanes, which presents challenges for replacement, i.e. challenging design and construction in a narrow valley with multiple overlapping avalanche paths, and thus high costs.



Figure 40: Single Bench avalanche path above the Single Bench snow shed. Single Bench avalanche path is the main path in the center of the photo, directed over the shed and confined by lateral guiding berms. The Mounds avalanche path is immediately west (photo left) of the shed. The Crossover avalanche path affects the shed from the opposite (south) side of the valley, requiring protection of the downslope shed wall (Photo: Dynamic Avalanche Consulting)

In discussions with the structural review engineers at COWI (D. Gagnon, pers. comm.), the snow sheds evaluated, including Single Bench, have sufficient remaining design life in their current state (plus with recent upgrades), but modifications with additional loads (e.g. guiding berm extensions, wing walls) are usually not possible due to increased surcharge on the shed roofs. This limits any further modifications of the sheds, or increases the costs of such modifications.

This section reviews design aspects of the Single Bench snow shed which is approaching the end of its design life, but still fulfills a critical role in the avalanche safety program in Rogers Pass.

Location and design criteria:

The Single Bench snow shed is located below the south face of Mt. Tupper, immediately east of the Rogers Pass summit in the Columbia Mountains of British Columbia. The Single Bench shed is 215 m (705 ft) long, with 2 lanes and supporting median columns. It is affected by frequent avalanches from the south face of Mt. Tupper (2805 m / 9200 ft elevation) which reach the shed below 1370 m (4490 ft) elevation. The shed is also affected by large cross-valley avalanches from the Crossover avalanche path on Mt. MacDonald. The western shed portal is also affected by avalanches from the Mounds path, which produces annual glide avalanches in the spring (March-May) that can deposit large (Size D3-D4) avalanche deposits onto the shed, and block the west portal with snow. These avalanches are difficult to forecast and the debris requires many hours to remove before the highway can be re-opened. The confluence of three large avalanche paths from different directions makes for a complex terrain geometry and challenging avalanche forecasting and control program at this location.

Single Bench has a high frequency of avalanches reaching the highway, with an average of 2.6 avalanches per year from the Single Bench path, one every 3-4 years from Crossover, as well as less frequent (approximately 1 in 8 years) but large (Size 4 or larger) avalanches reaching the west portal from Mounds path (**Figure 41**).



Figure 41: Single Bench overflow at the west portal due to a glide slab avalanche from the adjacent Mounds avalanche path, April 10, 2012. (Photo: Parks Canada Agency)

The Single Bench snow shed is approximately 215 m (705 ft) long, with two 9.3 m (30 ft 6 in) wide lanes (including concrete curbs) and a 0.45 m (1 ft 6 in) wide median column separation

The internal clearance height is 4.9 m (16 ft) (**Figure 42**). The structure was constructed using a combination of cast-in-place concrete foundations and upslope wall, combined with pre-cast concrete downslope wall panels and roof panels and pre-cast concrete support columns. This shed differs significantly from the other sheds in Glacier National Park and the BC MoTI Sheds in that it is completely enclosed with downslope concrete wall panels which provides protection from dense flow and powder flow cross-valley avalanches from the Crossover path.

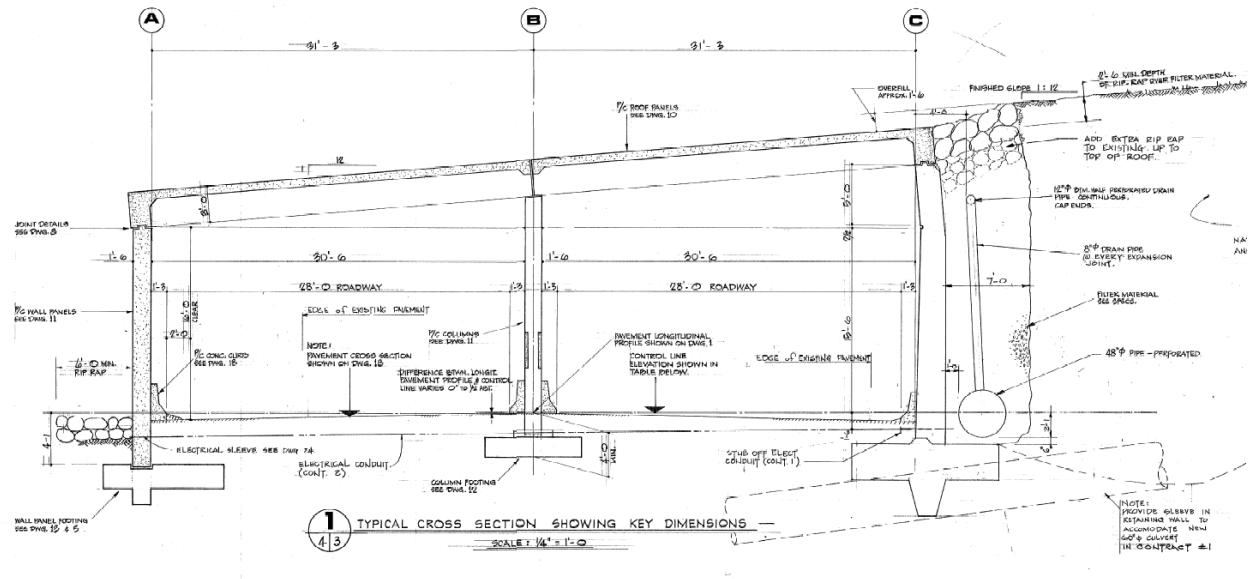

Figure 42: Single Bench snow shed typical cross section (Source: Parks Canada Agency)

The shed includes two large earthfill guiding berms, one located at each end of the shed which serve to confine avalanches from the Single Bench path directly on the shed and reduce the likelihood of portal spillovers. The berms vary in height between 15 m (50 ft) and 23 m (75 ft).

The potential for mitigating the hazard from Mounds using a snow shed extension was evaluated by Dynamic, during which it was determined that an 80 m (262 ft) snow shed extension to the west would be needed for a 30-year avalanche design event.

The original design drawings from 1977 included design snow avalanche loads on the Single Bench shed, as evaluated by Peter Schaerer and the structural engineers at that time. Load scenarios included: moving avalanche on bare roof, moving avalanche on previous deposit, maximum stationary snow deposit, and cross-valley load on the outside wall from Crossover. Dynamic completed a re-evaluation of loads on Single Bench in 2018, which estimated the Case 6 (downhill outside wall from Crossover) normal load in the range of 49-72 kPa, the upper limit of which agreed with the 1976 design construction plan value of 72 kPa (1500 psf). Case 3 was determined to provide the greatest normal (vertical) load, and acts in an opposite direction (i.e. from the Single Bench path) to the Case 6 results. Dynamic's Case 3 loads varied from a

maximum of 35 kPa (normal) and 3.5 (parallel) on the uphill side of the shed to 24 kPa (normal) and 2.8 kPa (parallel) on the downhill side of the shed. These estimated normal loads for this design scenario were lower than the 1976 loads on the construction plans, but higher than the loads provided in preliminary work completed by Schaerer (1962). The parallel loads are also lower than the 1976 loads on the construction plans. The difference in loads may have to do with additional factors applied to the 1976 construction plans.

The differences noted above highlight the importance of re-visiting the original design loadings for older sheds as they reach the latter stages of their design life, to ensure that the original assumptions are still applicable and that those loads are compatible with the current operational state of the shed. In some cases, the current shed may no longer provide the same strength characteristics as when it was originally designed (or there may be better avalanche occurrence and observational information available) that could be different than in the original design. This is relevant should there be a need to upgrade aspects of the shed, notably with extensions or additions of diversion berms or wing walls that could increase loading (total load or lateral distribution of load) on the shed roof.

Rehabilitation, Operations & Maintenance costs:

Recent upgrades to Single Bench shed include the addition of LED lighting and surface water drainage improvements on top of the shed. The lighting is a major improvement for this shed as it did not have natural lighting available due to the pre-cast concrete panel walls on the downslope side.

Table 7 presents several rehabilitation and annual operating costs associated with snow sheds in GNP, which was based on discussions and high-level costs estimates provided by Parks Canada. These costs are indicative of all five of the snow sheds in GNP, so the approximate individual cost for the Single Bench snow shed can be estimated by assuming it represents a fractional part of the total costs based on its 215 m (705 ft) length out of a total 1519 m (4984 ft) for the five snow sheds. Based on discussions with Parks Canada, recent lighting upgrades cost approximately CAD \$20 million, which included LED lighting for all five sheds, plus installation of a power transmission line to the sheds. That represents a unit cost of approximately CAD \$13,167 per lineal meter of shed which, for the Single Bench shed (215 m) is approximately CAD \$2.8 million (**Table 7**).

Annual maintenance of the lighting system (inspections, replacements, traffic control) is estimated to have an annual cost on the order of CAD \$250,000, or \$165 per lineal meter (a potential range is provided as well), plus CAD \$120,000 per year. These costs illustrate that, despite being energy efficient, modern lighting systems still represent a major capital investment and annual costs that should be considered for the life cycle of any snow shed.

The other recent major upgrades to the GNP snow sheds were extensive column repairs and improvement of the drainage system (vegetation and debris removal on the shed, drainage channels, etc.). Column repairs included chipping, forming, and finishing concrete work. These rehabilitation upgrades were estimated to cost CAD \$9.2 million, or \$6,100 per lineal meter of shed. For the 215 m Single Bench shed, that works out to approximately CAD \$1.3 million. Combined with the lighting upgrades (\$2.8 million) represents approximately CAD \$4.1 million in rehabilitation upgrades in the past five years (for a 42-year old snow shed) (**Table 7**).

Table 7: Estimated rehabilitation costs in CAD\$ for five snow sheds in Glacier National Park, 2015-2020 upgrades.

Shed	Length (m)	Length (ft)	Columns & Drainage	Lighting
Tupper Timber	258	846	\$1,562,607	\$3,396,972
Tupper #2	591	1939	\$3,579,460	\$ 7,781,435
Tupper #1	272	892	\$1,647,400	\$ 3,581,303
Lens	183	600	\$1,108,361	\$2,409,480
Single Bench	215	705	\$1,302,172	\$2,830,810
Total	1519	4984	\$ 9,200,000	\$20,000,000
Unit Cost (\$/m)			\$ 6,057	\$13,167

Table 8 highlights the approximate annual operations and maintenance costs that are associated with the GNP snow sheds. This list is likely not exhaustive as there will be many additional general maintenance costs associated with operation of the highway – these simply represent costs that would not be incurred if the sheds were not present. Costs include: annual shed washing (work crews, equipment and traffic control), lighting maintenance and replacement; power (hydro) for the lighting (monthly costs); general clean-up of drainage around the sheds (annual); cornice removal by crane truck (estimated 4 times per winter for all sheds, plus traffic control); widening of shed entries and removal of drifting/plowed snow (estimated 12 times per winter for all sheds, plus traffic control); in-shed icing removal (scraping with grader, salting, etc.). Many of these operational issues have been discussed in **Section 7**. From this table, very approximate (high-level) annual maintenance costs for the GNP sheds are estimated to be in the range of CAD\$ 400,000 to CAD\$ 600,000, or an average of CAD\$ 500,000. If this is simply averaged over five sheds, this represents an average annual maintenance cost of approximately \$100,000 per shed, or (preferably) a unit cost of CAD\$ 338 per lineal meter, per year (for 1519 m / 4984 ft length of snow sheds). For the 215 m (705 ft) long Single Bench shed, that represents approximately CAD\$ 72,500 per year in operation and maintenance costs (**Table 8**).

Table 8: Estimated annual operation and maintenance costs in CAD\$ for five snow sheds in Glacier National Park, plus a summary for the Single Bench snow shed.

Operations and Maintenance Cost	Range (min.)	Range (avg.)	Range (max.)	Unit Cost/m per year for 1519 m	Single Bench (215 m)
Shed washing: Traffic control	\$18,000	\$18,000	\$18,000	\$12	\$2,548
Shed washing: Crew and equipment	\$20,000	\$25,000	\$ 30,000	\$16	\$3,539
Lighting maintenance, replacements	\$150,000	\$250,000	\$330,000	\$165	\$35,385
Power (hydro) for lighting	\$120,000	\$120,000	\$120,000	\$79	\$16,985
Drainage clean-up/maintenance	\$15,000	\$15,000	\$15,000	\$10	\$2,123
Cornice removal by crane truck	\$ 20,000	\$22,000	\$24,000	\$14	\$3,114
Shed entry widening/snow removal	\$ 55,000	\$53,000	\$ 51,000	\$35	\$7,502
In-shed icing removal	\$ 10,000	\$10,000	\$10,000	\$ 7	\$1,415
Total Cost (\$)	\$408,000	\$513,000	\$598,000	\$ 338	\$72,610
				Single Bench (min.)	\$ 57,749
				Single Bench (avg.)	\$ 72,610
				Single Bench (max.)	\$ 84,641

Risk and residual risk:

The Single Bench snow shed is very effective in terms of reducing risk from the Single Bench avalanche path (Argue et al., 2018). This path has not affected the highway since the snow shed was constructed in 1978. However, there remains substantial hazard to the highway from the Mounds avalanche path, which affects the highway annually and requires an average of 11 artillery rounds per year to control. The glide slab releases from the track of the avalanche path each year and has a return period to the TCH of 8-years. The release is not predictable inside of a period of several days and it is usually not possible to release artificially. The glide slab has a typical release depth of 5-8 m (16 – 26 ft) and a size of D4 when it reaches the TCH, which is historically open at the time of release. The deposit requires many hours to remove before the highway can be reopened.

To address the glide slab avalanche hazard, an earthfill stopping berm is currently being constructed in the Mounds path which is designed to contain and stop a 30-year glide slab avalanche. This berm will vary in height up to 19.5 m (64 ft) and extend over a length of

approximately 200 m (650 ft) and is scheduled for completion in the fall of 2020. The approximate cost of this structure will be CAD\$ 3.6 million (US\$2.7 million), with an estimated annual maintenance cost of CAD\$ 60,000 (US\$ 45,000). The comparable snow shed extension to provide similar level of protection was estimated to cost CAD\$ 18 million (US\$ 13.5 million).

Dynamic completed an evaluation of AHI and Residual AHI reduction for this group of paths (Single Bench, Mounds and Crossover) (McElhanney, 2020). This evaluation resulted in the Mounds Stopping berm being the 5th highest ranked measure of the proposed options, and thus it was chosen for construction during 2019-2020. This structure will reduce AHI by -20 (with a starting value of 265, or about 8%) and increases the RAHI by 0.7 (starting value of 19, or about +3.7%). The increase in RAHI is solely due to the increasing traffic volumes projected during implementation, but the effect is essentially negligible. From this, it is apparent that there is a significant reduction in the AHI for this mitigation measure, but only limited change in the residual hazard (RAHI) for avalanches that reach the open highway. This relates to the relatively lower frequency of avalanches that reach the open highway (approximately one every 8 years from Mounds); but these events have very serious potential consequences and are highly disruptive (and costly) to the highway operations.

Operational issues and challenges

Section 7 has discussed a number of these issues, both design and operational, associated with the Single Bench snow shed. These challenges can be summarized with the following points:

- Single Bench snow shed is sufficiently long to mitigate hazard from the Single Bench path, but the adjacent Mounds path presents a hazard to the west shed portal – this could be mitigated by an 80 m (262 ft) long extension, but at a high cost of CAD\$ 18 million. The Mounds stopping berm provides a lower cost (CAD\$ 3.6 million) method to reduce the Mounds hazard for a 30-year design glide avalanche event – this mitigation measure was ultimately chosen for construction with planned completion in fall of 2020.
- Any future improvements of this shed will need to consider expansion from 2 lanes to 4 lanes, which will have very high costs and challenges given the narrow valley and adjacent Connaught creek. This challenge will apply to all of the snow sheds in the Trans-Canada Highway corridor (5 in Glacier National Park and 3 owned by BC MoTI), all of which have similarly challenging topographic, geometric and geotechnical constraints.
- The Single Bench snow shed is 42 years old as of 2020 and approaching the latter stages of its design life. Recent structural evaluation shows that the snow shed is sufficiently good shape to continue providing protection to the highway. Other snow sheds in this corridor are approaching 60 years in age, which is certainly closer to the end of their design life.

- The shed has recently been improved to include LED lighting, which will provide additional safety and potentially reduce accidents in the shed or at the portals.
- Rehabilitation upgrades to the snow sheds during 2015-2020 included removal of debris and vegetation accumulations from the sheds, as well as extensive column repairs. The Single Bench shed had limited vegetation and debris accumulations prior to this rehabilitation project, so the upgrades were focused on column repairs and LED lighting upgrades.
- Avalanches from the Crossover path on the other side of the valley were estimated by Schaerer (1962) to produce high pressures on the downhill side of the snow shed. The pressure was estimated between 500 lb/ft² (23.9 kPa) and 750 lb/ft² (35.9 kPa), and a sloping earth fill backfill on the downhill side was recommended. The constructed shed included pre-cast concrete panels that present a wall to avalanche flow from Crossover, and thus different loading patterns than in the original design. In re-evaluating snow sheds with old designs, it is important to consider how the loads were intended to be applied to the structure compared to the as-built structure. There may be differences that are significant, especially for older structures at the latter stage of their design life.

Summary:

The Single Bench snow shed in Rogers pass provides a robust example of an older snow shed which is approaching the end of its design life, but still fulfills a critical role in the avalanche safety program in Rogers Pass. The length of the shed is inadequate relative to typical modern acceptable standards in North America, and accordingly a high level of short-term control is used to address this deficiency. Improvements since construction also present examples of potential modifications.

10. Case study Three: Removed snow shed, Snoqualmie Pass, Washington, USA.

To better illustrate a number of the topics covered in **Section 2** through to **Section 7**, we have prepared three case studies. The purpose of these case studies is to present examples and a synthesis for a range of scenarios. This third case study provides an example of a snow shed that was removed, a new shed that was proposed to replace it, and an alternative bridge option that was ultimately constructed.

Location:

I-90, Snoqualmie Pass, Washington, USA.

Timeframe:

1950 to the present.

Purpose / motivation:

A two-lane wooden snow shed, East Shed, was constructed on I-90 on Snoqualmie Pass in the 1930's along Lake Keechelus. The East Shed was replaced with a concrete shed in 1950, at which time the highway was still two lanes wide. The shed was 500 ft (152 m) long and cost \$1.2 million in 1950 (equal to \$12.8 million in 2020 using a standard CPI inflation calculation). At the same time, the West Shed was built along an area known as Airplane Curve. Both sheds were built to cover both lanes of the two-lane highway at the time. The West shed remained in place until its removal in the early 1980's.

The highway was widened to four lanes in the late 1950's, but the shed remained unchanged. If an avalanche blocked the unprotected eastbound lanes, traffic was re-routed through the East Shed. However, before the implementation of an avalanche forecasting and control program, it was not uncommon for vehicles to be caught in avalanches prior to road closures. The West Shed was removed as part of a highway improvement project in the 1980's and was not replaced. However, the back concrete wall was left in place, and the fill behind it was removed, resulting in a small but effective catchment dam, which is still used today. In 1995, the Keechelus snow shed was placed on the National Register of Historic Places list. It represented the first time pre-cast construction was used for a highway structure in a mountainous area in the US. At the time it was the only interstate snow shed remaining (Derry, 2014) (**Figure 43**).

In the early 2000s a proposal was developed for the construction of a 335 m long, 6-lane snow shed to cover all three east bound and all three west bound lanes with a continuous roof span. Art Mears and Chris Wilbur contracted by URS designed the snow shed, and the project was put out for tender by Washington State DOT (URS, 2007; Wilbur and Stimberis, 2010). As part of this process Jacobs (the eventual designer) and Atkinson (the eventual builder) submitted a cost reduction incentive program (CRIP), in which a bidder to a tender can submit an alternate design that meets the project goals but can be constructed and/or maintained at a lower cost

to Washington State DOT. Cost savings are split 50/50 between the builder and the state if the design is accepted. The alternate design called for two 3-lane bridges to span the avalanche paths covered by the proposed snow shed, with avalanche debris going under the bridge, rather than over the snow shed roof. A key component to the success of this alternate design and the CRIP, was the reduced long-term maintenance and regulatory compliance costs associated with a 6-lane snow shed, which includes ventilation, lighting, fire suppression, and emergency response costs. This alternate bid was accepted, and following detailed analysis and review, in 2014 the East Shed was removed and replaced with the bridges which were completed in 2018 (Jones et al., 2014; Wilbur and Stimberis, 2010).



Figure 43: Aerial view of the East Shed in summer prior to its removal, showing the exposed east bound lanes, and covered west bound lanes. (Derrey, 2014)

Location and design criteria:

The Keechelus Snow shed or widely know as “the shed” was built in the spring, summer, fall and winter of 1950 to protect drivers from avalanches. The 500 ft (152 m) snow shed was 34 feet wide and had a concrete roof supported by a 30-foot-tall, 15-inch-thick retaining wall that was anchored into the hillside. The roof span consisted of 200 pre-cast concrete T-beams and the sides were detailed with false portal fronts bearing art deco detailing (Derry, 2014). This snow shed was removed in 2014.

Five avalanche paths (East Sheds 2, 3, 4, 5 West and 5 East), with frequent avalanche activity to the road determined the location of the original snow shed, the proposed shed, and the subsequent bridges. The proposed replacement snow shed originally suggested either two shorter snow sheds, or one long snow shed. The final snow shed proposal suggested construction of a large structure with a maximum inside height of 7 m (23 ft), a 36.7 m (120 ft) width, and a length of 335 m (1100 ft) - designed to accommodate six traffic lanes without a center support, and to cover the majority of the controlled avalanche terrain (Wilbur and Stimberis, 2010). In addition, the design called for graduated lighting to transition from daylight, a ventilation system, and traffic monitoring and communication systems. Snow nets in the starting zones for adjacent avalanche paths (in the Slide Curve Avalanche Area to the east and path East Shed 0 immediately west of the bridges) were also proposed, and these were constructed.

Ultimately, two 3-lane bridges were designed and constructed instead of the 6-lane snow shed. According to Jones et al., (2014), the bridges were designed to meet the following criteria:

- 100-year dense flow avalanches must pass underneath the bridges without impacting the superstructure;
- The bridges must provide sufficient clearance to accommodate the 100-year combined heights of: snowfall accumulation, snow plowed from the bridge deck, prior avalanche deposits, 100-year dense flow and 30-year powder avalanche flow;
- The bridges must be sufficiently high so that vehicles are not impacted by powder avalanches more frequently than once in 30 years;
- The bridge piers must be designed to withstand 100-year dense flowing avalanche impact loads. Structural designers factored these loads by 1.5 for the bridge piers. The dense flow and powder flow impacts to bridge columns were combined with other AASHTO Load and Resistance Factor Design (LRFD) load cases.
- Bridge columns were also designed for static loads due to accumulations of snow from snowfall, sluffing, plowed snow and avalanches. The Load Factor for static snow loads was 1.5. This load was added to the dynamic snow forces on the bridge.

The bridge design was constrained by many other highway engineering factors, including soil and rock stability, rockfall, foundation conditions, horizontal and vertical highway curves, seismic loading, environmental and aesthetic considerations, as well as cost.

An earlier proposal for longer bridges (further out into the lake) as part of the initial EIS was rejected³⁵, but the CRIP process proposed a design that avoided construction in the lake using

³⁵ Washington State Department of Transportation, Final Environmental Impact Statement Documents: Chapter 2
<https://www.wsdot.wa.gov/sites/default/files/2019/03/06/chapter-2-eis-i-90-project.pdf>

extensive rock cuts that allowed the bridges to be constructed closer to the slope. The bridge piers were placed strategically between the lateral boundaries of the respective avalanche paths and enhanced flow channels were constructed that would divert avalanche flow around the bridge piers rather than into them (**Figure 44**).



Figure 44: East Shed project area overview showing location of current highway, Keechelus Lake, seven East Shed avalanche paths, and proposed locations of bridges (green lines) and piers (pink dots) (from Jones et al., 2014)

As per the design criteria, powder avalanches are still permissible to reach vehicles on the bridge deck (less than once every 30 years), and while powder avalanches remain possible in this snow climate, and would result in reduced visibility and have the potential to push vehicles, they occur less frequently than in intermountain and continental snow climates and this residual risk was considered to be an acceptable level of risk.

Costs:

Construction of the 6-lane snow shed and two 3-lane bridges were provided comparable estimates of \$71 million prior to construction, which formed part of a larger \$177 million (in

2018) project that included the widening of I-90 from east of the Snoqualmie Pass summit through to Cascade Mountain Range. Atkins Construction (2020) estimated that their alternative solution (the bridges):

“...eliminated \$37 million in long-term snow shed operations and maintenance costs, minimizes construction impacts to the public, and increases the likelihood of achieving the project schedule. The twin 1,200-foot-long bridges rise over the avalanche chutes and can accommodate 100-year avalanche events to virtually eliminate road closures due to avalanche and snow removal.”

Ongoing maintenance costs:

Ongoing operational and maintenance costs for the old 500 ft snow shed were minimal (Stimberis, *pers comm.*, 2020), with no specific inspection schedule and only as-needed maintenance required. This included when, for example, the shed was hit by a vehicle or oversize load. In addition to these as-needed inspections, there was also occasional snow removal required when debris stacked up in a way that might cause it to fall on the eastbound traffic (a problem specific to a shed that only covered half the highway), and sometimes cornices would form on the portal parapets. These cornices generally required about 1 employee day every 3-4 years (Stimberis, *pers comm.*, 2020). Observations of the snow shed roof by Dynamic Avalanche Consulting prior to shed demolition showed extensive vegetation on and immediately above the shed roof, so it can be inferred that limited (if any) roof and drainage maintenance were completed during the life of the East Shed.

In contrast, the estimated ongoing operational and maintenance costs for the new proposed 335 m (1100 ft) snow shed were significant, with estimated one-time set up costs exceeding \$1 million (including the purchase of vehicles, traffic control truck, tools and equipment, office and bunkhouse etc.), and estimated annual operating costs of almost US \$800,000 (**Table 9**). During a 75-year (for example) design life, these costs could be expected to exceed US \$60 million, not including any needed rehabilitation costs.

Risk and residual risk

The residual risk to the traffic with the newly constructed side-by-side bridges is clearly much lower than the risk that was present with only the west bound lanes protected. Furthermore, with the planned widening of the highway, retaining this two-lane structure was no longer a viable solution. However, as per the design criteria, there does remain some residual risk to vehicles on the bridge (estimated at less than 1 in 30 years) from powder avalanches. Jones et al., (2014) estimated that due to the very low pressure powder avalanches (i.e. < 1.4 kPa) that only reduced visibility and not destabilization of a vehicle were likely, and accordingly vulnerability was reduced from 0.05 to 0.02 deaths per vehicle impacts, to account for visibility effects only.

The proposed 6-lane snow shed would have eliminated these avalanche risks completely (excluding the potential for shed overfills and backfills), but at a greater construction and ongoing operational cost. Furthermore, snow sheds also present the increased potential for vehicular accidents, which may yield an overall lower net beneficial outcome than when just the avalanche risk is considered solely.

Table 9: Estimated I-90 6-lane snow shed operational and maintenance costs.

One time / Set up Expenses = Purchases	Cost
4x4 pickup	\$ 25,000
Service truck	\$ 45,000
Manlift	\$ 160,000
Traffic Control Truck	\$ 90,000
Truck with TMA	\$ 90,000
Portable Communication equip	\$ 6,000
Test equipment & tools	\$ 50,000
Inventory & stock	\$ 50,000
Computer equipment	\$ 10,000
Maintenance management system	\$ 50,000
Office & vehicle storage / bunkhouse	\$ 500,000
Total one-time Setup / Expenses	\$ 1,076,000
Yearly Operating Expenses	
	Cost
Labor = 4 person crew	\$ 354,000
Materials = Lighting, ITS, fuel, etc	\$ 100,000
Electricity = Power usage expenses	\$ 250,000
Equipment Rental = TEF rental for purchased equipment	\$ 70,000
Total Yearly Operating Expenses	\$ 774,000

*From Jim Henderson Sept. 22nd, 2011 email to J. Stumberis.

Summary:

The removal, proposal and ultimately alternative to snow sheds on I-90 at Snoqualmie Pass provides a robust example of changing needs, and the use of an alternative solution to achieve a similar risk reduction. While raised bridges provided the best optimization between residual risk and costs in this case, these structures may not always provide the best solution. Steep grades would likely prevent raised bridges, as would settings with larger, more powerful powder avalanches (e.g. Little Cottonwood Canyon, Utah). So while this case study is a great example of a viable alternative, it is clearly not appropriate for all settings, and in all locations.

11. Summary

This report has been prepared for the Transportation Avalanche Research Pooled fund (TARP) members, to provide a synthesis on the use and design of snow sheds to protect transportation corridors against avalanches.

As illustrated in this report, transportation corridors throughout the world employ a variety of snow shed designs to protect against snow avalanche hazards. The design, cost, and residual risk is a function of a number of factors, including the nature of the avalanches, the location of the road relative to the avalanche path, the frequency of avalanche debris on the road, the volume of traffic, and the engineering design and associated regulations determining the construction and operations of these structures. Clearly, one type of snow shed does not meet all use-cases and in some cases may not be the optimal solution.

This report has documented which designs are currently in use, have been proposed, and/or are being designed in North America. We have documented differences in construction approaches, additional mitigation considerations (e.g. guiding berms, wing walls), and the resulting residual risk. We have also shown examples from international jurisdictions for consideration for potential future snow shed designs in North America. We have also documented historical and present day construction costs as a function of the design and actual and estimated operational and maintenance costs.

In conclusion, as noted by Schaerer (1967), the importance of adequate preliminary observation cannot be overemphasized at sites where avalanche defense works are required. The information obtained from these avalanche observations are necessary for design purposes and will provide savings that will more than compensate for the investment of money and time required to conduct them. History has shown that inadequately sized structures will be over topped (sometimes frequently), and will be unsuccessful at mitigating the intended hazard to the intended design level. Those responsible for the design of avalanche defense works should always bear in mind that avalanches are often erratic, surprising in their size, forms and unexpected courses. The planning and design of avalanche defenses should, therefore make allowances for the unknown Schaerer (1967).

To provide a digestible summary and synthesis of the information presented in this report, we present a table (**Table 10**) that presents important considerations and factors that need to be accounted for when considering a snow shed as an option for long-term avalanche mitigation.

Table 10: Important considerations for long-term avalanche mitigation using snow sheds

Avalanche Path	<ul style="list-style-type: none"> • Avalanche size (i.e. D1-D5) • Avalanche character (e.g. dry, wet, powder, plunging) • Avalanche path width and confinement • Frequency of avalanche debris to corridor • Nature of the avalanche debris (depth, length, potentially entrained material such as rocks and trees) • Path characteristics (e.g. confinement, cross and down slope shape, incline) • Location of deviation point
Alternative Mitigation Approaches	<ul style="list-style-type: none"> • Short-term (active) (e.g. RACS, hand charges, helicopter, preventative closures) • Long-term (passive) (e.g. realignment, bridges, berms, retaining structures) • Combination of both short-term and long-term
Potential alternatives to snow sheds (if using long-term)	<ul style="list-style-type: none"> • Realignment • Avoidance • Deflection / diversion structures • Catchment / stopping structures • Bridges • Tunnels • Supporting structures in start zone • Re-vegetation in start zone • Acceptance of risk
Design considerations (if snow sheds are selected)	<ul style="list-style-type: none"> • Corridor alignment relative to path (horizontal and vertical curves, super-elevation, steep grades) • Distance to deviation point • Consider terrain modifications / backfill • Define loading cases • Calculate loads for loading cases • Length of snow shed relative to design return period (e.g. design for 30-year versus 100-year event), risk tolerance for occasional overflows • Estimate spread of avalanche and depth at edges for parapet walls and/or guiding berms • Consider back-spill issues, and install protection (e.g. slats, mesh) if debris is unable to flow away (roof extension can prevent this) • Consider passive snow load on side on downhill side of snow shed • Consider potential for erratic avalanche flows in design (uncertainty) • If sheds are separated by short distance consider joining them • Design factor of safety or load factor (typically 1.1 to 1.5)
Cost considerations (if snow sheds are selected)	<ul style="list-style-type: none"> • Load and engineering considerations • Overall design, e.g. Reinforced Concrete / CMP / Arch • Open sided or enclosed (influences operational costs) • Overall length • FHWA regulations and compliance costs (e.g. lighting, ventilation, egress, emergency response) • Ongoing operational and maintenance costs, rehabilitation costs

Potential traditional snow shed design case	<ul style="list-style-type: none"> • Higher in avalanche path (e.g. upper runout zone or track) • Closer to deviation point (ideally more than 6x flow depth away) • Higher snow and avalanche loads • Consider berms to reduce overall length (and thereby cost) • If greater than 800 ft (244 m) in length, then three sided (open downslope face) to reduce likelihood to need all NFPA provisions in USA
Potential CMP or concrete arch shed design case	<ul style="list-style-type: none"> • Low in avalanche path • Far away from deviation point (>> 6x flow depth) • Appropriate back fill for structure, material source (borrow pit) • Extend portals (> 5-10 m) further than for traditional snow sheds • Consider berms to prevent portal overspill and CMP failure • Less than 800 ft (244 m) in length (not all provisions from NFPA apply in USA) • If longer than 800 ft (244 m), factor in ongoing operational costs for NFPA compliance in USA relative to reduced construction costs.

Thank you for the opportunity to complete this work on behalf of the TARP group. We hope that this report will provide a robust synthesis and help inform future planning in regards to the construction of snow sheds in North America.

Should you have any questions or require clarification on this report, please contact the undersigned.



Report prepared by:



Jordy Hendrikx,
PhD

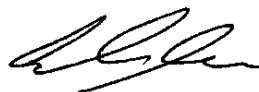

Andrew Schauer,
MSc.

Alan Jones,
MSc., P.Eng

Ryan Buhler,
MSc., EIT

Snow and Avalanche Lab
Department of Earth Sciences
Montana State University
Bozeman, Montana, USA

Dynamic Avalanche Consulting
Revelstoke,
British Columbia, Canada

E: Jordy.hendrikx@montana.edu

E: alan.jones@dynamicavalanche.com

12. References

- AES, Mears, A.I., 2004. Juneau Access Improvements Supplemental Draft Environmental Impact Statement (Appendix J: Snow Avalanche Report). Alaska Department of Transportation and Public Facilities.
- Argue, C. Buhler, R., Goodrich, J., Jamieson, B., Jones, A., Sanderson, J. 2018. Prioritizing avalanche mitigation measures for the Trans-Canada Highway through Glacier National Park. In: Proceedings of the 2018 International Snow Science Workshop, Innsbruck, Austria.
- Atkins Construction, 2020. I-90 Snoqualmie Pass East. <https://www.atkn.com/our-work/i-90-snoqualmie-pass-east>
- Alioth Finance, 2020. CPI Inflation Calculator [WWW Document]. URL <https://officialdata.org/us/inflation> (accessed 5.16.20)
- ASTRA/SBB. 2007. Richtlinie Einwirkungen infolge Lawinen auf Schutzgalerien. Bundesamt für Strassen, Bern, Bericht ASTRA Nr. 12 007. (revised edition; PDF available at <http://www.astra.admin.ch/dienstleistungen/>).
- BCBC, 2018. BC Building Code (BCBC). <https://www.bcpublications.ca/BCPublications/>
- BC MoTI, 2019a. Highway 1 snow sheds receive new sensed lighting (<https://news.gov.bc.ca/releases/2019TRAN0180-001979>)
- BC MoTI. 2019b. BC Supplement to TAC Geometric Design Guide, 2019 3rd Edition.
- Brox, D., Procter, P., Stethem, C. and Jones, A. 2007. Large avalanche protection canopies for mine access tunnel, Galore Creek Mine Project, BC, Canada. In: Proceedings of Snow Engineering VI, 2008.
- Buck, G., Hungr, O., and Schaerer, P., 2006. Mount Stephen avalanche and debris flows defence works investigation, design, construction and performance. In Sea to Sky Geotechnique 2006. 59th Canadian Geotechnical Conference and 7th Joint CGS/IAH-CNC Groundwater Specialty Conference. Vol. 2. pp. 1005-1012.
- Chris Stethem & Associates Ltd. 1991. Project No. 17-6-166: Mile 92.2, Mountain Subdivision, CP Rail. Report Revised 8 July 1991, prepared for Thurber Engineering.
- Conway, H., Carran, W., Carran, A., 2000. The Timing, Size, and Impact of Avalanches on the Milford Highway, New Zealand. Proceedings of the 2000 International Snow Science Workshop, October 1-6, Big Sky, Montana.
- CSA, 2019. *Canadian Highway Bridge Design Code*. CSA-S6:19. Canadian Standards Association.

- Derrey, S., 2014. The I-90 snow shed retires after 64 years! Traffic Payout Blog. <http://traffic-payout.blogspot.com/2014/03/the-i-90-snowshed-retires-after-64-years.html>
- Donner Summit Historical Society, 2016. Snowsheds of Donner Summit [WWW Document]. URL <http://www.donnersummithistoricalsociety.org/pages/exhibits/snowsheds.html> (accessed 5.23.20).
- Dynamic Avalanche Consulting Ltd., 2018a. Little Cottonwood Canyon Environmental Impact Statement: Snow Avalanche Hazard Baseline Conditions Report. Phase 1 report. Client report for HDR Engineering, July 3, 2018.
- Dynamic Avalanche Consulting Ltd., 2018b. Little Cottonwood Canyon Environmental Impact Statement: Snow Avalanche Hazard Improvement Options Report. Phase 2 report. Client report for HDR Engineering, October 4, 2018.
- Dynamic Avalanche Consulting Ltd., 2018c. Glacier National Park Snow Shed Design Analysis. Assessment of snow avalanche loading on Tupper 1 and Single Bench. Client report for COWI North America Ltd., January 10, 2018.
- Dynamic Avalanche Consulting Ltd., 2019. Little Cottonwood Canyon (SR-210) EIS – Snow shed lengths and mitigation. Memorandum to HDR Engineering, April 18, 2019.
- Fehr & Peers Associates (F&P), 2006. Little Cottonwood Canyon SR210 Transportation Study. Final Report. August 2006. Report prepared for UDOT.
- Föhn, P.M.B., Ammann, W.J., 1999. Snow avalanches, in: The WMO/UNESCO Sub-Forum on Science and Technology in Support of Natural Disaster Reduction. World Meteorological Organization, Geneva.
- Gerber, W. 2006. Guideline for the approval of rockfall protection kits. Environment in practice. Swiss Agency for the Environment, Forests and Landscape (SAEFL), Swiss Federal Research Institute WSL. Bern
- Hamre, D., and Steiner, R.W., 2006. Environmental implications for explosives base risk mitigation: A case study from the BNSF railway avalanche safety program, Essex, Montana, USA. In: Proceedings of the 2006 International Snow Science Workshop, Telluride, Colorado, USA.
- Hamre, D., 2009. Evolution of Avalanche Risk Reduction on the Alaska Railroad, in: Proceedings of the 2009 International Snow Science Workshop, Davos, Switzerland.
- Harrap, L., 2020. Semi truck collides with snowshed near Revelstoke in fatal crash. Revelstoke Review. <https://www.revelstokereview.com/news/semi-truck-collides-with-snowshed-near-revelstoke-in-fatal-crash/>

- Hungr., O., 1986. Mt. Stephen Snow Avalanche Dynamics Design Criteria. Original Memo June 5, 1986. Revised to June 23, 1986. Memorandum to G.F. Buck/Pile, P.A. Schaerer, NRC. File: 17-6-121.
- International Code Council, 2018. International Building Code. <https://www.iccsafe.org/>
- Jones, A., Johnson, G., Dusenberry, K., 2014. Quantitative Risk Assessment for the Snoqualmie Pass Avalanche Bridges, in: Proceedings of the 2014 International Snow Science Workshop. Banff, CAN, pp. 234–241.
- Kjøniksen, E., Kjønnås, P.B., Magnussen, S.B., Wiig, L.H., 2018. Fleksible kulverter i jord som alternativ til stive konstruksjoner. Bachelorstudium i ingeniørfag - Bygg Avdeling for ingeniørfag.
- Margreth, S., 2016. Falling snow and ice from buildings and structures: risk assessment and mitigation – two case studies (pp. 222-227). Presented at the 8th international conference on snow engineering 2016.
- Margreth, S., & Platzer, K., 2008. New findings on the design of snow sheds. In T. Johannesson, H. Eiriksson G., G. E., & J. (Eds.), International Symposium on Mitigative measures against Snow Avalanches (pp. 32-37). Egilsstadir.
- McClung, D., and Conger, S., 2001. Analysis of Power Plant and Dam Chutes, Provo Canyon, Utah. Report prepared for UDOT. 9 pages.
- McElhanney Ltd., 2020. Glacier National Park – Trans-Canada Highway Avalanche Mitigation Options Study: February 2020 Update.
- Mears, A.I., 2013. Avalanche Hazard Index Review, Snow Shed Cost Information, and Katzeihin Ferry Avalanche Mitigation, Juneau Access Improvements, Alaska State Project Number 71100, Federal Project Number: STP-000S (131).
- Mears, A.I., 2012. Structural Avalanche Defenses [WWW Document]. URL <https://mearsandwilbur.com/ASCE%202012%20Wilbur%20avalanche%20defense%20short.pdf> (accessed 5.24.20).
- Mears, A.I., 1995a. Avalanche Hazard Index for Colorado Highways. Colorado Department of Transportation Report No. CDOT-DTD-R-95-17.
- Mears, A.I., 1995b. Avalanche shed design and loading criteria Dam Avalanche, US 189 Provo Canyon. Report prepared for UDOT. April, 1995.
- Mears, A.I., 1992a. The East Riverside Avalanche Accident of 1992: Engineering and Snow-Safety Considerations, in: Proceedings of the 1992 International Snow Science Workshop, Breckenridge, CO. pp. 246–257.

- Mears, A.I., 1992b. Avalanche Characteristics and Structure Response: East Riverside Avalanche Shed Highway 550, Ouray County, Colorado. Report No. CDOT-DTD-R-92-4. U.S. Department of Transportation Federal Highway Administration.
- Mears, A.I., Newcomb, R.A., 1989. Teton Pass and Glory Bowl avalanche hazard and control analysis. Wyoming Highway Department.
- National Parks Service, 2008. Avalanche Hazard Reduction, By Burlington Northern Santa Fe Railway In Glacier National Park and Flathead National Forest, Montana. Final Environmental Impact Statement.
<https://parkplanning.nps.gov/document.cfm?parkID=61&projectID=12355&documentID=24072>
- NBCC, 2015. 2015 National Building Code of Canada. Canadian Commission on Building and Fire Codes, National Research Council of Canada, Ottawa, Ontario.
- NFPA, 2017. NFPA 502. Standard for Road Tunnels, Bridges and Other Limited Access Highways. National Fire Protection Association (NFPA). 2017 Edition.
- Parsons Brinkerhoff, 2003. Dam Chute Avalanche Mitigation US 189 Wildwood to Deer Creek State Park Provo Canyon. Project NH-0189-(12)14. April 9-10, 2003. Utah Department of Transportation.
- Platzer, K., 2008. Can the demands of actions of a rockfall shed and of a snow shed be fulfilled within one shed? Interdisciplinary Workshop on Rockfall Protection, Morschach, June 23-25, 2008, 87-89.
- Platzer, K., and S. Margreth. 2007. Experimental investigation of avalanche forces acting on snow sheds. Bundesamt für Strassen, Bern, Bericht VSS Nr. 613. (in German)
- Rudolf-Miklau, F., Schilcher, W., Kessler, K. and Suda, J., 2008. Life cycle management for technical avalanche protection systems. International Symposium on Mitigative Measures against Snow Avalanches Egilstadir, Iceland.
- Rudolf-Miklau, F., Sauermoser, S., Mears, A.I. 2015. The Technical Avalanche Protection Handbook. DE: Ernst & Sohn.
- Salek, M.E., 2013. Colorado Highways: Highway-Related Items [WWW Document]. URL <http://www.mesalek.com/colo/trivia/hwy.html> (accessed 5.22.20).
- Schaerer, P.A., 1966. Snow shed location and design. Journal of the Highway Division, ASCE, 92, No. HW2, pp. 21-33, 1967.
- Schaerer, P.A., 1962. Planning Avalanche Defense for the Trans-Canada Highway at Rogers Pass, B.C., The Engineering Journal. Vol 45, No. 3, pp31-38.
- Schaerer, P., 1989. The Avalanche Hazard Index. Annals of Glaciology, 13, 241-247.

- Schaerer, P., 1999. Recommendations for design of a snow shed: White Pine avalanche chutes, Little Cottonwood Canyon, Utah. 3 August, 1999
- Schellenberg, K., 2009. On The Design of Rockfall Protection Galleries. Hochschulverlag an der ETH Zürich, Zürich. [http://refhub.elsevier.com/S0165-232X\(16\)00020-3/rf0125](http://refhub.elsevier.com/S0165-232X(16)00020-3/rf0125)
- Schweizer, J., Mitterer, C., Stoffell, L., 2008. Determining the Critical New Snow Depth for a Destructive Avalanche by Considering the Return Period. Proceedings of the International Snow Science Workshop, Whistler, B.C., Canada.
- State of Alaska Department of Transportation and Public Facilities, 2018. FHWA Issues Record of Decision on Juneau Access [Press Release]. URL http://dot.alaska.gov/comm/pressbox/arch_2018/PR18-1032.shtml
- Statens vegvesen (Norwegian Public Roads Administration), 2014. Håndbok V138 - Veger og snøskred. In Norwegian. https://www.vegvesen.no/attachment/740624/binary/1003961?fast_title=H%C3%A5ndbok+V138+Veger+og+sn%C3%B8skred.pdf
- Statens vegvesen (Norwegian Road Administration), 2015. The National Road Data Base, NVDB Datakatalog. <http://labs.vegdata.no/nvdb-datakatalog/66-Skredoverbygg>.
- Stimberis, J., 2020. WSDOT Avalanche Forecast Supervisor. Personal communications regarding Washington Department of Transportation snow sheds.
- SLF, 2000. Der Lawinenwinter 1999 – Ereignisanalyse, (Ammann, E.j>, Ed.) Eidg. Institut für Schnee- und Lawinenforschung SLF, Davos, Switzerland, 588pp. (with English summary).
- TAC, 2017. Geometric Design Guide for Canadian Roads. Transportation Association of Canada (TAC).
- Utah Department of Transportation (UDOT), 2020. Little Cottonwood Canyon, Environmental Impact Statement. Avalanche Mitigation Alternatives. https://littlecottonwoodeis.udot.utah.gov/https://littlecottonwoodeis.udot.utah.gov/wp-content/uploads/2020/05/10265_3_LCC_Public_Factsheets_Avalanche_Mitigation_FIN_WEB.pdf
- Utah Department of Transportation (UDOT), 2020. Draft Snow Shed Concepts. Little Cottonwood Canyon Environmental Impact Statement S.R. 210 - Wasatch Boulevard to Alta. Utah Department of Transportation. May 11, 2020. https://littlecottonwoodeis.udot.utah.gov/wp-content/uploads/2020/06/LCC-EIS-Alternative-Screening-Report-2020-05-21_AppendixJ.pdf
- URS, Mears, A.I., 2007. I-90 Snoqualmie Pass East Project Avalanche Mitigation Report Avalanche Analyses. Washington State Department of Transportation.

- Vaslestad, J., 1990. Soil structure interaction of buried culverts. Trondheim: Institutt for geoteknikk, Norges tekniske høgskole. PhD thesis.
- Vaslestad, J., Østlid, H., Johansen, T.H., Holm, W., 1997. Flexible Steel Pipes Avalanche Canopies and Tunnels, 14 Years Experience (Fleksible Stål Rør som Skredoverbygg og Vegtunneler, 14 Års Erfaring). Norway (in Norwegian).
- Wadi, A., Pettersson, L., Karoumi, R., 2016. Flexible culverts in sloping terrain: Numerical simulation of avalanche load effects. *Cold Regions Science and Technology*, 124, 95-109, <https://doi.org/10.1016/j.coldregions.2016.01.003>
- Washington State Department of Transportation. 2008. Architectural Design Guidelines I-90 Snoqualmie Pass East. February 8, 2008.
- Wilbur, C., Stimberis, J., 2010. I-90 Snoqualmie Pass: Evolution of an interstate highway avalanche program. In: *Proceedings of the 2010 International Snow Science Workshop*, Squaw Valley, CA.
- Winther, I., 2017. Solbjørnneset rassikring: Mild, myk og liken. *Architectnytt* (Norwegian Architectural Magazine) April 20, 2017. <https://www.arkitektnytt.no/nyheter/solbjornneset-rassikring-mild-myk-og-leken>
- Woods, J.G., 2014. From Sputnik to the Great Bear: Avalanche snowsheds on Canadian Highways. *The Avalanche Journal*, Vol 105, 34-35. Feb 16, 2014. https://issuu.com/theavalanchejournal/docs/caj_vol105rhino
- Wyoming Department of Transportation, 1992. Feasibility of snow sheds on Teton Pass.
- Yount, J.M., Gorsage, B.R., 2016. Evolution of an avalanche program: from artillery to infrastructure. In: *Proceedings of the 2016 International Snow Science Workshop*, Breckenridge, CO. pp. 442–449.

Appendix A: Summary table of snow sheds in North America

Organization & Contact	Status			Name(s) / Location	Details / Location	Time period	Construction methods	Length (ft / m)	Estimated design loads (psf / kPa)	Estimated risk reduction	Cost (date) / Cost (now)	2020 Est. Cost per ft and m	Comments	References
	Historical	Current	Proposed											
Colorado DOT Jamie Yount				Riverside shed (CO 550),	CO550 – East Riverside Path (Phase 1). Proposed phase 2 and 3 would also cover the West Riverside path.	Built in 1985.	Original design called for the shed roof to rest on a five-foot wide bench carved into the bedrock. However, the rock was found to be substantially altered during excavation and the back wall ended up being built with reinforced concrete.	Phase 1: 450 ft (137 m) <i>(Only 180 ft (55 m) was built).</i> Proposed Phase 2: 465 ft (142 m) Proposed Phase 3: 365 ft (111 m)	Static: 1800 psf/ 95.8 kPa Dynamic: 1000 psf/ 47.9 kPa	50%. The completed Phase 1 structure would reduce hazard by 80%.	\$2.5 million in 1984 \$6.1 million in 2020	\$33,900 per ft \$110,900 per m	Riverside shed was planned for longer length. Built too short. In 1992, a CDOT employee was killed in an avalanche while clearing debris from a previous smaller avalanche that left four motorists stranded in the snow shed.	Mears, 1990; Mears, 1992a Mears, 1992b
Colorado DOT Jamie Yount				Alberta shed (US 160)	US 160- Alberta shed located on Wolf Creek Pass below the Alberta path.	Alberta completed in 1965.	Alberta: Reinforced concrete	379 ft (115 m)	No design load information available	No risk information available	No cost information available	No cost information available	Very little information available for the Alberta shed on Wolf Creek Pass (US 160).	Salek, 2013. Wilbur pers comm., 2020
Utah DOT Chris Covington				Provo: Power Plant Chute Dam Chute	Proposed in Provo	Designed in 1995, Proposed in 2001, Value engineered in 2003	Power Plant Chute protected by building an elevated highway on top of a deflection berm. Runout height not high enough to reach the road. Snow shed recommended for Dam Chute. Concrete shed with earthen fill upslope of shed to reduce impact pressures. Excavated channel immediately upslope of the shed, along with 5m high walls on either end of the shed to direct avalanche over the shed and minimize likelihood of debris spilling over onto the road.	130 ft (40 m)	292 psf (14 kPa) if an area upslope of the roof is filled to reduce vertical loading. 5117 psf (245 kPa) if the slope is not filled upslope of the shed.	Parsons and Brinckerhoff (2003) did not quantify, but found the snow shed to have the greatest reduction in risk when compared with a forecasting/ mitigation plan and a catchment/ buffer wall.	\$1.8 million in 2003 \$2.5 million in 2020	\$19,230 per ft \$62,500 per m	In 1997 there were 10 avalanches, some artificially triggered and some natural, that reached the highway. In the last ten years there has not been much snow at this path's elevation.	Mears, 1995 McClung and Conger, 2001 Parsons Brinckerhoff, 2003

Organization & Contact	Status			Name(s) / Location	Details / Location	Time period	Construction methods	Length (ft / m)	Estimated design loads (psf / kPa)	Estimated risk reduction	Cost (date) / Cost (now)	2020 Est. Cost per ft and m	Comments	References
	Historical	Current	Proposed											
Utah DOT Damian Jackson				LCC: White Pine Chutes 1-4 White Pine	Proposed in LCC	Proposed in 1989, 2006, 2018.	Reinforced concrete, anchored to bedrock, and/or backfill, and where needed backfilled to the roof on the uphill side with compacted fill to reduce impact forces. 10ft parapet wall on western portal of White Pine Chutes 1-4 snow shed.	Schaerer, 1989 F&P, 2006 2485 ft / 757 m Dynamic, 2019 2465 – 3194 ft 751 – 974 m	Dynamic, 2019 normal loads were between 790 and 697 psf (37.7 - 33.4 kPa), and the resultant Parallel loads were between 116 to 105 psf (5.6 kPa – 5.0 kPa). Passive loads were 118 psf (5.6 kPa), and the dynamic load on the outside wall on Little Pine was 188 psf (9.0 kPa)	24% reduction in AHI and 34% reduction in residual AHI	\$72 to \$86 million (2020)	\$27,000 to \$29,000 per ft. \$88,500 to \$95,000 per m	Snow shed one of the options being considered as part of a wider EIS process.	Schaerer, 1989 F&P, 2006 Dynamic, 2018a; 2018b; 2019
Washington DOT John Stimberis				Airplane Curve and Keechelus Lake Snow Shed	All removed – west side shed and East Shed by Keechelus Lake on I-90	1931-2014	A concrete snow shed built in 1950.	Airplane Curve: 1300 ft (396 m) Keechelus Lake: 500 ft (152 m)	Unavailable for the historic sheds.	No risk information available	East Shed: \$1.2 million (1950)/ \$12.8 million (2020)	\$25,600 per ft. \$84,000 per m	Removed the West shed, and then the concrete East snow shed by the lake.	Mears and Wilbur and older plans etc.; URS Corp. and Mears, 2007; Wilbur and Stimberis, 2010;
Washington DOT John Stimberis				Keechelus Lake Snow Shed	Proposed	Proposed in early 2000s	A 6-lane snow concrete snow shed was proposed	1100 ft (335 m)	URS Corp. and Mears (2007) = Static normal loads between 1000 and 1450 psf (48.9 to 69.4 kPa) & impact loads at 300-1450 psf (14.36 - 69.4 kPa).		East Shed replacement (6 lanes): \$71 million (2014) \$78 million (2020)	\$70,900 per ft. \$232,500 per m	Mears and Wilbur planned 6-lane replacement. Ended up using a bridge instead.	Jones et al., 2014; URS Corp. and Mears, 2007; Wilbur and Stimberis, 2010;

Organization & Contact	Status			Name(s) / Location	Details / Location	Time period	Construction methods	Length (ft / m)	Estimated design loads (psf / kPa)	Estimated risk reduction	Cost (date) / Cost (now)	2020 Est. Cost per ft and m	Comments	References
	Historical	Current	Proposed											
Wyoming DOT John Fitzgerald				Glory Bowl, Lower Twin	Proposed Teton Pass	Proposed in 1989	Glory shed to be constructed with reinforced concrete, anchored to bedrock at either end, and backfilled to the roof on the uphill side with compacted fill to reduce impact forces.	Glory Bowl 280 – 450 ft (85-137 m); Lower Twin 250 ft (76 m) for	Dynamic: 1700 psf / 81.4 kPa Static: 1100 psf / 52.7 kPa	Avalanche sheds would virtually eliminate hazard for the two paths, which would account for a 49% reduction for all of Teton Pass.	\$17.4 million \$31.8 million	\$60,000 per ft \$198,000 per m	Construction plans were drawn in 1992, but the structures were never built. Cost-benefit analysis measuring expense and risk reduction favored investment in non-structural mitigation. WYDOT had attempted to build a suspension bridge spanning the Glory Bowl path in 1968, but the bridge was destroyed by a large avalanche just as it was about to be completed in January 1970.	Mears and Newcomb, 1989. Yount and Gorsage, 2016.
Alaska DOT				Juneau Access Improve.	Three snow sheds and one bridge proposed for paths near the East Lynn Canal	Originally proposed in 2004, updated in 2006 and 2013. The state canceled the entire project in 2018 due to budget issues.	Reinforced concrete or steel culverts.	1500 ft (457 m)	1250 – 1750 psf (60 – 84 kPa)	Three snow sheds would reduce AHI by 57% in the East Lynn Canal area.	\$20 - \$30 million in 2013 \$22-\$33 million in 2020).	\$15,000-\$22,000 per ft \$48,000-\$72,000 per m	Short records resulted in large uncertainties in return intervals and size of design avalanches.	Mears, 2013; AES and Mears, 2004
Alaska Railroad Matt McKee / Dave Hamre				Multiple wooden sheds designed and built between 1917 & 1943	Sheds built at Kern path, miles 43, 50. 76, as well as at least four additional sheds whose locations are unclear.	Historical sheds removed by 1965.	All historical sheds were wooden. Materials were not specified for Kern and Centerline paths.	Historic sheds 120 ft (37 m) to 1002 ft (304 m).	Not Specified.	Two sheds would account for an additional 39% reduction in risk after other measures	\$850k annually (2009) \$1.0 m annually (2020)	No breakdown on operational vs construction costs	Wooden snow sheds were used until their removal in 1965. 1981-1986: Designated 'slide zones' 1986-2000: Explosives mitigation introduced. 2000-2009: Improvements in explosives delivery, avalanche detection, forecasting, and weather stations.	Hamre, 2009;

Organization & Contact	Status			Name(s) / Location	Details / Location	Time period	Construction methods	Length (ft / m)	Estimated design loads (psf / kPa)	Estimated risk reduction	Cost (date) / Cost (now)	2020 Est. Cost per ft and m	Comments	References
	Historical	Current	Proposed											
BNSF Railway Adam Clark				Shed 4D Shed 5 Shed 6 Shed 7 Shed 8 Shed 9 Shed 10 Shed 10.7 Shed 11 Shed 12 Shed 4C		1930 – 1912 – 1912 – 1913 – 1912 – 1912 – 1913 – 1923 – 1913 – 1927 – 1930 - 78	Concrete retaining walls on the uphill side of the rail grade, with the structures framed using large wooden timbers over the two sets of railroad tracks	1100 ft 380 ft 820 ft 1000 ft 650 ft 400 ft 500 ft 670 ft 400 ft 1360 ft 0 (burned down)	Not specified	AHI is estimated at 110 as mitigated, but unmitigated AHI is unknown	Estimates between \$7,000 and \$20,000 per ft (\$23,000 to \$67,000 per m) in 2006	Estimates between \$9000 and \$26,000 per ft (\$29,000 to \$86,000 per m) in 2020	EIS process in 2006-2008 included a proposal for five new sheds (unnamed) and extensions to seven others.	National Parks Service, 2008
Glacier National Park, Canada Parks Canada				Tupper Timber	Rogers Pass East, Glacier National Park	1962 - Present	All concrete structure, with wood slats on the downslope wall. LED lighting installed in 2019.	258 m	Unknown	Unknown	CAD \$1.01 million (1963, combined with Lens Extension contract)	Estimate CAD \$101,250/m (\$30,860/ft)	4.4m vehicle clearance height, and approx. 6% grade	
Glacier National Park, Canada Parks Canada				Tupper #2	Rogers Pass East, Glacier National Park	1962 - Present	All concrete structure, with wood slats on the downslope wall. LED lighting installed in 2019.	591 m	Unknown	Unknown	CAD \$1.33 million (1962, combined with Tupper #1)	Estimate CAD \$102,600/m (\$31,272/ft)	4.4m vehicle clearance height, and approx. 6% grade	
Glacier National Park, Canada Parks Canada				Tupper #1	Rogers Pass East, Glacier National Park	1962 - Present	Tupper #1: cast-in-place steel-reinforced upslope gravity wall, pre-cast beams and columns, cast-in-place roof slab and pre-cast parapet walls Pioneer: Metal arch, concrete columns and roof Original two sheds had ~30 m gap which was joined in 1966. Wood slats on downslope wall. LED lighting installed in 2019.	272 m	Schaerer 1962 Tupper #1: Vertical moving load 23.9 kPa, Vertical deposit load 19.2-47.9 kPa. Pioneer: Vertical moving load 19.2 kPa, Vertical deposit load 14.4-33.5 kPa, Dynamic avalanche load 4.8-10.5 kPa	Unknown	CAD \$1.33 million (1962, combined with Tupper #1)	Estimate CAD \$102,600/m (\$31,272/ft)	4.4m vehicle clearance height, and approx. 3 to 6% grade	Schaerer 1962 Dynamic, 2018

Organization & Contact	Status			Name(s) / Location	Details / Location	Time period	Construction methods	Length (ft / m)	Estimated design loads (psf / kPa)	Estimated risk reduction	Cost (date) / Cost (now)	2020 Est. Cost per ft and m	Comments	References
	Historical	Current	Proposed											
Glacier National Park, Canada Parks Canada				Lens	Rogers Pass East, Glacier National Park	1962 - Present	All concrete structure, with wood slats on the downslope wall. LED lighting installed in 2019.	183 m	Unknown	Unknown	CAD \$805,882 (1962, combined with Tupper #3) Lens Extension (combined with Tupper Timber) CAD \$1.01 million (in 1963)	Estimate CAD \$102,600/m (\$31,272/ft)	4.4m vehicle clearance height, and approx. 6% grade	
Glacier National Park, Canada Parks Canada				Single Bench	Rogers Pass East, Glacier National Park	1978 - Present	Cast-in-place canopy, center columns and 2 walls between the center columns at each end. Wood slats on the downslope wall. LED lighting installed in 2019. Solid downslope wall	215 m	Schaerer 1962 Single Bench: Vertical moving load 14.4 kPa, Vertical deposit load 14.4-21.6 kPa Schaerer 1962 Crossover: Dynamic avalanche load 23.9-35.9 kPa DAC 2018: Maximum 100-year loads for the Single Bench snow shed are estimated to be: Case 6: 49-72 kPa, Case 3: 34.6 kPa (qn) and 3.5 kPa (qp)	Unknown	Unknown	Unknown	4.9m vehicle clearance height, and approx. 2% grade	Schaerer 1962

Organization & Contact	Status			Name(s) / Location	Details / Location	Time period	Construction methods	Length (ft / m)	Estimated design loads (psf / kPa)	Estimated risk reduction	Cost (date) / Cost (now)	2020 Est. Cost per ft and m	Comments	References
	Historical	Current	Proposed											
BCMOTI				Lanark	Revelstoke East, B.C., Canada	1962 - present	All concrete structure: concrete columns, pre-stressed concrete beams, cantilever retaining wall, cast in place concrete tie-back anchor. LED lighting added in 2019	316 m	Vert deposit load 800 psf (W) 400 psf (E) Vert avalanche load 600 psf (W)t 400 psf (E) Horizontal load 300 psf (W) 300 psf (E). Simultaneous loading Vert 1100 psf (W) 800 psf (E) Simultaneous loading Vert 300 psf (W) 200 psf	Unknown	Unknown	Unknown	Cantilevered wing wall above west and eastern portal; wire mesh on downslope side; earthfill guiding berms 4.4m vehicle clearance height eastbound, 5.2 m vehicle clearance height westbound.	
BCMOTI				Twin	Revelstoke East, B.C., Canada	1962 – Present	All concrete structure: concrete columns, pre-stressed concrete beams, cantilever retaining wall, cast in place concrete tie-back anchor. LED lighting added in 2019	188 m	Unknown	Unknown	Unknown	Unknown	Wire mesh on downslope side, two downslope concrete buttresses 4.4m vehicle clearance height eastbound, 5.2 m vehicle clearance height westbound.	
BCMOTI				Jack MacDonald	Revelstoke East, B.C., Canada	1962 - Present	All concrete structure: concrete columns, pre-stressed concrete beams, cantilever retaining wall, cast in place concrete tie-back anchor. LED lighting in 2019	141 m	Unknown	Unknown	Unknown	Unknown	Wire mesh on downslope side 4.4m vehicle clearance height eastbound, 5.2 m vehicle clearance height westbound.	
BCMOTI				Great Bear	Coquihalla, B.C., Canada	1986 - Present	Concrete columns, pre-stressed concrete beams, waterproof roof membrane, cantilever retaining wall, cast in place concrete tie-back anchors and beams, 8 cast in place shear walls; center concrete columns between EB/WB lanes.	285 m	35 kPa normal load	Unknown	Unknown	Unknown	Wing walls above both shed portals, wire mesh on downslope side, finished concrete surface treatment above portals (bears). 8% road grade, 4.88 m minimum vehicle clearance height eastbound, 4.98 m minimum vehicle clearance height westbound.	

Appendix B – Colorado DOT

This appendix contains the details on the East Riverside snow shed on CO 550.

B1. East Riverside Snow shed (As-Built)

3 pages with plan and cross sections diagrams for the Phase 1 structure.

Source: Stearns-Rogers/Colorado Division of Highways Plan and Profile of Proposed Federal Aid Project No. FC550-2(10).

AS CONSTRUCTED		
NO REVISIONS	REVISED 3-7-86	VOID

FED. ROAD REGION	DIVISION	PROJ. NO.	SHEET NO.	SHEET TOTALS
VIII	COLO.	FC550-2(10)	4A _x	

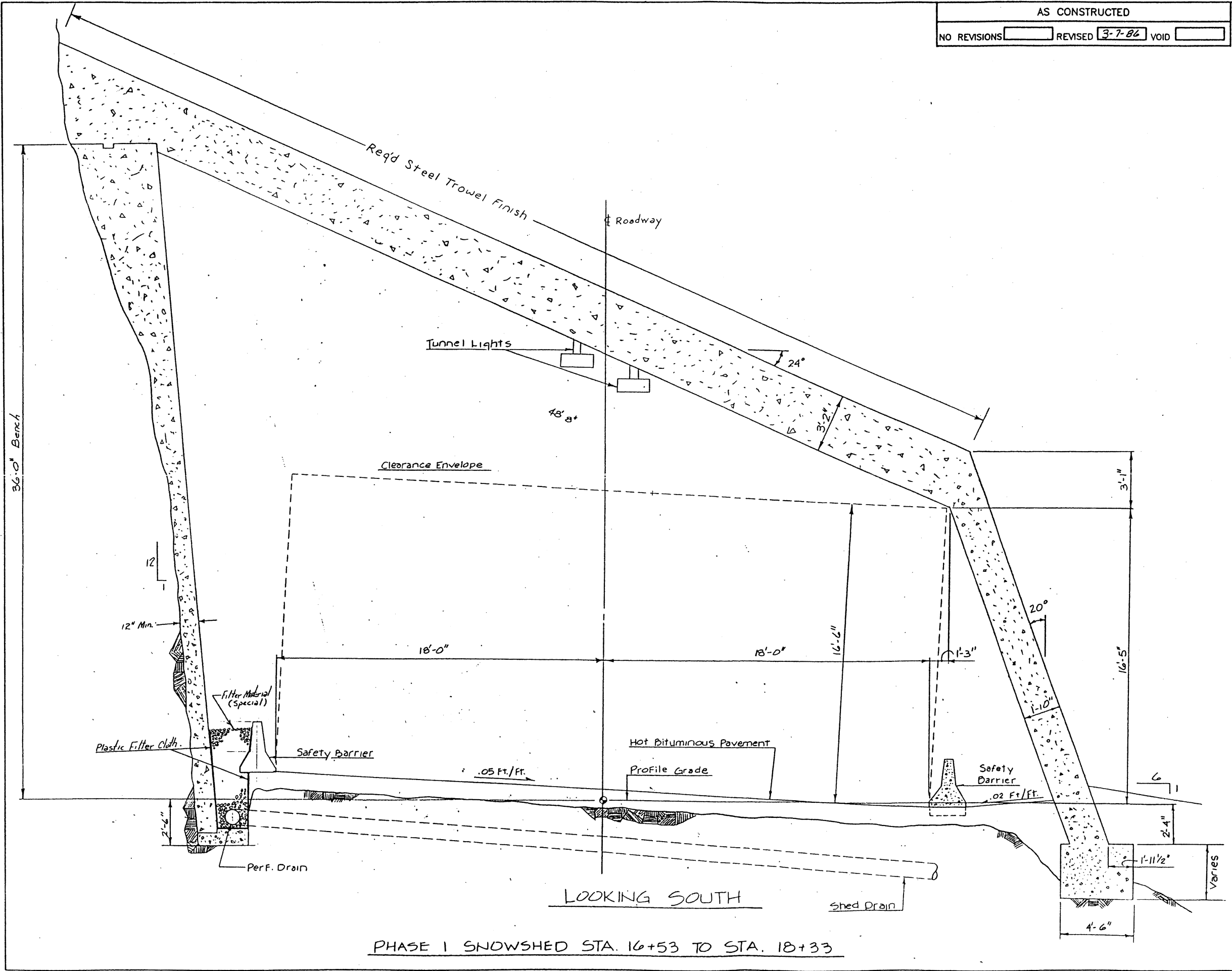

PHASE I SNOWSHED STA. 16+53 TO STA. 18+33

DIVISION OF HIGHWAYS	
PHASE I	
TYPICAL	
SNOWSHED DIMENSIONS	
Structure Number	M-06-AG

AS CONSTRUCTED		
NO REVISIONS	REVISED 3-7-86	VOID

FEDERAL ROAD REGION NO.	DIVISION	PROJ. NO.	SHEET NO.	TOTAL SHEETS
VIII	COLORADO	FC550-2(10)	16	

REVISIONS			

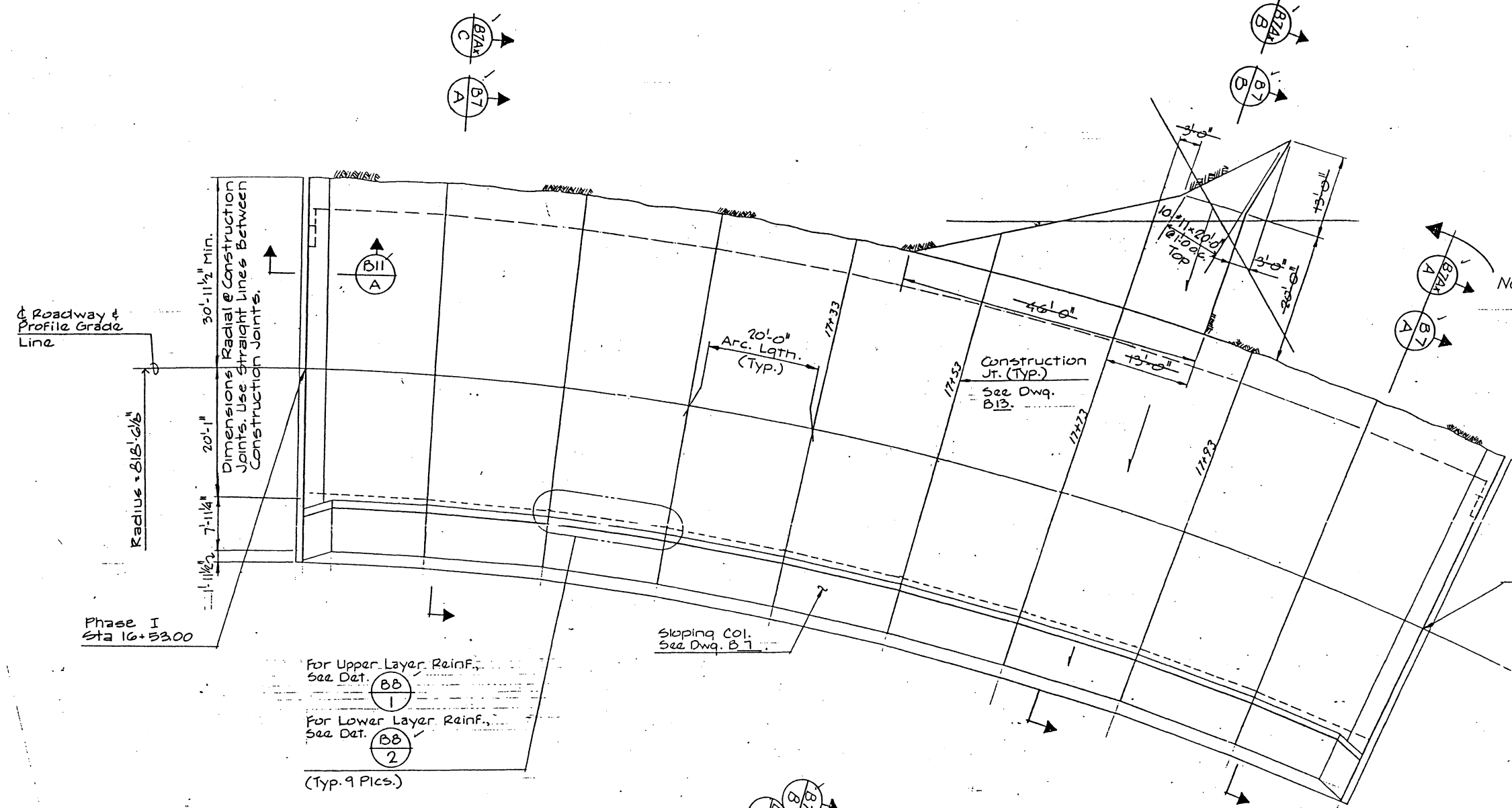
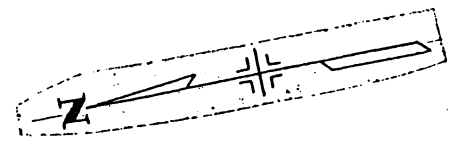

Phase I
Sta 16+53.00

Radius = 818'-0 1/2"

30'-1 1/2" Min.

20'-0"

7'-1 1/4"

Dimensions Radial @ Construction Joints. Use Straight Lines Between Construction Joints.

of Roadway & Profile Grade Line

For Upper Layer Reinf.,
See Det. BB
1

For Lower Layer Reinf.,
See Det. BB
2

(Typ. 9 Pics.)

Sloping Col.
See Dwg. B7

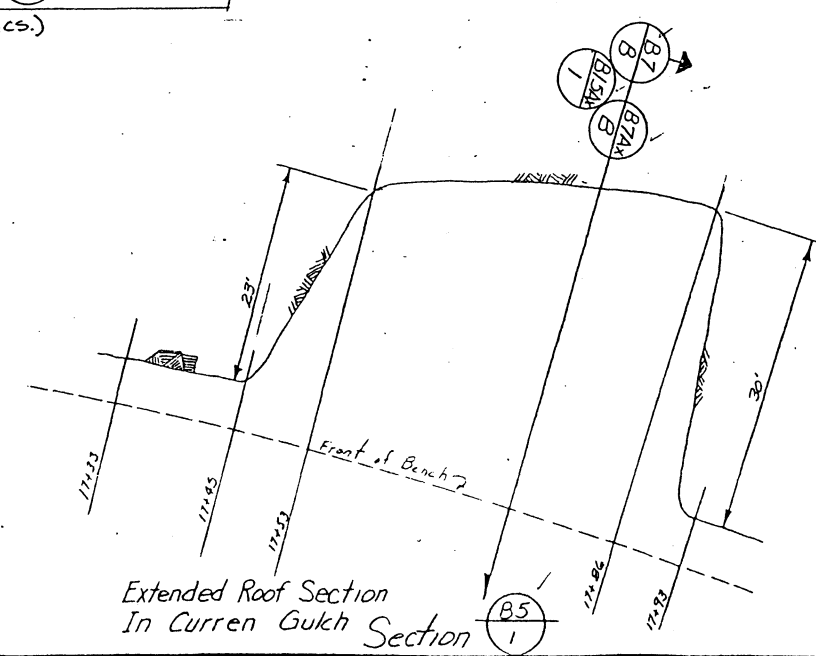

Extended Roof Section
In Curren Gulch Section

DIVISION OF HIGHWAYS			
PHASE I ROOF PLAN			
Designer	D. WEIR	Structure Numbers	M-06-AG
Detailer	B. KRZILEK	Drawing Number	B5
		of 18	Drawings

Stearns-Roger
INCORPORATED
4500 CHERRY CREEK DRIVE
BOX 5888 DENVER, COLORADO 80217
(303) 758-1122

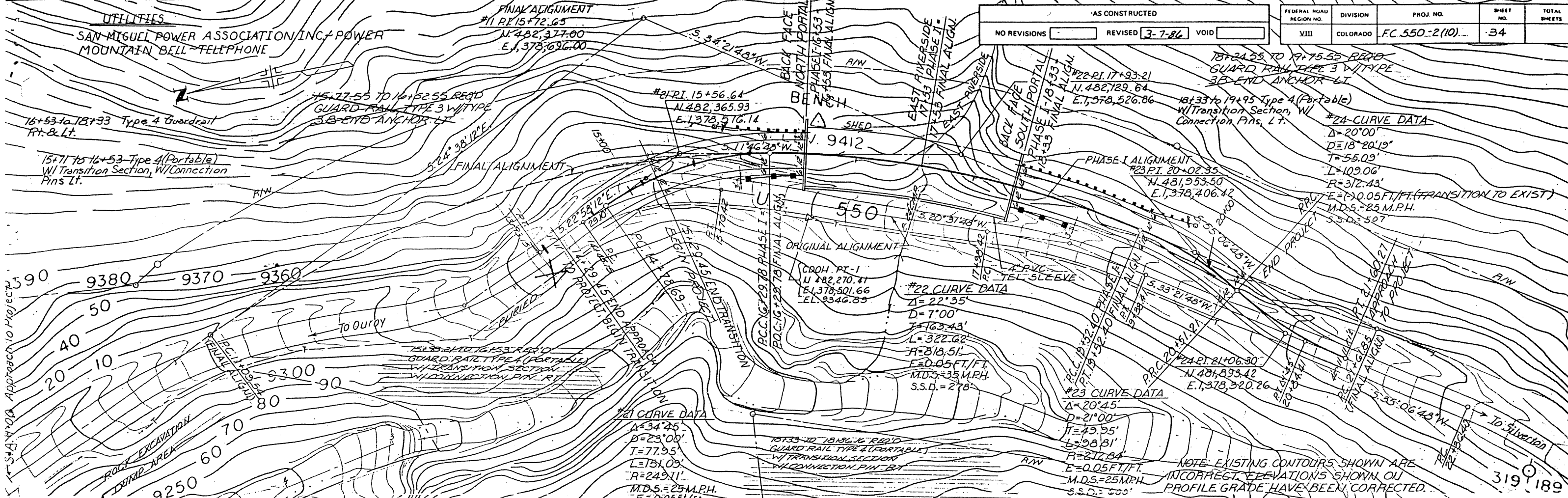

AS CONSTRUCTED		
NO REVISIONS	REVISED 3-7-86	VOID

FEDERAL ROAD REGION NO.	DIVISION	PROJ. NO.	SHEET NO.	TOTAL SHEETS
VIII	COLORADO	FC 550-2(10)	34	

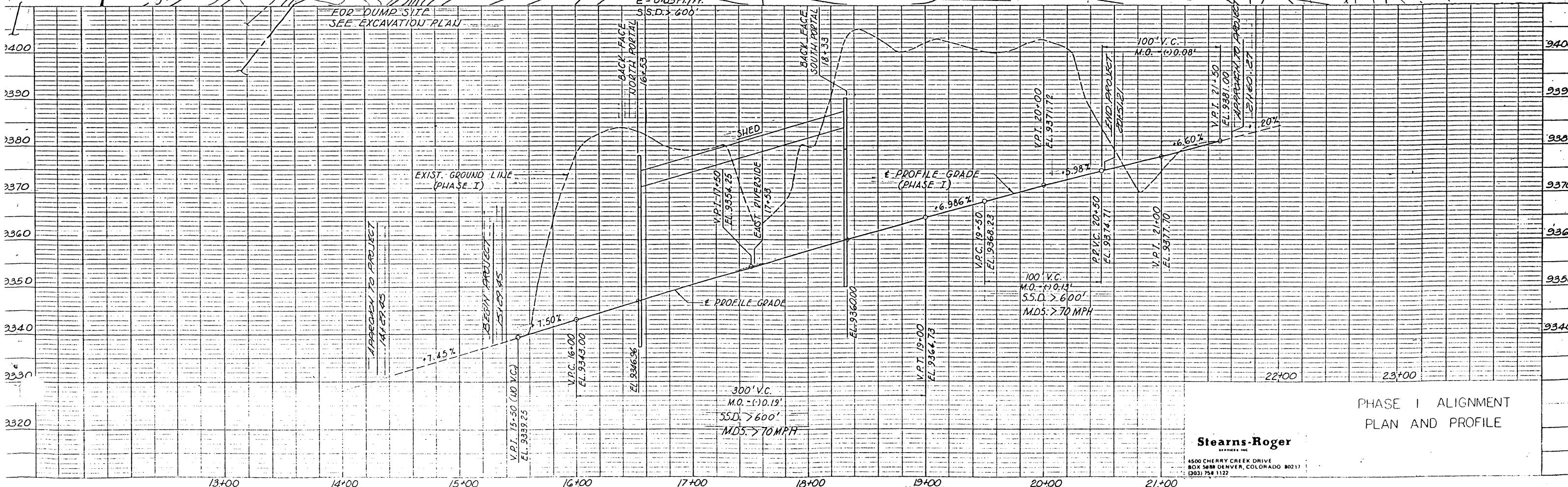

B2. East Riverside Snow shed (Proposed)

3 pages with plan and cross sections diagrams for the proposed Phases 1-3 structures.

Source: Stearns-Rogers/Colorado Division of Highways Plan and Profile of Proposed Federal Aid Project No. FC550-2(10).

AS CONSTRUCTED		
NO REVISIONS	REVISED 3-7-86	VOID

FEDERAL ROAD REGION NO.	DIVISION	PROJ. NO.	SHEET NO.	TOTAL SHEETS
VIII	COLORADO	FC550-2(10)	18	

REVISIONS	

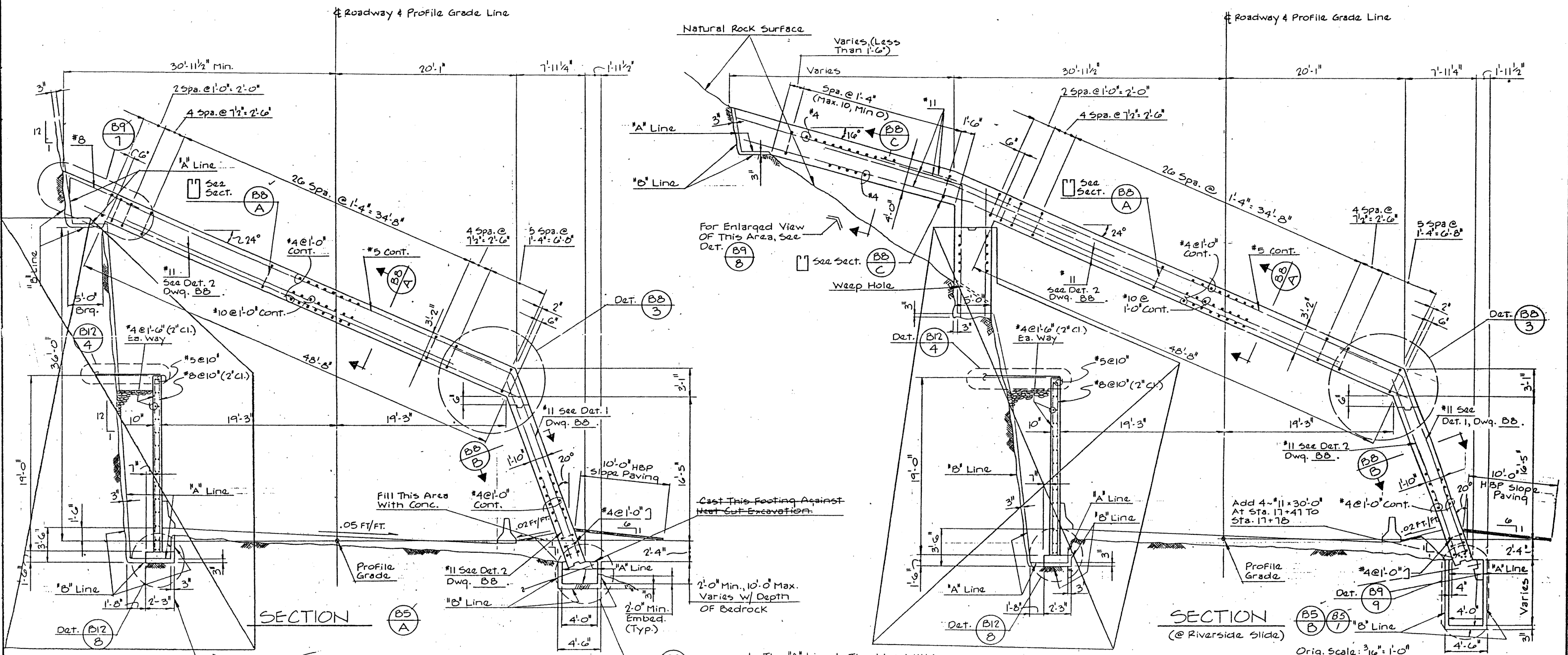

NOTE: See Sheet No. 18AX For Inside WALL Details.

1. The "A" Line Is The Line Within Which Excavated Material OF Any Kind Will Not Be Permitted To Remain. The "B" Line Is The Outside Limit To Which Measurement For Payment Will Be Made.
2. Over Excavation Beyond The "B" Line Will Be Filled With Concrete Or As Otherwise Directed By The Engineer, At The Expense OF The Contractor.
3. Column And Roof Shall Be Shored Until Roof Has Reached Design Strength.
4. All Concrete For Structure OF Snowshed Shall Be Class D (Bridge).

Stearns-Roger
 4500 CHERRY CREEK DRIVE
 BOX 5888 DENVER, COLORADO 80217
 (303) 758-1122

DIVISION OF HIGHWAYS			
PHASE I			
TYPICAL SECTIONS			
Designer	D. WEIR	Structure Numbers	M-06-A6
Detailer	B. KAZILEK		
Drawing Number B7		of 18 Drawings	

AS CONSTRUCTED
 NO REVISIONS REVISED 3-7-86 VOID

FEDERAL ROAD REGION NO.	DIVISION	PROJ. NO.	SHEET NO.	TOTAL SHEETS
VIII	COLORADO	FC 550-2(10)	28	

REVISIONS	

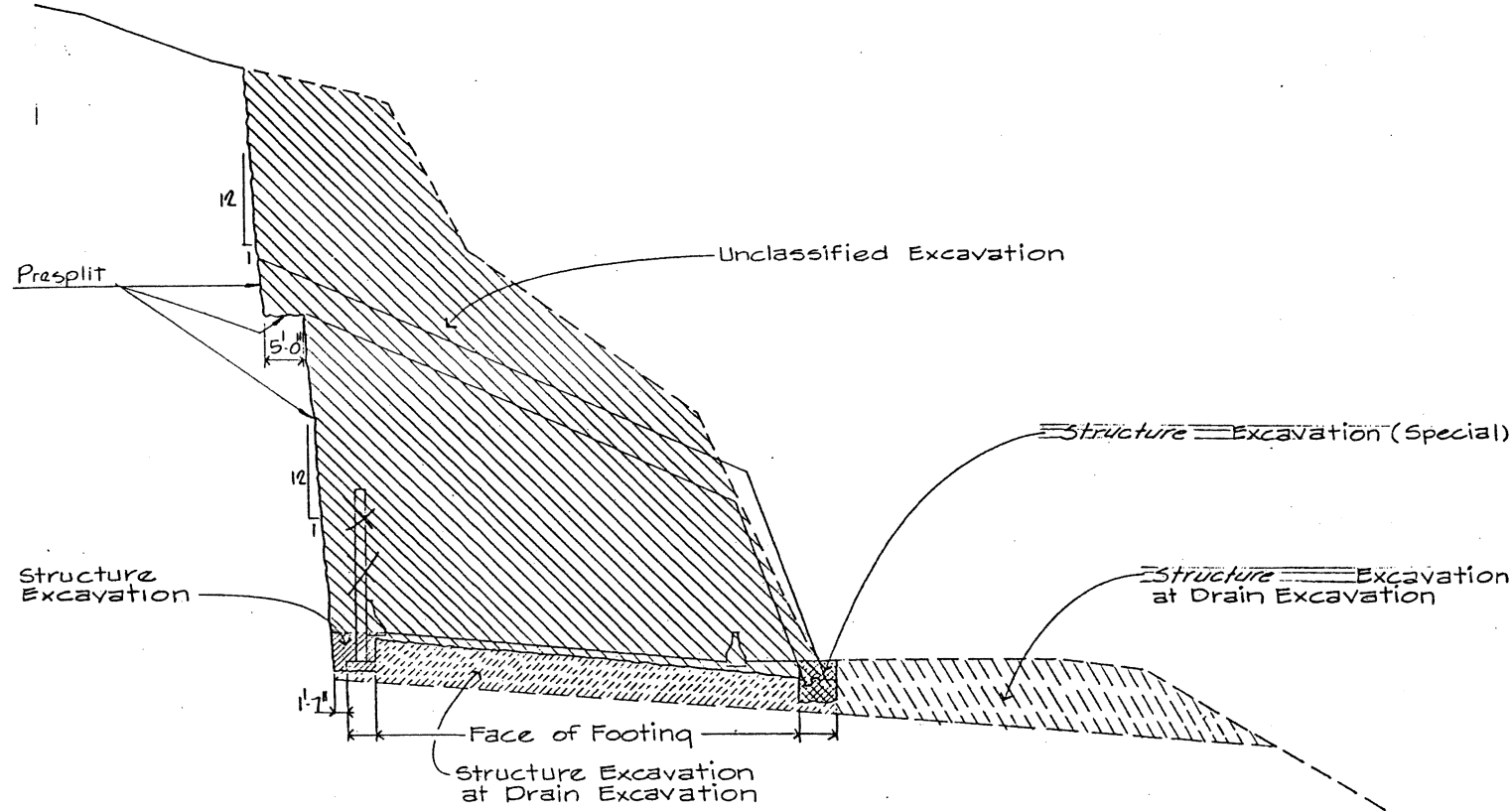

SECTION SHOWING EXCAVATION AT STRUCTURE

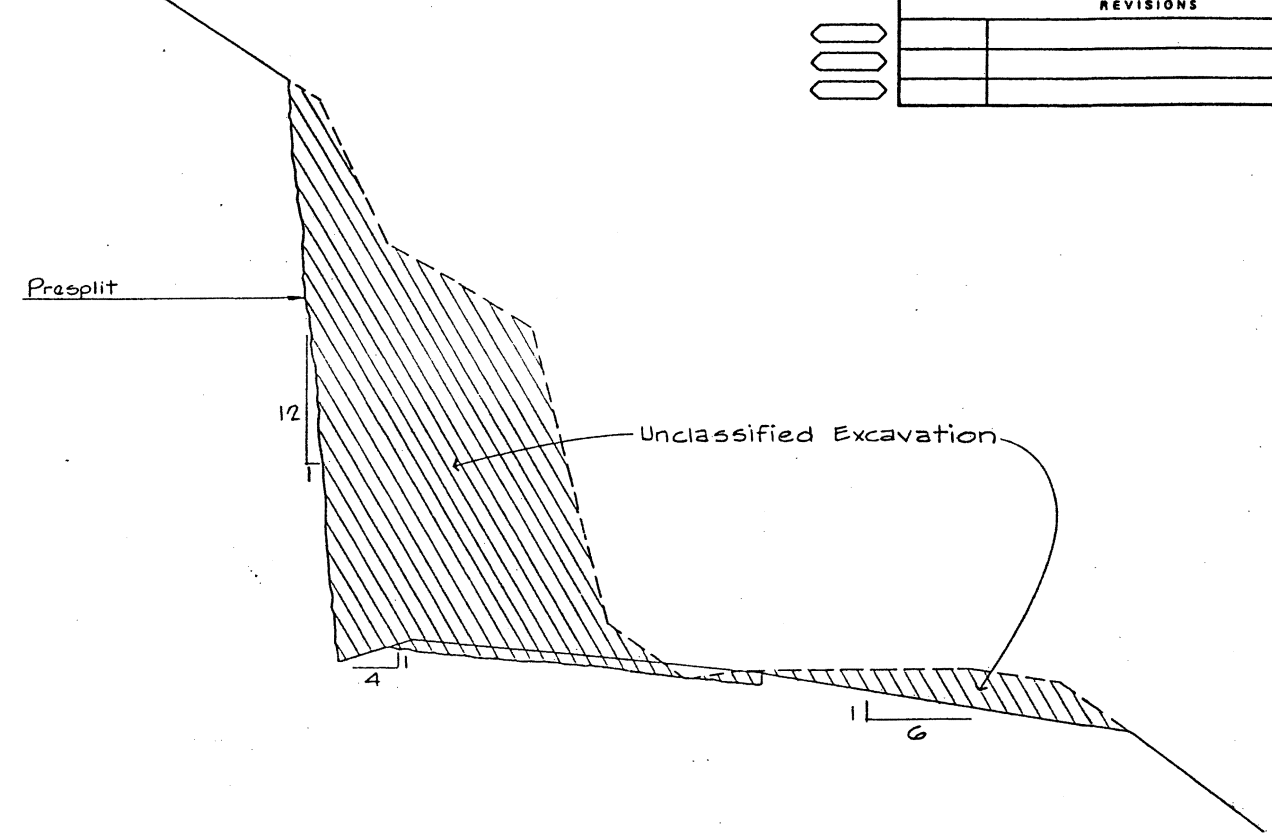

SECTION SHOWING EXCAVATION BEYOND STRUCTURE

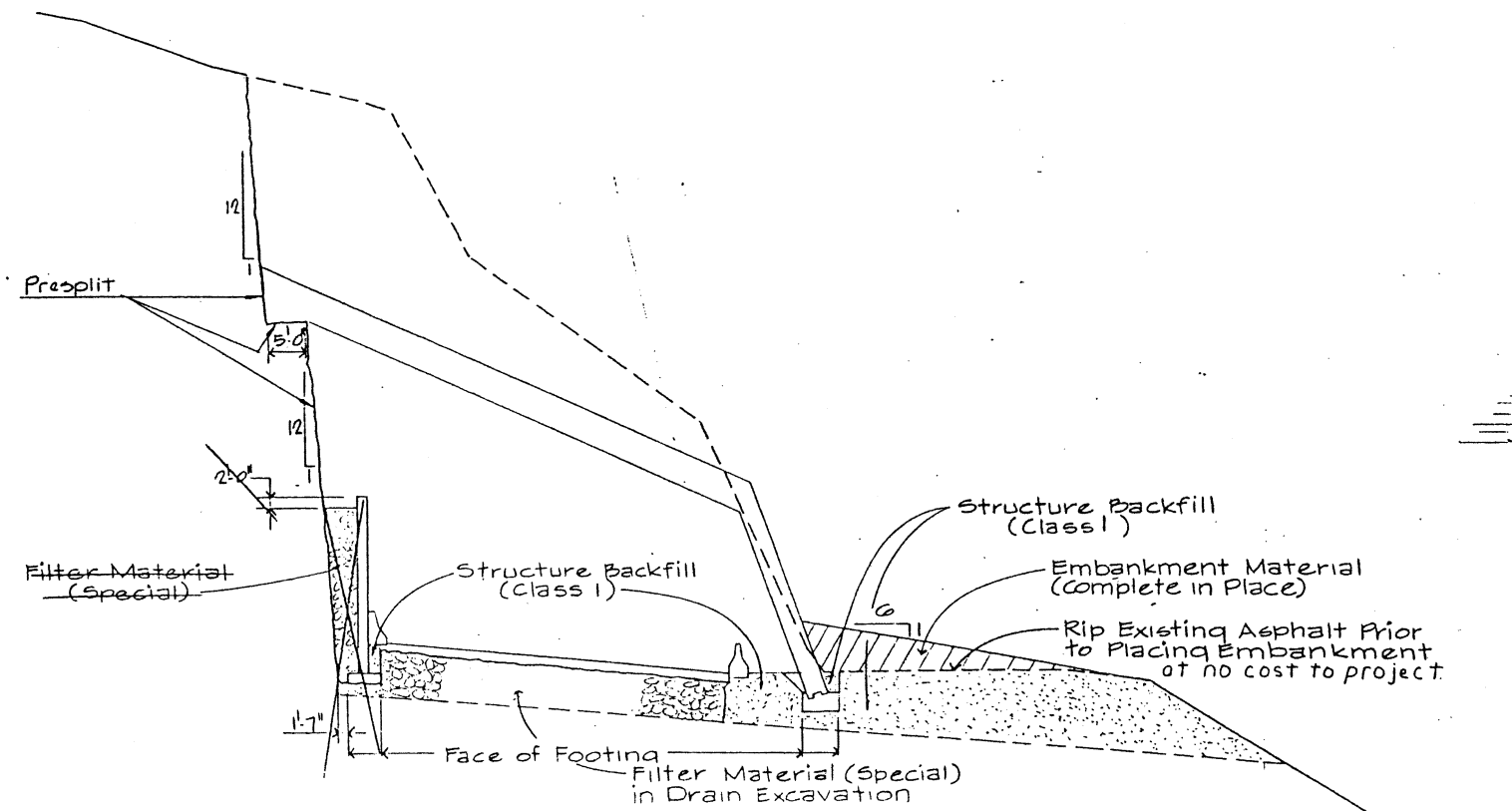

SECTION SHOWING BACKFILL AT STRUCTURE

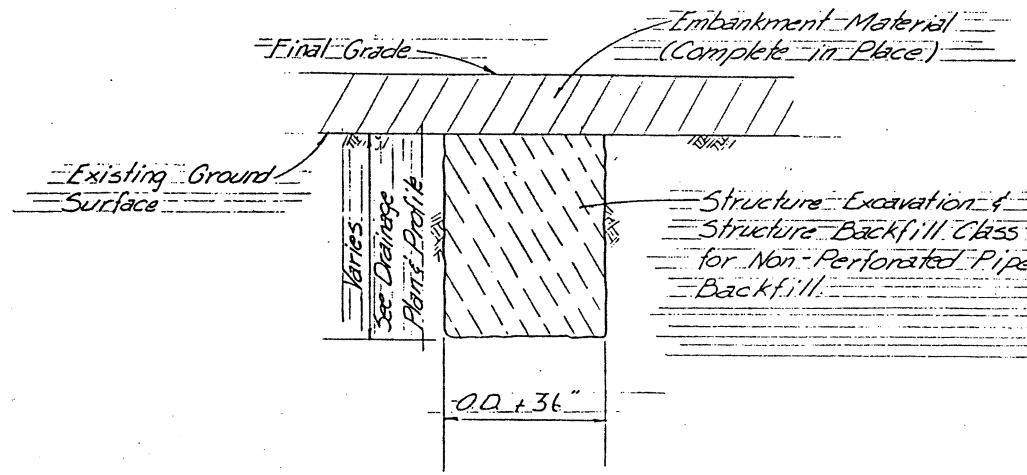

SECTION SHOWING EXCAVATION AND BACKFILL IN DRAIN TRENCH FOR NON-PERFORATED PIPE

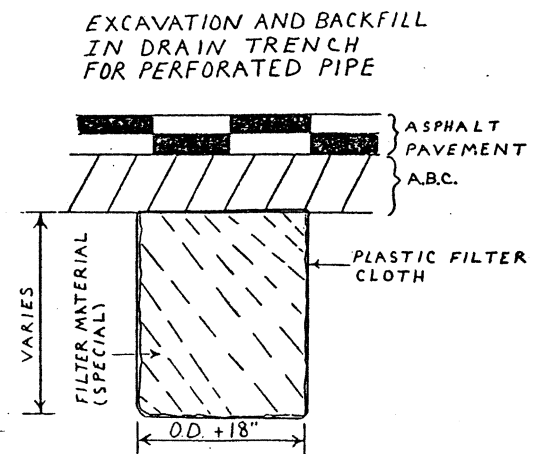

DIVISION OF HIGHWAYS

PHASE I
 EXCAVATION & BACKFILL SECTIONS

Designer P. WEIR	Structure Numbers M-06-AG
Detailer M.H.	
Drawing Number B 17	of 18 Drawings

Stearns-Roger
 4500 CHERRY CREEK DRIVE
 BOX 5888 DENVER, COLORADO 80217
 (303) 758-1122

DRAWING BY M.H. 9-5-84 CHECKED BY P.D.B. 1-8-85

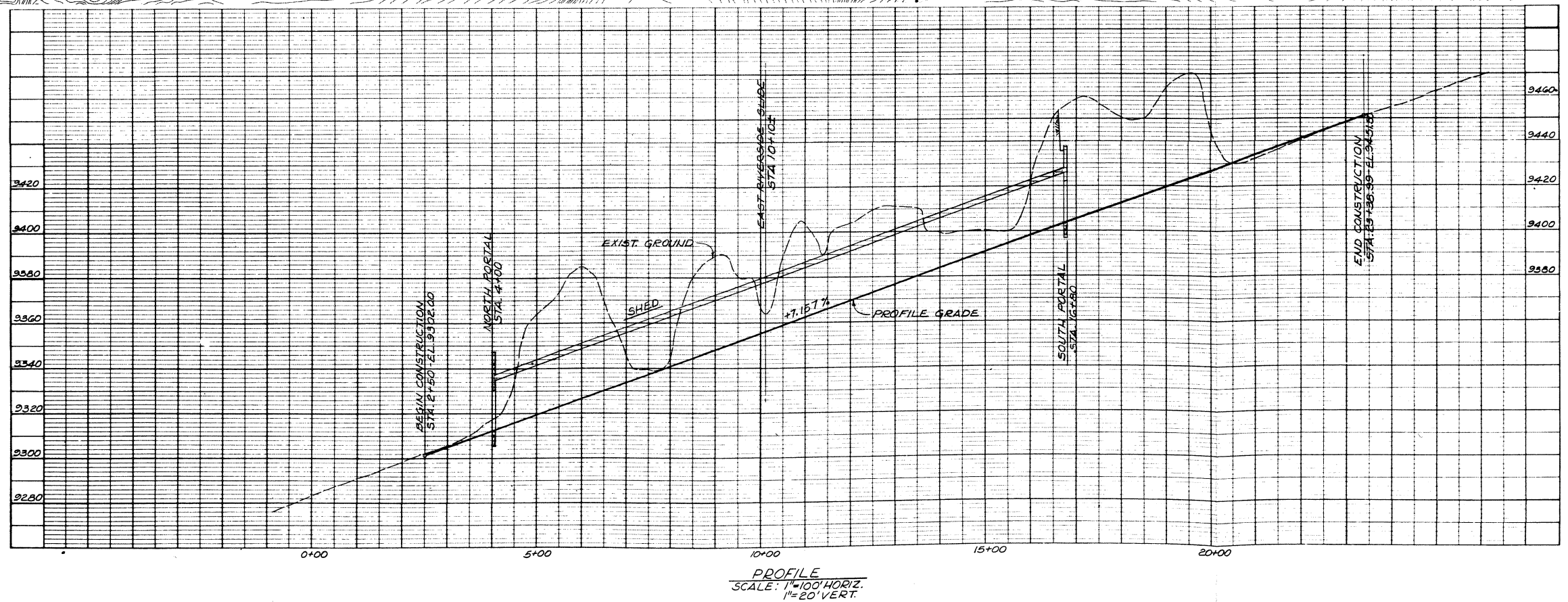
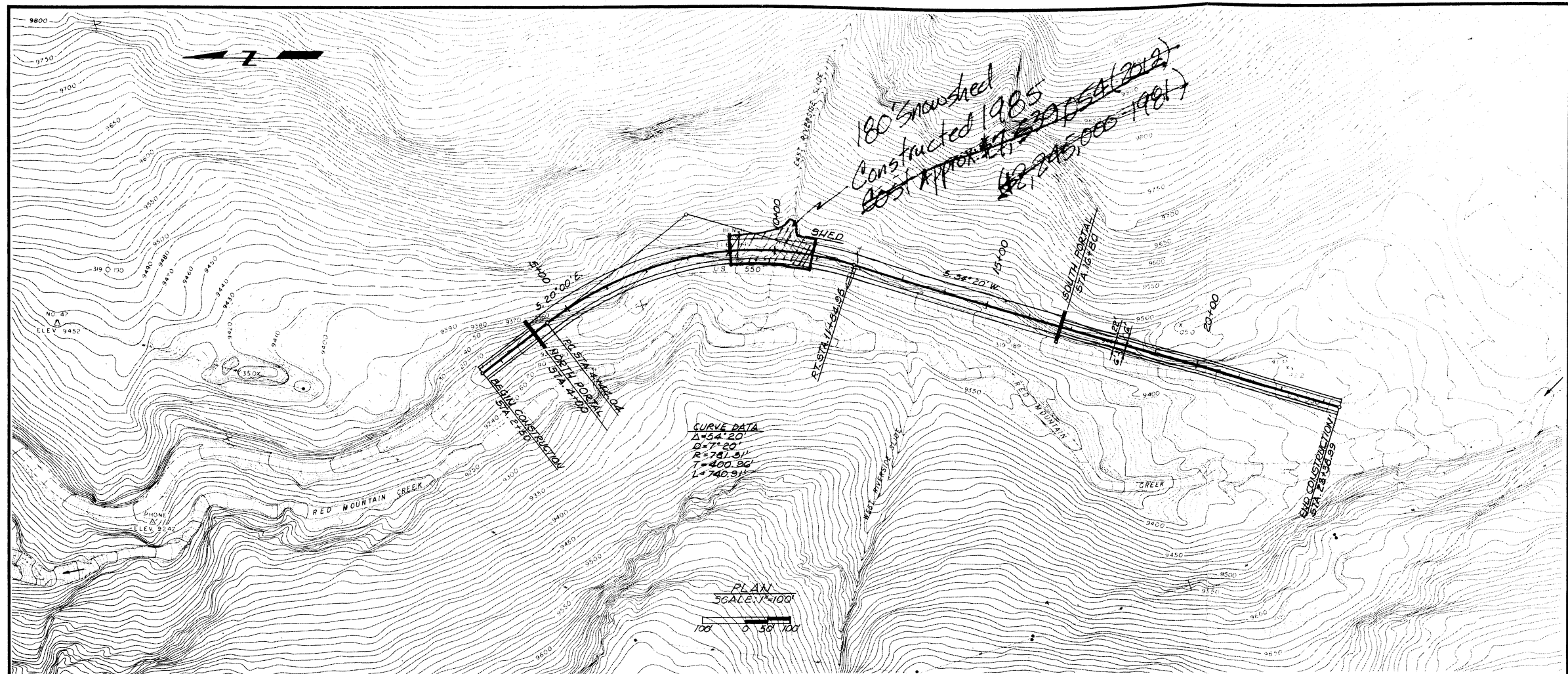

Appendix C – Utah DOT

This appendix contains the details on the proposed snow sheds on US-189 in Provo Canyon and SR-210 in Little Cottonwood Canyon.

C1. Proposed Dam Chute Snow Shed on US-189 in Provo Canyon

1 page with proposed cross section diagram.

Source: Parsons Brinckerhoff (2003)

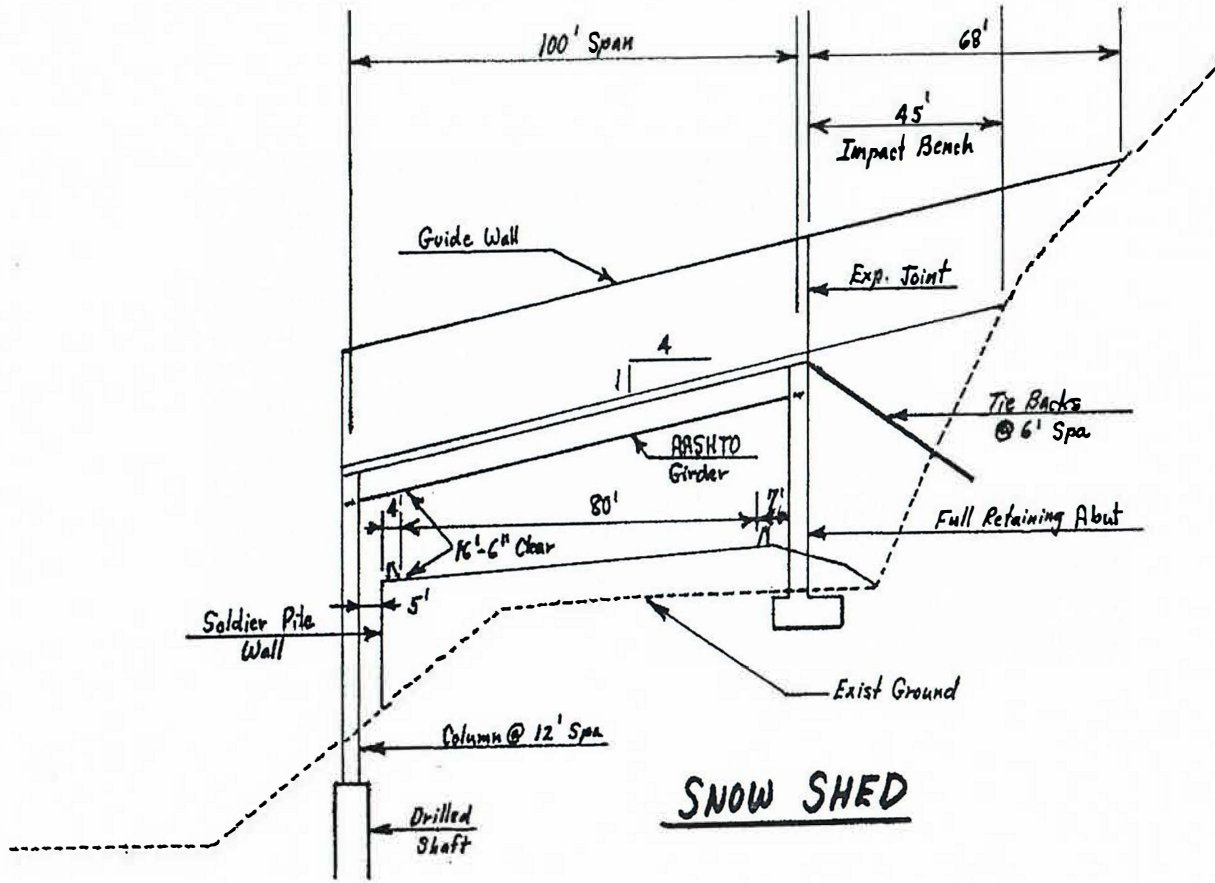

10/20/2018 10:00 AM

C2. Proposed Snow Sheds on SR-210 in Little Cottonwood Canyon

3 pages with plan and cross sections diagrams.

Source: Dynamic Avalanche Consulting Little Cottonwood Canyon (SR-210) Environmental Impact Statement: Snow Avalanche Hazard Improvement Options Report; HDR memorandum to Utah Department of Transportation

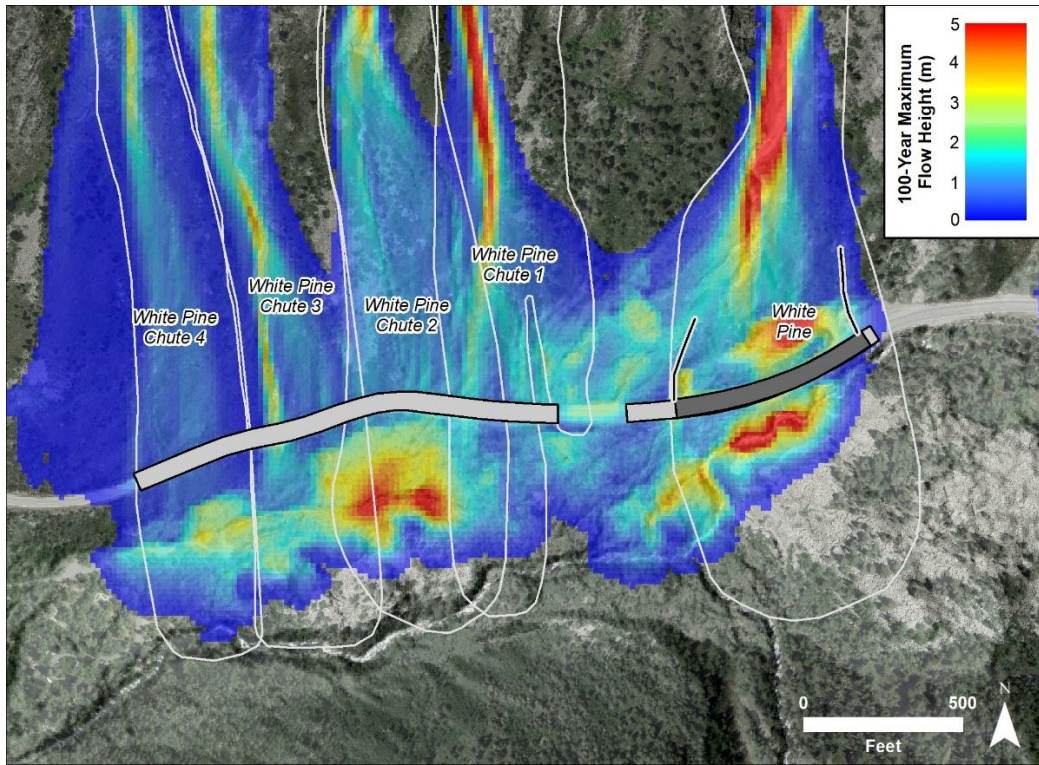

Figure 1a: White Pine Chutes 1-4 and White Pine, RAMMS 100-year maximum flow heights (m), proposed snow sheds with guiding berms (dark grey) and lengths without guiding berms (light grey).

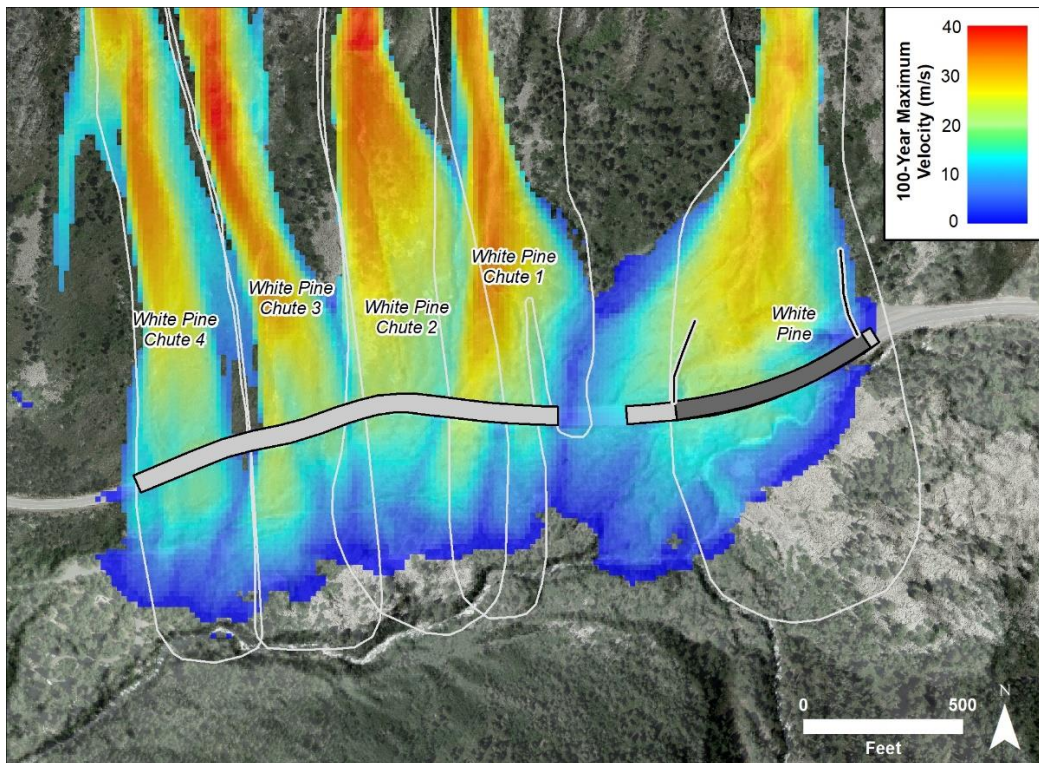

Figure 1b: White Pine Chutes 1-4 and White Pine, RAMMS 100-year velocity (m/s), and proposed sheds with guiding berms (dark grey) and lengths without guiding berms (light grey).

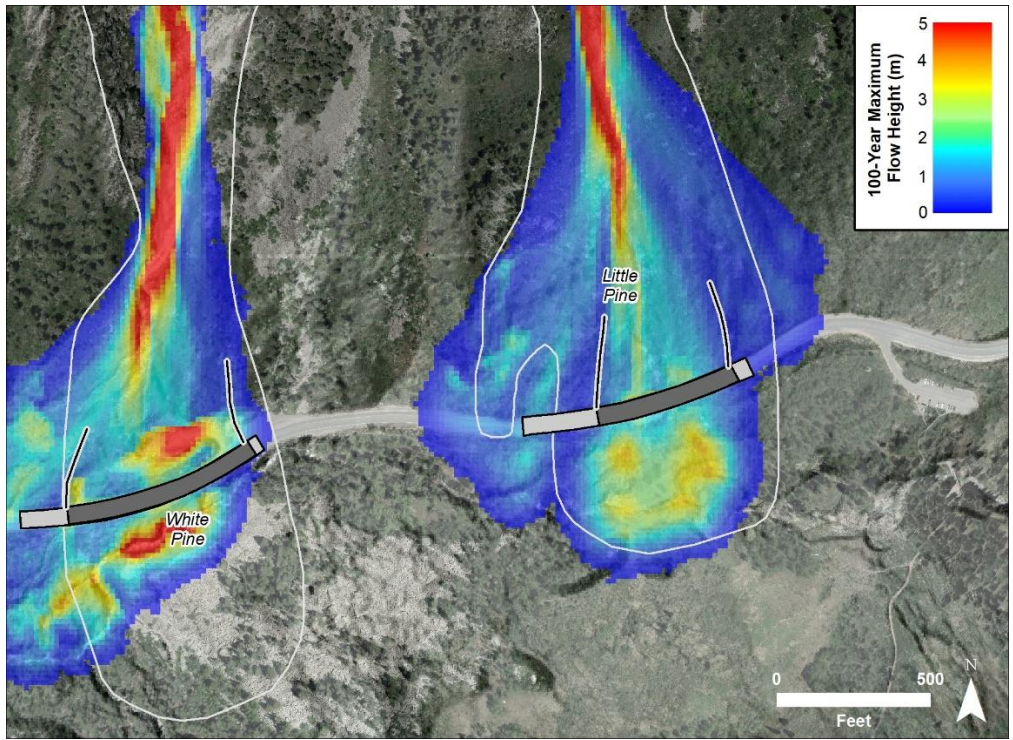

Figure 2a: Little Pine RAMMS 100-year maximum flow heights (m), proposed snow shed with guiding berms (dark grey) and length without guiding berms (light grey).

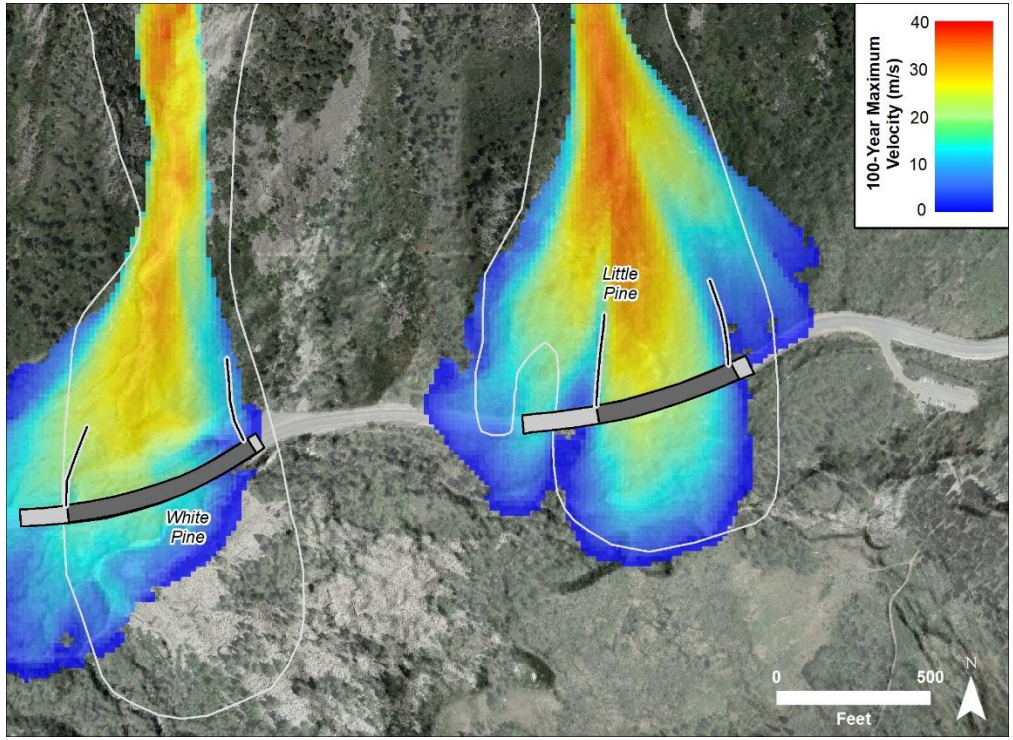
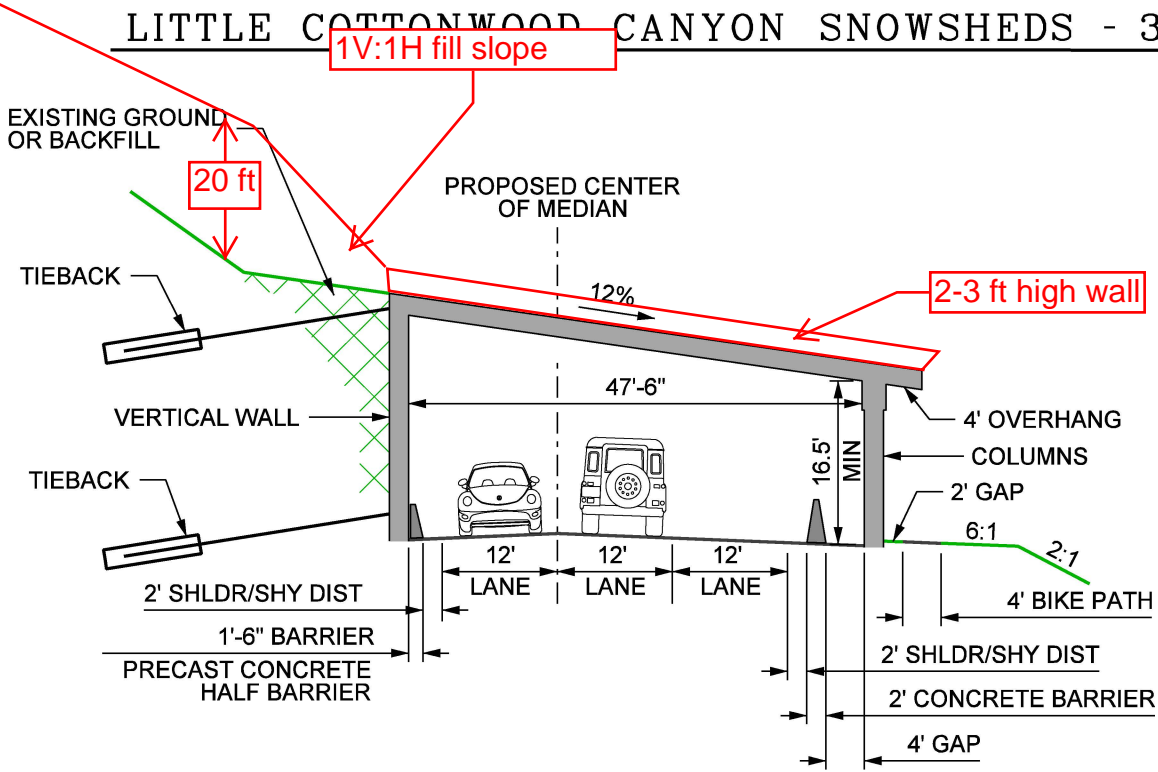

Figure 2b: Little Pine RAMMS 100-year velocity (m/s), proposed snow shed with guiding berms (dark grey) and length without guiding berms (light grey).

LITTLE COTTONWOOD CANYON SNOWSHEDS - 3 LANE



NOTE:

A 4' MINIMUM GAP ALLOWS FOR EGRESS AND MAINTENANCE ACCESS IN THE TUNNEL AND FROM UDOT STANDARD BA-1E, ELIMINATES THE NEED FOR THE COLUMNS TO BE DESIGNED FOR CRASH IMPACTS.

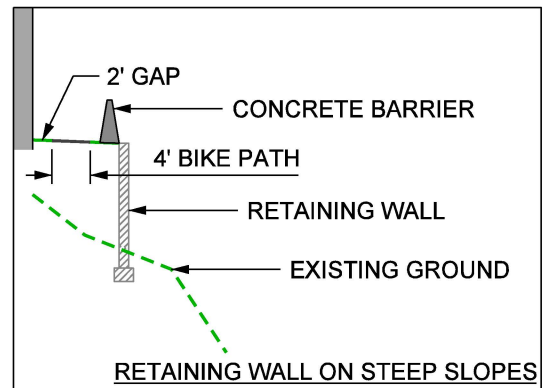

Appendix D – Washington DOT

This appendix contains the details on the proposed snowshed (2011) on Keechelus Lake, and historical snow sheds (1951, 1931) on I-90 on Snoqualmie Pass

D1. Proposed Keechelus Dam Snow Shed (Proposed 2011, not built)

3 pages with plan, elevation, loading diagrams, and cross-section drawings. Source: WSDOT engineering plans for I-90 Snowshed to Keechelus Dam Phase 1C- Replace Snowshed and Add Lanes (Volume 6 of 8).

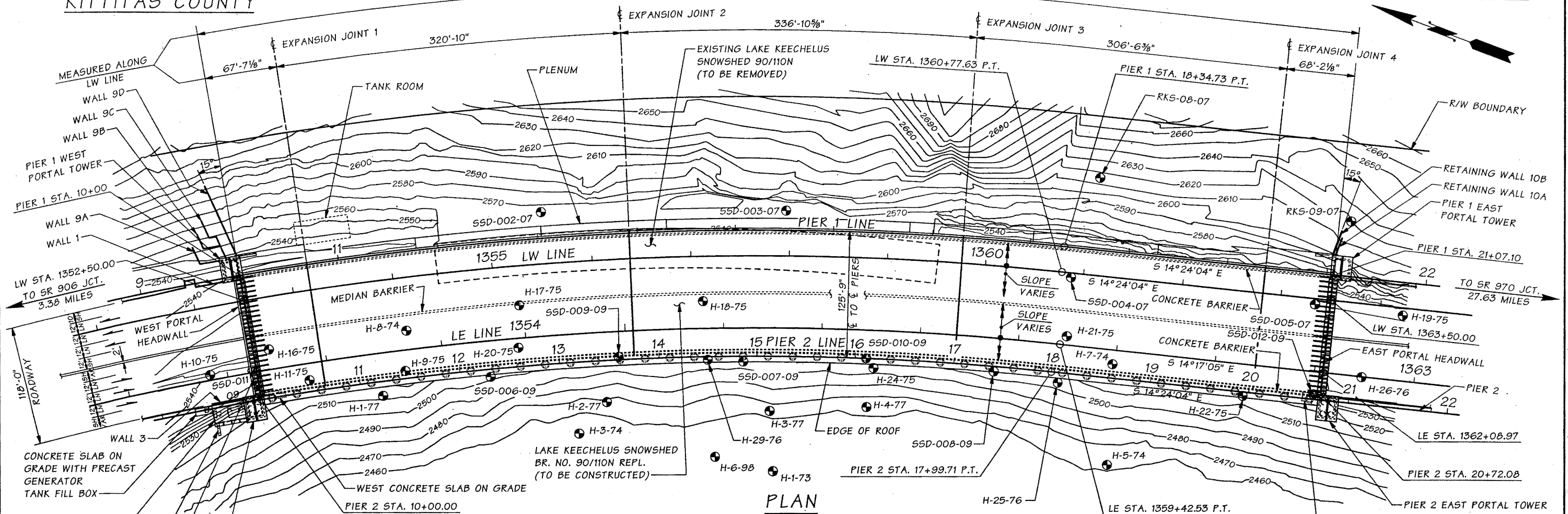

PLAN
 WEST PORTAL BEARING IS NORMAL TO LW LINE.
 EAST PORTAL BEARING IS NORMAL TO LW LINE.
 (WORK BENCH ARG, TEMPORARY SOIL NAIL WALL 4, DRAINAGE, AND ELECTRICAL, MECHANICAL SYSTEMS AND PIER 2 PLATFORMS NOT SHOWN FOR CLARITY)

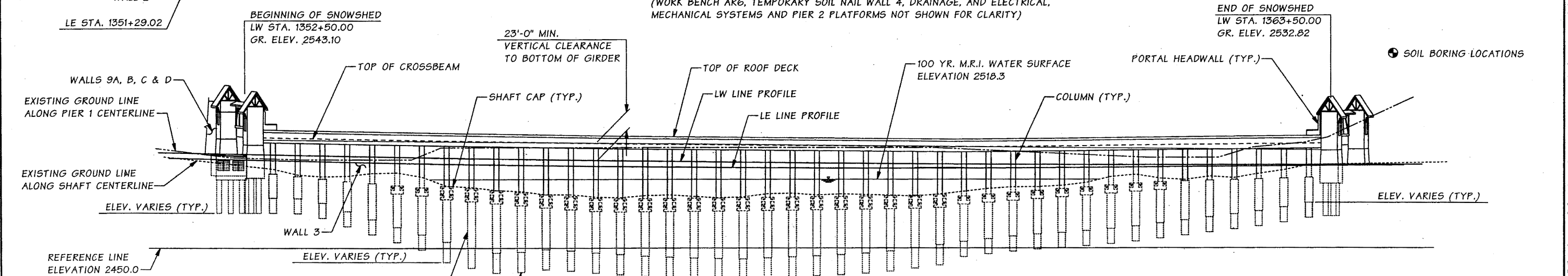

ELEVATION
 GRADE ELEVATIONS SHOWN ARE FINISH GRADES AT TOP OF ROADWAY SLAB ON LW LINE AND ARE EQUAL TO PROFILE GRADE.

P.C. GIRDERS (WF83G)
1450 PSF AVALANCHE LOAD

SR 90 FILE NO. 7268 SHEET BG100

DATUM
 NAVD 1988

Bridge Design Engr.	Kha Teghi, B	M:\X-Team\I-90 SNOWSHED VIC PH 1C\SNOWSHED\BR 90-110N\window files\01 LAYOUT.WND
Supervisor	Stoddard, RB	
Designed By	LHT/JB/ALP/DS	10/10
Checked By	LHT/JB/ALP/DS	03/11
Detailed By	waldron, GA	12/10
Bridge Projects Engr.	Lewis, RA	11/09
Prelim. Plan By	Tran, L/Moore, T	11/09
Architect/Specialist	PDK/BA/GAW	02/11
DATE	REVISION	BY APPD

BRIDGE AND STRUCTURES OFFICE

3/21/11

JUGESH KAPUR
 PROFESSIONAL ENGINEER

Washington State Department of Transportation

I-90	BRIDGE SHEET NO.
SNOWSHED TO KEECHELUS DAM PHASE 1C - REPLACE SNOWSHED AND ADD LANES LAKE KEECHELUS SNOWSHED BR. NO. 90/110N REPL.	BG100
LAYOUT	SHEET 935 OF 1515 SHEETS

C.S. 1901 ~ PROJ. NO. XL2779D ~ SOUTH CENTRAL REGION ~ I-90 ~ MP 58.04 TO MP 58.25 ~ LAKE KEECHELUS SNOWSHED ~ BR. NO. 90/110N REPL.

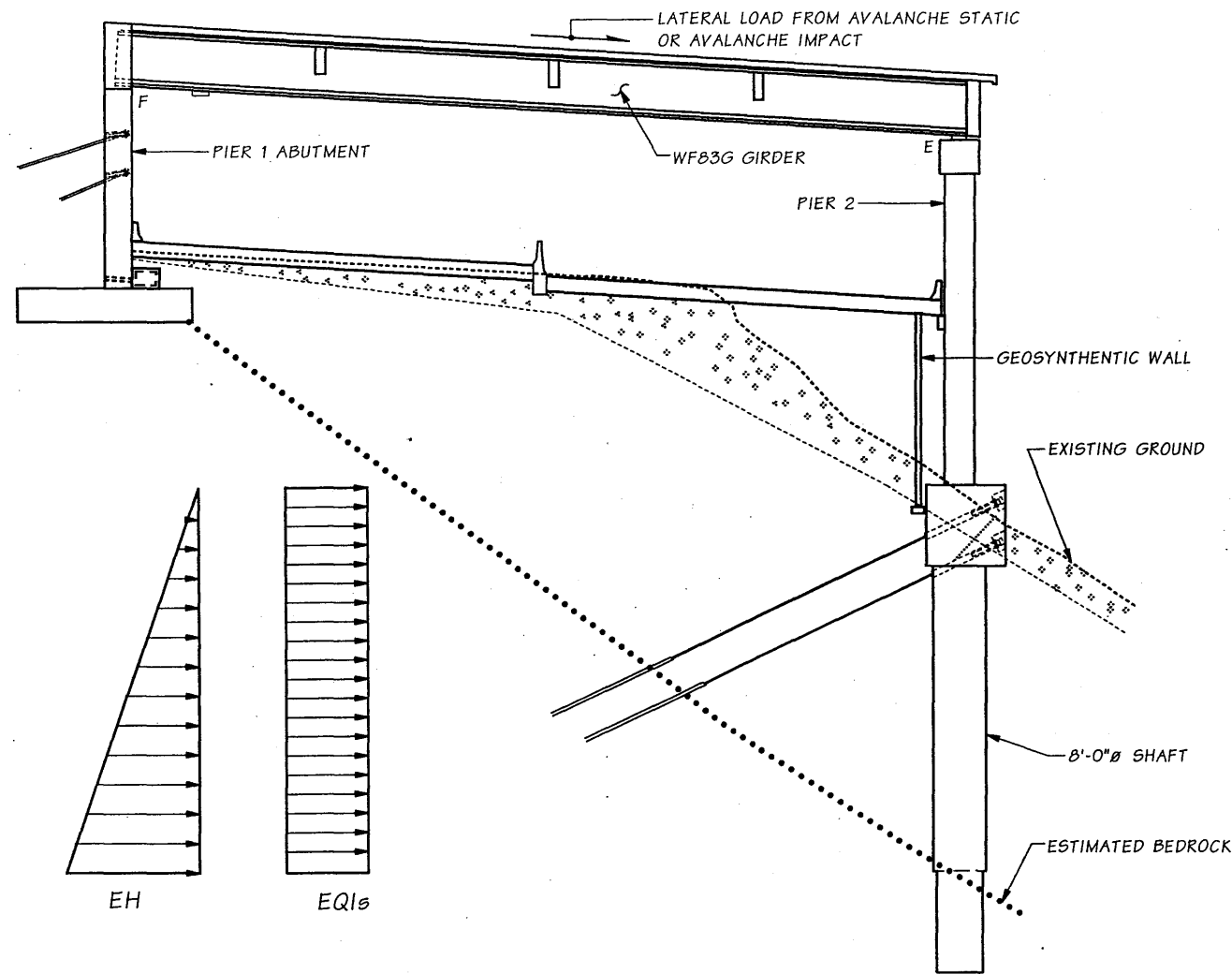
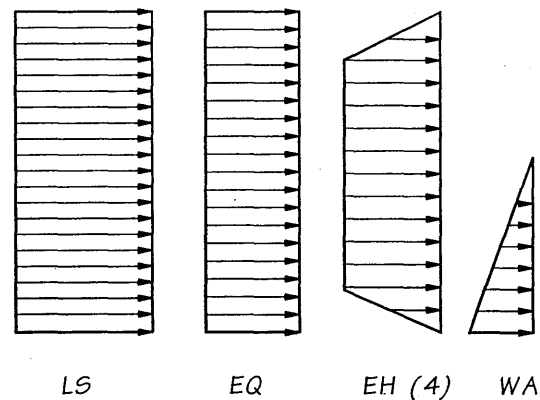
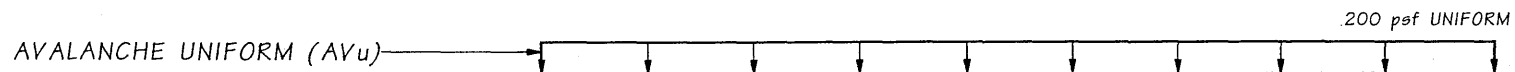
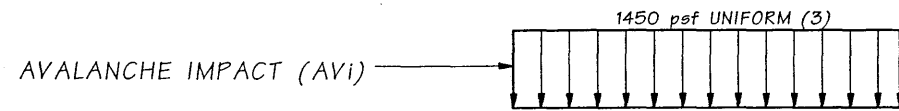
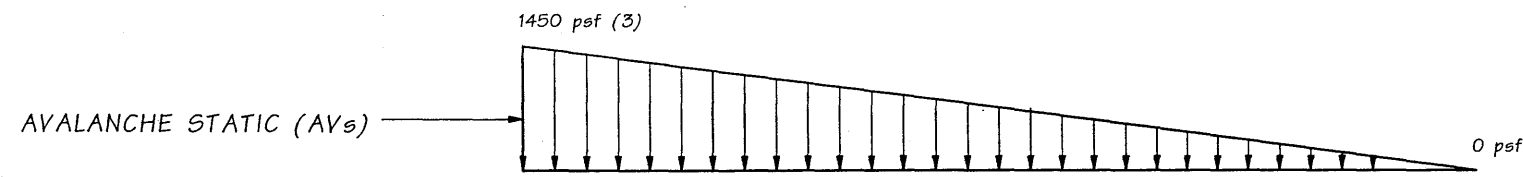

LOADING DIAGRAMS

FOR OTHER GEOMETRIC DATA AND CALL-OUT INFORMATION SEE TYPICAL SECTION ON BRIDGE SHEET BG126.

MODIFIED LOAD COMBINATIONS

THE LAKE KEECHELUS SNOWSHED REPLACEMENT HAS BEEN DESIGNED WITH THE MODIFIED LIMIT STATES SHOWN BELOW:

STRENGTH IA = $\gamma_p DC + 1.25 AV_{s1} + 1.25 AV_u + 1.0 EQ + 1.50 LS + 1.50 EH + 1.0 WA$

STRENGTH IB = $\gamma_p DC + 1.25 AV_{s1} + 1.25 AV_u + 1.25 AV_{i1} + 1.50 LS + 1.50 EH + 1.0 WA$

EXTREME I = $1.00 DC + 1.00 AV_i + 1.00 AV_u + 1.00 EQ$

EXTREME IIA = $\gamma_p DC + 1.25 AV_{s2} + 1.25 AV_u + 1.0 EQ_{ls} + 1.50 LS + 1.50 EH + 1.0 WA$

EXTREME IIB = $\gamma_p DC + 1.25 AV_{i2} + 1.25 AV_u + 1.0 EQ_{ls} + 1.50 LS + 1.50 EH + 1.0 WA$

SERVICE = $1.00 DC + 1.00 AV_{s1} + 1.00 AV_u + 1.00 LS + 1.00 EH + 1.0 WA$

- DC = WEIGHT OF SUPERSTRUCTURE + CRUSH SURFACE BASE COURSE (5)
- AV_{s1} = AVALANCHE LOAD STATIC FOR SERVICE LOAD (1)
- AV_{s2} = AVALANCHE LOAD STATIC FOR EXTREME LOAD (1)
- AV_{i1} = AVALANCHE LOAD IMPACT FOR SERVICE (1)
- AV_{i2} = AVALANCHE LOAD IMPACT FOR EXTREME (1)
- AV_u = AVALANCHE LOAD UNIFORM (1)
- EQ_{ls} = SEISMIC LANDSLIDE (2)
- EQ = EARTHQUAKE EARTH PRESSURE (2)
- LS = AVALANCHE SURCHARGE (2)
- EH = EARTH PRESSURE (2)
- WA = HYDRO-STATIC PRESSURE

RESISTANCE FACTORS FOR EACH MODIFIED LIMIT STATES FOR SUPERSTRUCTURE AND SUBSTRUCTURE ARE GOVERNED BY THE AASHTO LRFD BRIDGE DESIGN SPECIFICATIONS AND FACTORS RECOMMENDED BY GEOTECHNICAL ENGINEERS FOR FOUNDATION.

LEGEND

- (1) LOADING FROM THE AVALANCHE REPORT.
- (2) LOADING FROM THE GEOTECHNICAL REPORT.
- (3) THE AV_s OF 1450 PSF SHOWN IS MAXIMUM LOADING, REDUCED LOADING HAS BEEN USED FOR SOME LOCATIONS PER AVALANCHE REPORT.
- (4) THE EH DIAGRAM SHOWN IS FOR THE PIER WALL WITH TIEBACKS, FOR WALL WITHOUT TIEBACK NORMAL TRIANGULAR DIAGRAM IS USED.
- (5) DEAD WEIGHT OF PORTAL HEAD WALL TO BE CARRIED BY FIRST THREE GIRDERS AT THE PORTALS.

SR 90 FILE NO. 7268 SHEET BG103

Bridge Design Engr.	Khaleghi, B	M:\X-Team\I-90 SNOWSHED VIC PH 1C\SNOWSHED\BR 90-110N\window files\03 LOADING DIAGRAM.WND			
Supervisor	Stoddard, RB	REGION NO.	STATE	FED. AID PROJ. NO.	SHEET NO.
Designed By	Tran, LH 03/11	10	WASH.		TOTAL SHEETS
Checked By	LHT/DS/JP/ALP 03/11	JOB NUMBER			
Detailed By	Andersen, JM 03/11	10Y01B			
Bridge Projects Engr.		DATE	REVISION	BY	APPD
Prelim. Plan By					
Architect/Specialist					



BRIDGE AND STRUCTURES OFFICE



I-90
SNOWSHED TO KEECHELUS DAM PHASE 1C -
REPLACE SNOWSHED AND ADD LANES
LAKE KEECHELUS SNOWSHED BR. NO. 90/110N REPL.

LOADING DIAGRAM

BRIDGE SHEET NO. BG103
SHEET 938 OF 1515 SHEETS

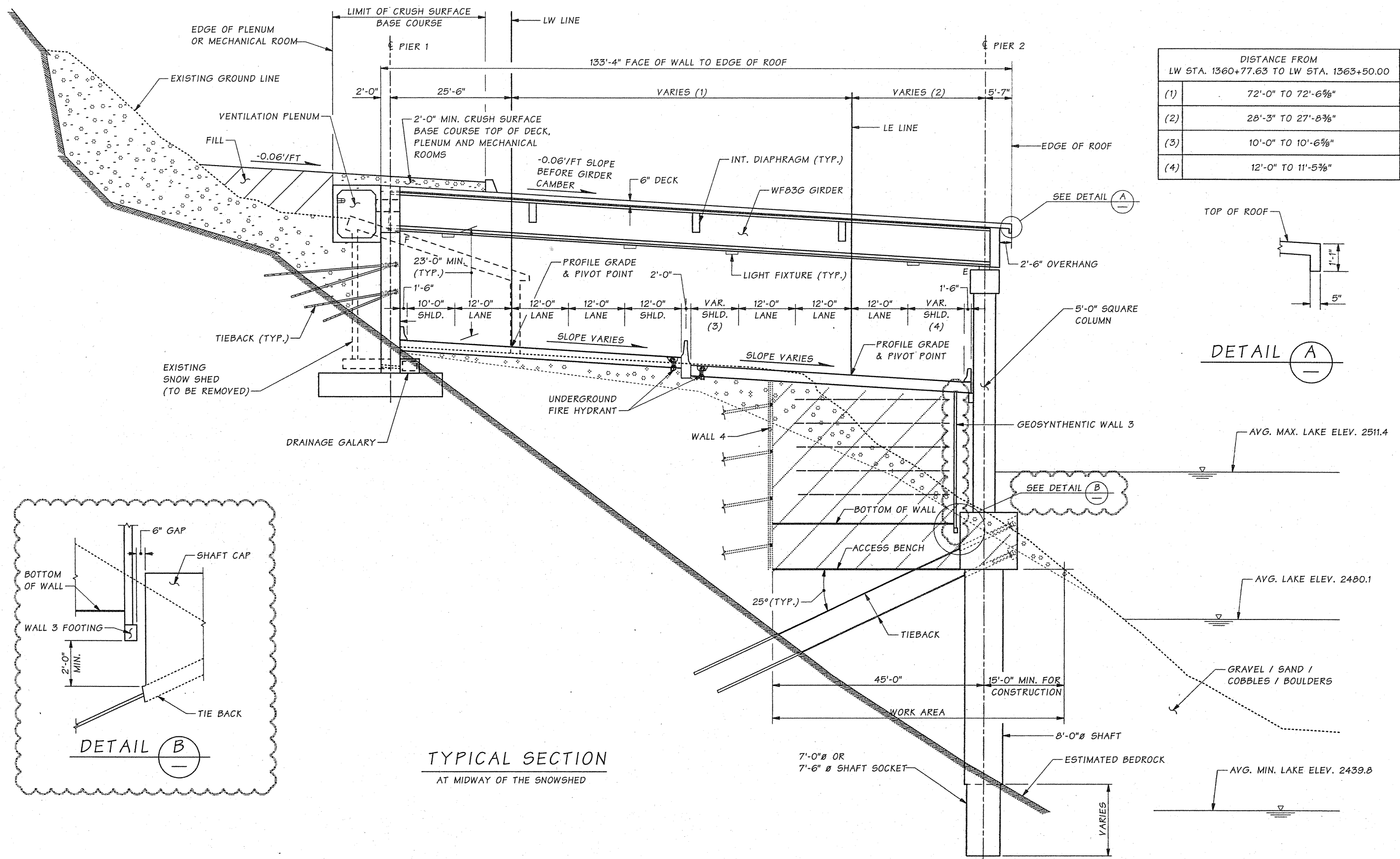

DISTANCE FROM LW STA. 1360+77.63 TO LW STA. 1363+50.00	
(1)	72'-0" TO 72'-6 3/8"
(2)	28'-3" TO 27'-8 3/8"
(3)	10'-0" TO 10'-6 3/8"
(4)	12'-0" TO 11'-5 3/8"

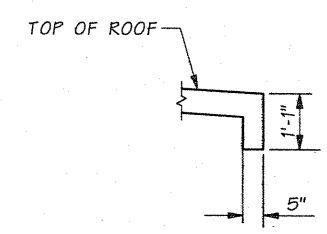

DETAIL A

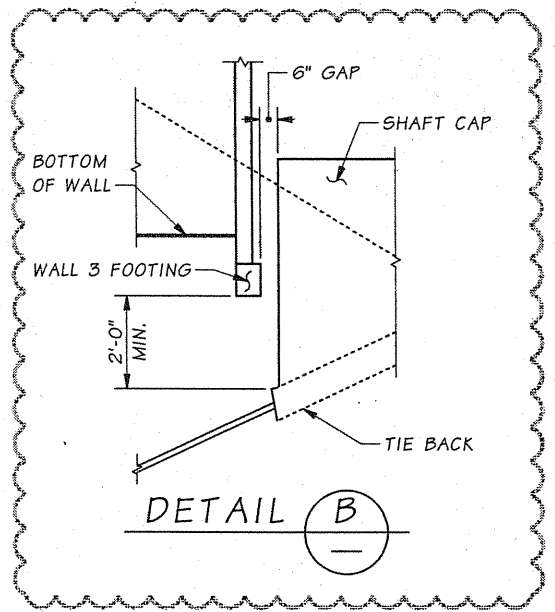

DETAIL B

TYPICAL SECTION
AT MIDWAY OF THE SNOWSHED

SR 90 FILE NO. 7268 SHEET BG126

Bridge Design Engr.	Khaleghi, B	M:\X-Team\I-90 SNOWSHED VIC PH 1C\SNOWSHED\BR 90-110N>window files\FRAMING_TYP. SECT 2.WND
Supervisor	Stoddard, RB	
Designed By	Tran, LH	09/10
Checked By	LHT/DS/JB/ALP	03/11
Detailed By	DJM/JMA	09/10
Bridge Projects Engr.		05/20/11 REVISED WALL 3 GEOMETRY, ADDED DETAIL LHT RBS
Prelim. Plan By		04/20/11 REVISED CALLOUTS, PARAPET, TITLE BLOCK DS RBS
Architect/Specialist		DATE REVISION BY APPD

BRIDGE AND STRUCTURES OFFICE

Washington State Department of Transportation

I-90
SNOWSHED TO KEECHELUS DAM PHASE 1C -
REPLACE SNOWSHED AND ADD LANES
 LAKE KEECHELUS SNOWSHED BR. NO. 90/110N REPL.

TYPICAL SECTION

BRIDGE SHEET NO. **BG126**
 SHEET **961**
 OF **1515**
 SHEETS

D2. Lake Keechelus Snow Shed (Built 1951)

4 pages with plan, elevation, cross-section, and framing detail drawings. Source: WSDOT engineering plans for Primary State Highway No. 2: Airplane Curve & Lk. Keechelus Snowsheds.

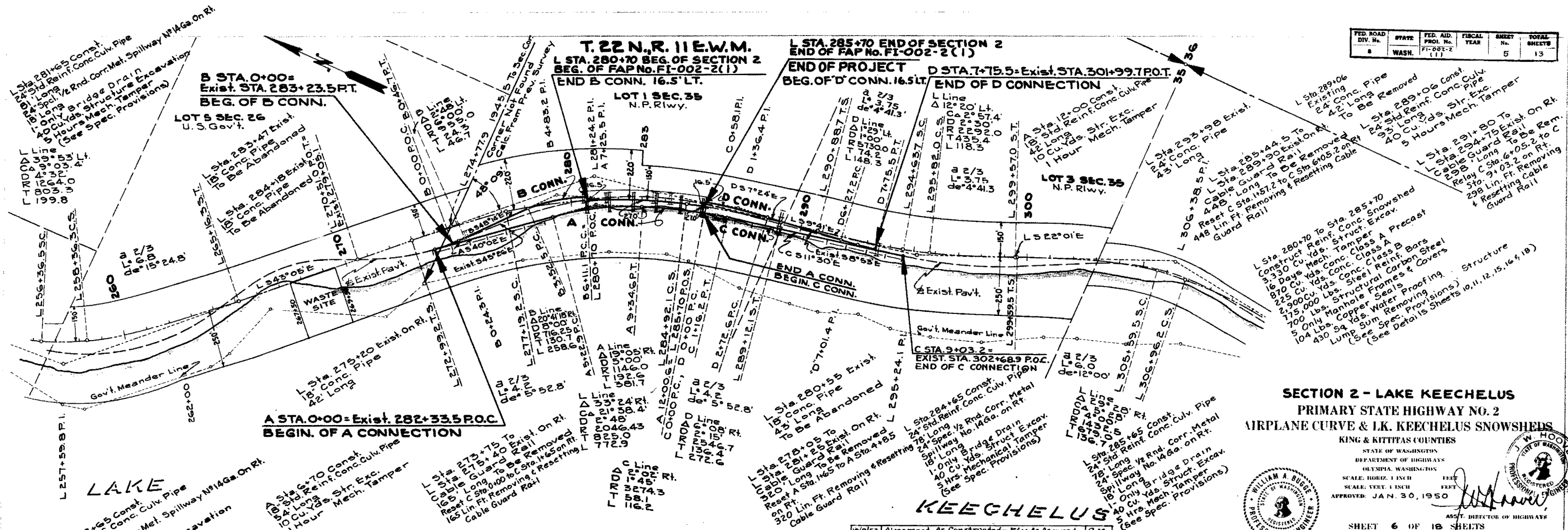

SECTION 2 - LAKE KEECHELUS
PRIMARY STATE HIGHWAY NO. 2
AIRPLANE CURVE & L.K. KEECHELUS SNOWSHEDS

KING & KITITAS COUNTIES
 STATE OF WASHINGTON
 DEPARTMENT OF HIGHWAYS
 OLYMPIA, WASHINGTON

SCALE: HORIZ. 1" = 100' FEET
 SCALE: VERT. 1" = 5' FEET
 APPROVED: JAN. 30, 1950

WILLIAM A. BURGE
 REGISTERED PROFESSIONAL ENGINEER

J. W. HOOKER
 REGISTERED PROFESSIONAL ENGINEER

ASST. DIRECTOR OF HIGHWAYS

SHEET 6 OF 18 SHEETS
 CONTRACT NUMBER 2734

DATE	BY
DRAWN	DIST. NO. 5
1950	1950
TRACED	S. Roseland
CHECKED	Jan. 50
LOC. ENGINEER	M. D. Mahan
DIST. ENGINEER	T. P. Doyle

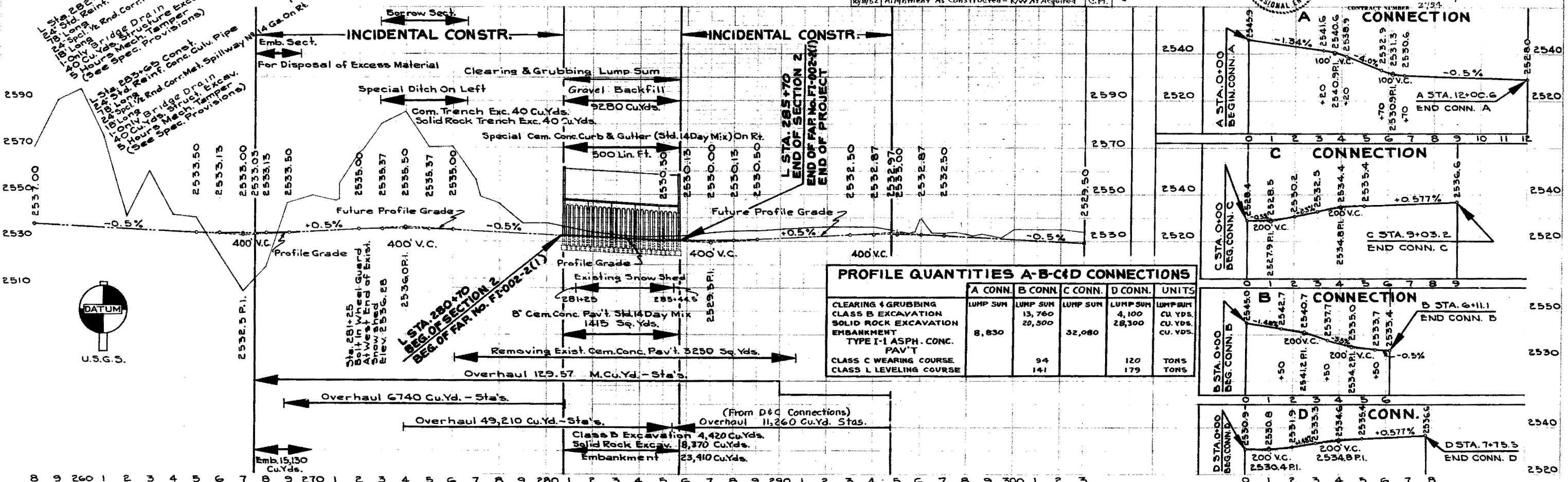

PROJ. NO.	DATE	SCALE	DATE	SCALE	DATE	SCALE
8	MARCH 23-03-20					

Note:
Profile grade shown is
Finished Grade.
Use 7% standard Super-elevation
Roadway crowned 1/2" per foot
on tangent. Crown eliminated on
curves by transition transition
between S.T. and C.S.

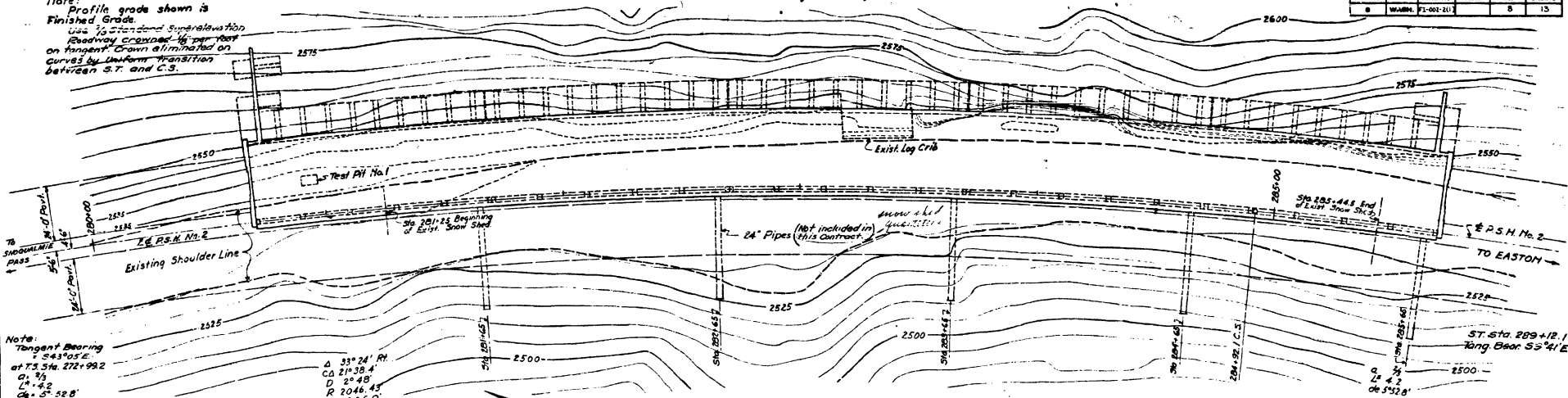

Note:
Tangent Bearing
= S43°05'E
at 75 Sta. 272+99.2
G. 1/4
L. 1/4
C. 5' 52.8'
S.C. Sta. 277+19.2

Δ 33°24' RH
CA 21°38.4'
D 2' 4.8"
R 2046.43
T 825.0
L 772.9'

EI 2532.8
EI 2534.1 Top of Ground

Grey Cemented Sand,
Gravel & Boulders

EI 2522.0

TEST PIT NO. 1

PLAN

Scale: 1"=20'-0"

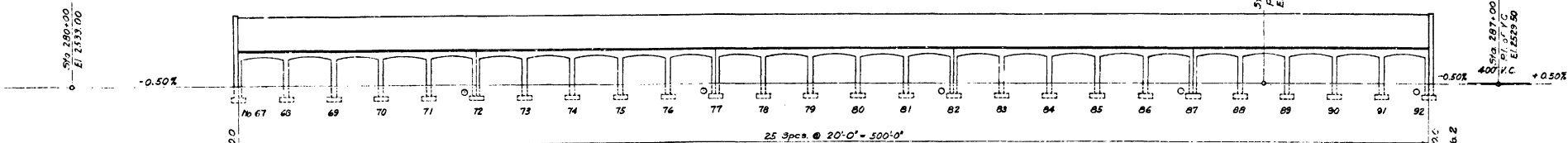

ELEVATION

(Developed along centerline)

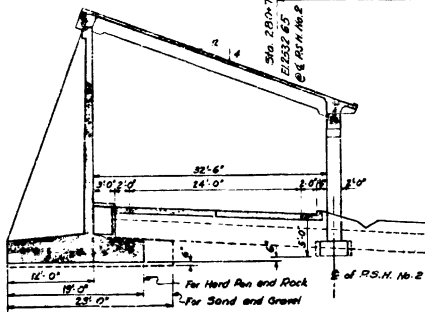

TYPICAL SECTION

PRIMARY STATE HIGHWAY NO. 2
AIRPLANE CURVE & LK. KEECHELUS SNOWSHEDS
RING & RITTAF CHARTER
LAYOUT - LK. KEECHELUS



STATE OF WISCONSIN
DEPARTMENT OF TRANSPORTATION
DIVISION OF HIGHWAYS
APPROVED: [Signature]
DATE: [Date]
SHEET NO. OF 12 SHEETS
CONTRACT NAME 3754

APPROVED: [Signature]

PROJ. NO.	STATE	FED. AID PROJ. NO.	FISCAL YEAR	DISTRICT NO.	TOTAL SHEETS
8	WASH.	17-021-111		7	11
		17-021-111		9	13

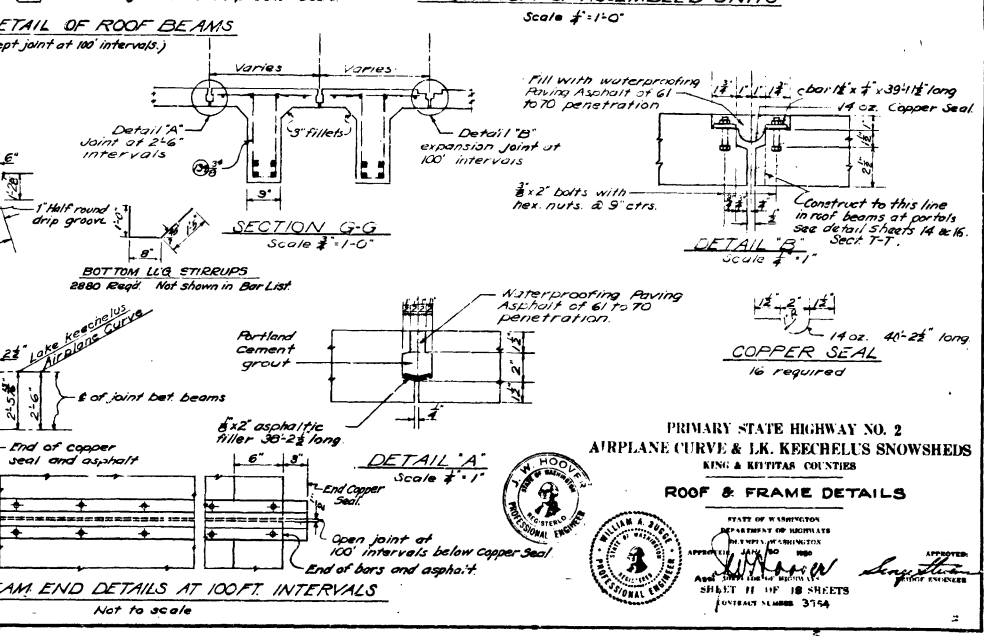
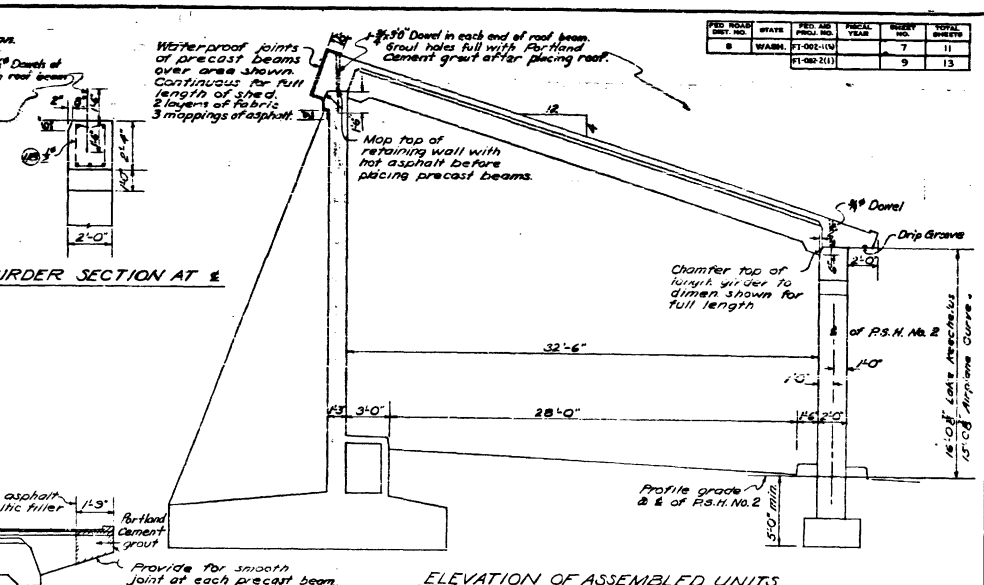
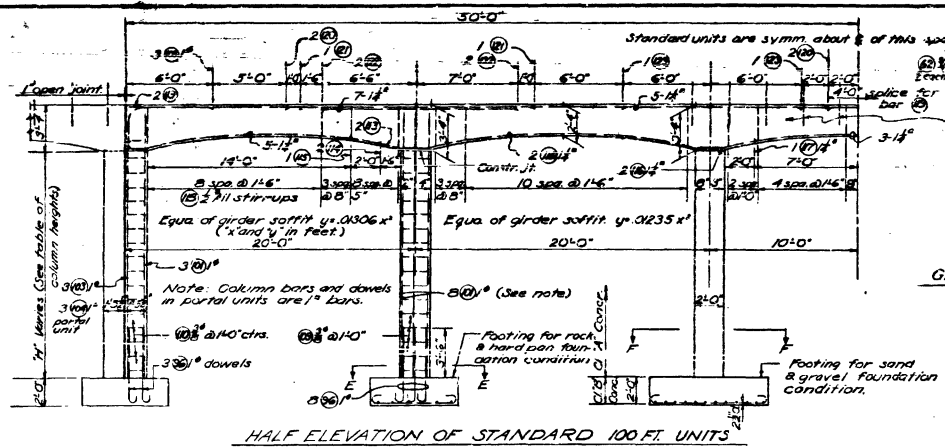

PRIMARY STATE HIGHWAY NO. 2
AIRPLANE CURVE & LK. KEECHELUS SNOWSHEDS
KING & RITZPAT COUNTIES

ROOF & FRAME DETAILS

STATE OF WASHINGTON
DEPARTMENT OF HIGHWAYS
DIVISION OF HIGHWAYS
APPROVED: [Signature]
DATE: 11/11/58
SHEET 11 OF 18 SHEETS
PROJECT NUMBER 3754

APPROVED: [Signature]
DATE: 11/11/58
SHEET 11 OF 18 SHEETS
PROJECT NUMBER 3754

FED. ROAD DIST. NO.	STATE	FED. AID PROJ. NO.	FISCAL YEAR	SHEET NO.	TOTAL SHEETS
4	WASH.	F1-002-2(1)		4	13

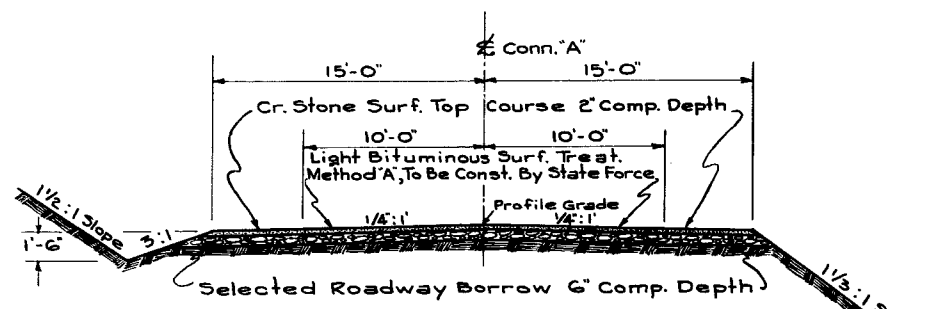

ROADWAY SECTION-A CONNECTION
 30' CRUSHED STONE SURFACING
 'A' STA. 0+00 To WEST PORTAL OF SNOWSHED - L STA. 280+70

Note: For Rdwy. Section-A Conn. West Portal of Snowshed to A. Sta. 12+00.6 See Section 2 - Roadway Section.

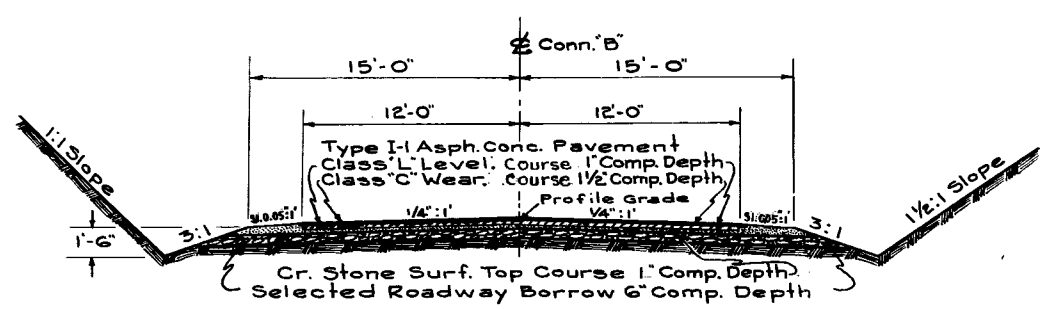

ROADWAY SECTION-B CONNECTION
 24' TYPE I-1 ASPH. CONC. PAVEMENT
 'B' STA. 0+00 To 'B' STA. 6+11.1

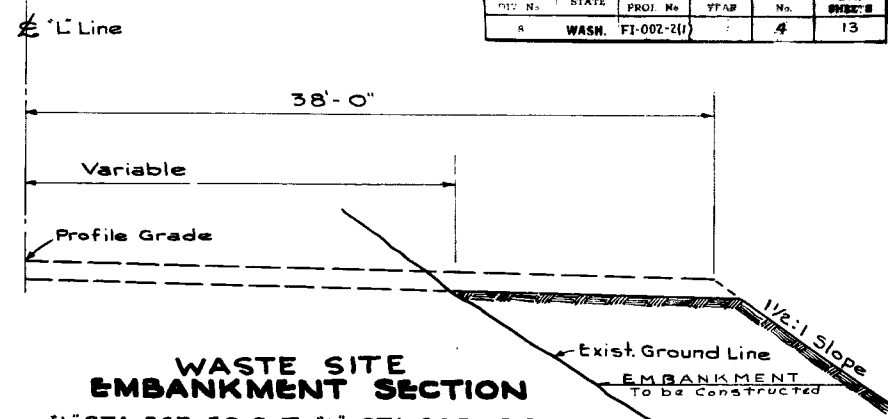

WASTE SITE EMBANKMENT SECTION
 'L' STA. 267+50.0 To 'L' STA. 269+50.0
 (FOR DISPOSAL OF EXCESS MATERIAL)

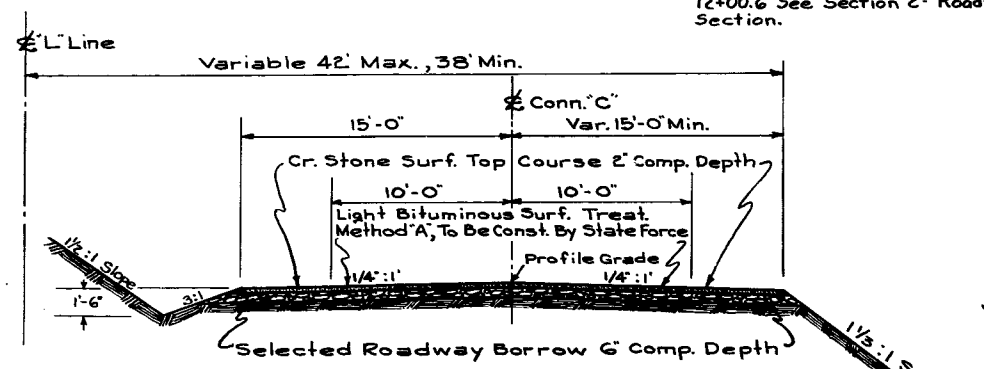

ROADWAY SECTION-C CONNECTION
 30' CRUSHED STONE SURFACING
 'C' STA. 0+00 To 'C' STA. 9+03.2

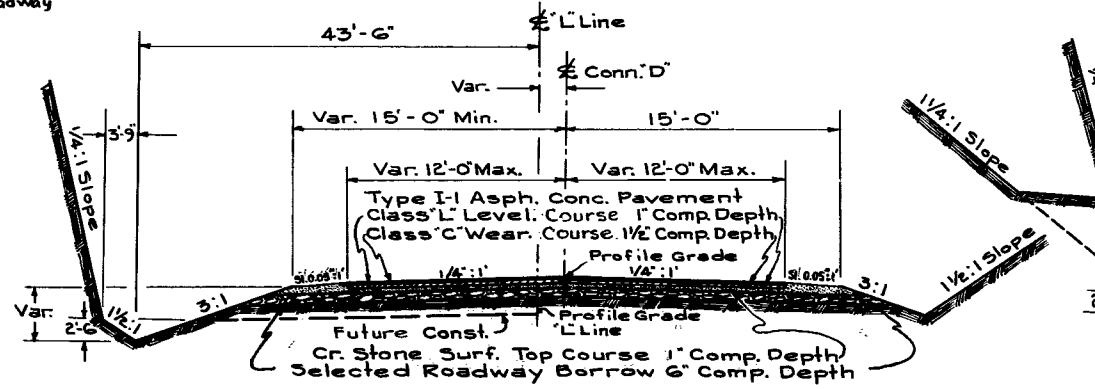

ROADWAY SECTION-D CONNECTION
 24' TYPE I-1 ASPH. CONC. PAVEMENT
 'D' STA. 0+00 To 'D' STA. 7+75.5

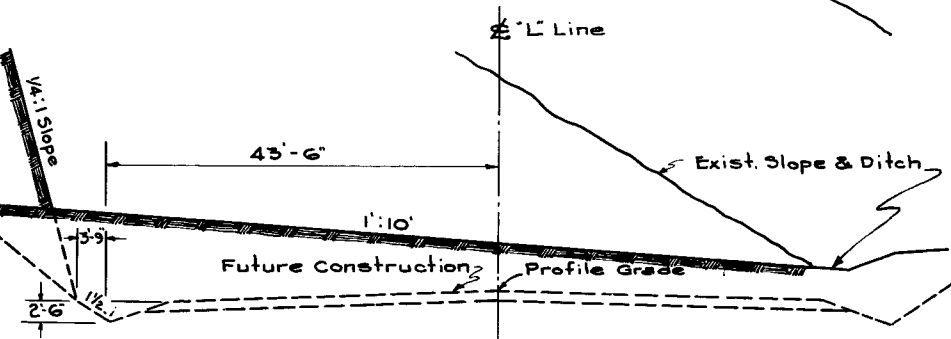

BORROW SECTION
 'L' STA. 273+93.85 To 'L' STA. 276+36.36

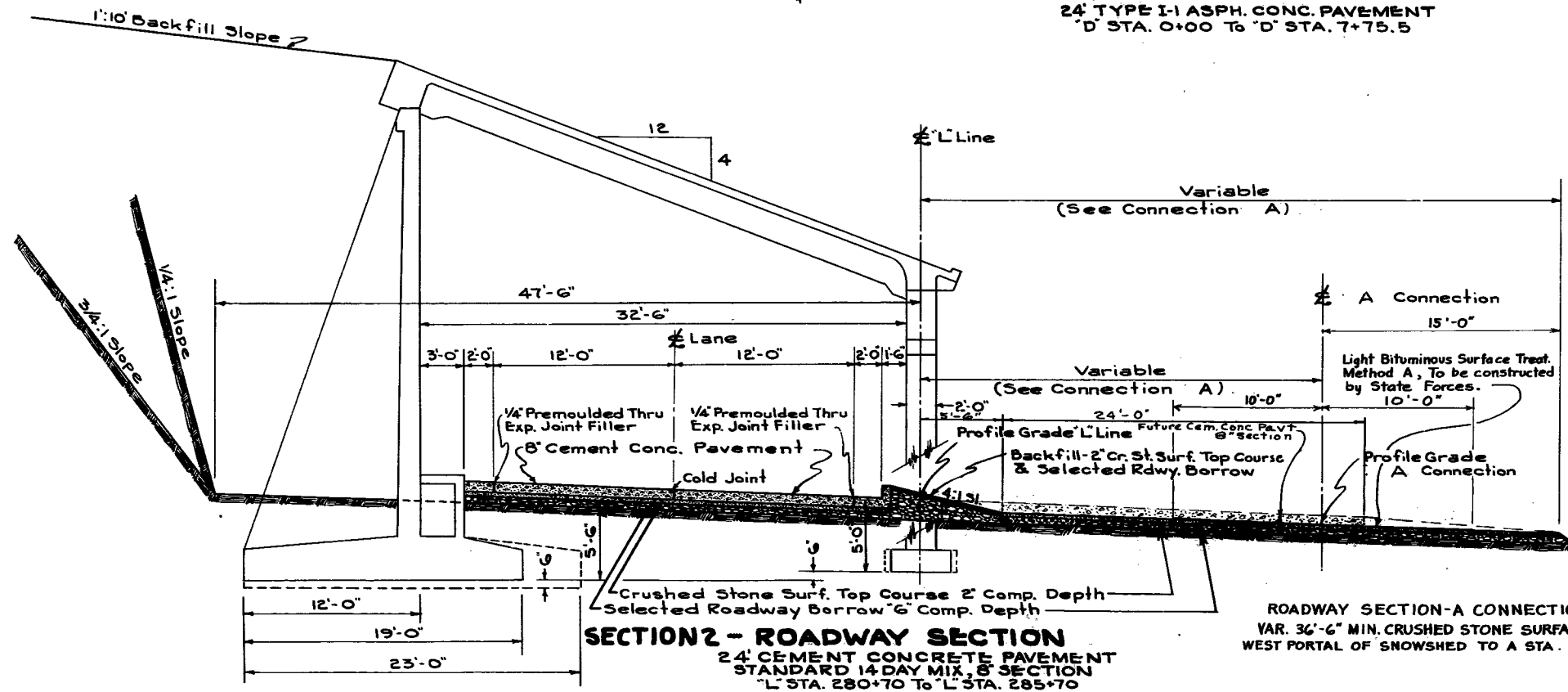

SECTION 2 - ROADWAY SECTION
 24' CEMENT CONCRETE PAVEMENT
 STANDARD 14 DAY MIX, 8" SECTION
 'L' STA. 280+70 To 'L' STA. 285+70

ROADWAY SECTION-A CONNECTION
 VAR. 36'-6" MIN. CRUSHED STONE SURFACING
 WEST PORTAL OF SNOWSHED TO A STA. 12+00.6

NOTE: TWO THIRDS NORMAL STANDARD SUPERELEVATION TO BE USED ON ALL ROADWAYS



SECTION 2 - LAKE KEECHELUS
 PRIMARY STATE HIGHWAY NO. 2
 AIRPLANE CURVE & LK. KEECHELUS SNOWSHEDS

KING & KITTITAS COUNTIES
 STATE OF WASHINGTON
 DEPARTMENT OF HIGHWAYS
 OLYMPIA, WASHINGTON
 APPROVED: JANUARY 30, 1950
 SHEET 5 OF 16 SHEETS
 CONTRACT NUMBER 3754

CHECKED
 1949
 MEMBER
 DIST. ENGINEER
 T. P. Doyle

S
 285

D3. Airplane Curve Snow Shed (Designed 1950, not built)

4 pages with plan, elevation, and cross-section drawings. Source: WSDOT engineering plans for Primary State Highway No. 2: Airplane Curve & Lk. Keechelus Snowsheds.

CHECKED
M.D. McMathan
LOC. ENGINEER
DIST. ENGINEER
T.R. Doyle

FED. ROAD DIV. NO.	STATE	FED. AID PROJ. NO.	FISCAL YEAR	SHEET NO.	TOTAL SHEETS
8	WASH.	FI-002-1(3)		4	11

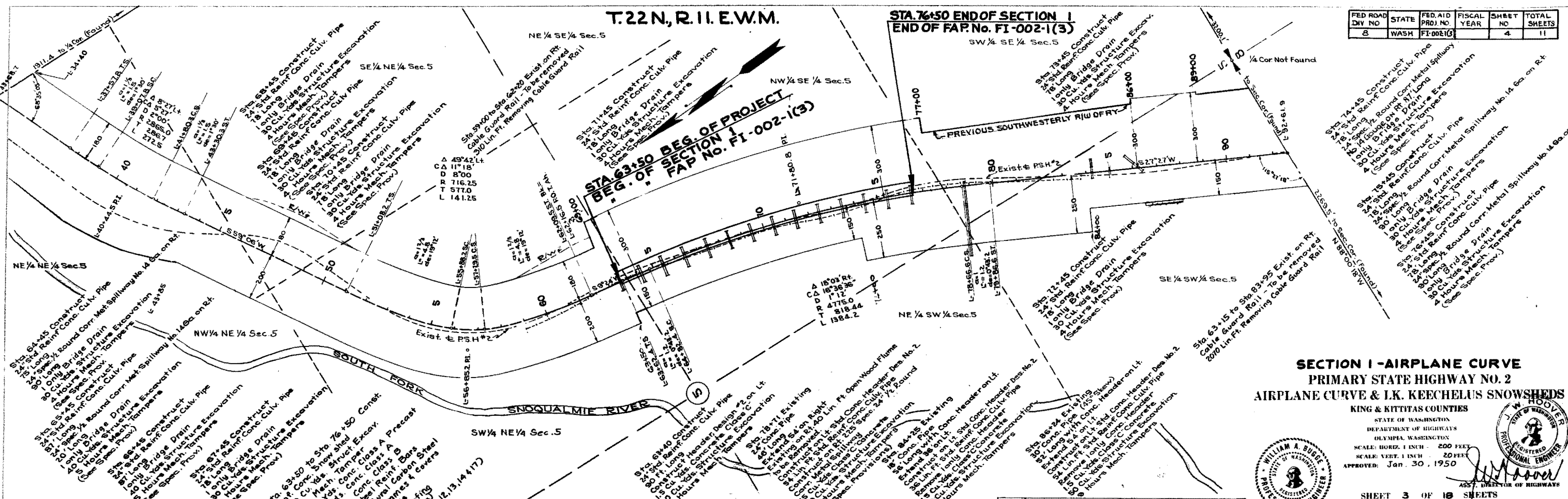

SECTION I - AIRPLANE CURVE
PRIMARY STATE HIGHWAY NO. 2
AIRPLANE CURVE & I.K. KEECHELUS SNOWSHEDS
 KING & KITTITAS COUNTIES
 STATE OF WASHINGTON
 DEPARTMENT OF HIGHWAYS
 OLYMPIA, WASHINGTON
 SCALE: HORIZ. 1 INCH = 200 FEET
 SCALE: VERT. 1 INCH = 20 FEET
 APPROVED: Jan. 30, 1950
 SHEET 3 OF 10 SHEETS
 CONTRACT NUMBER 3724

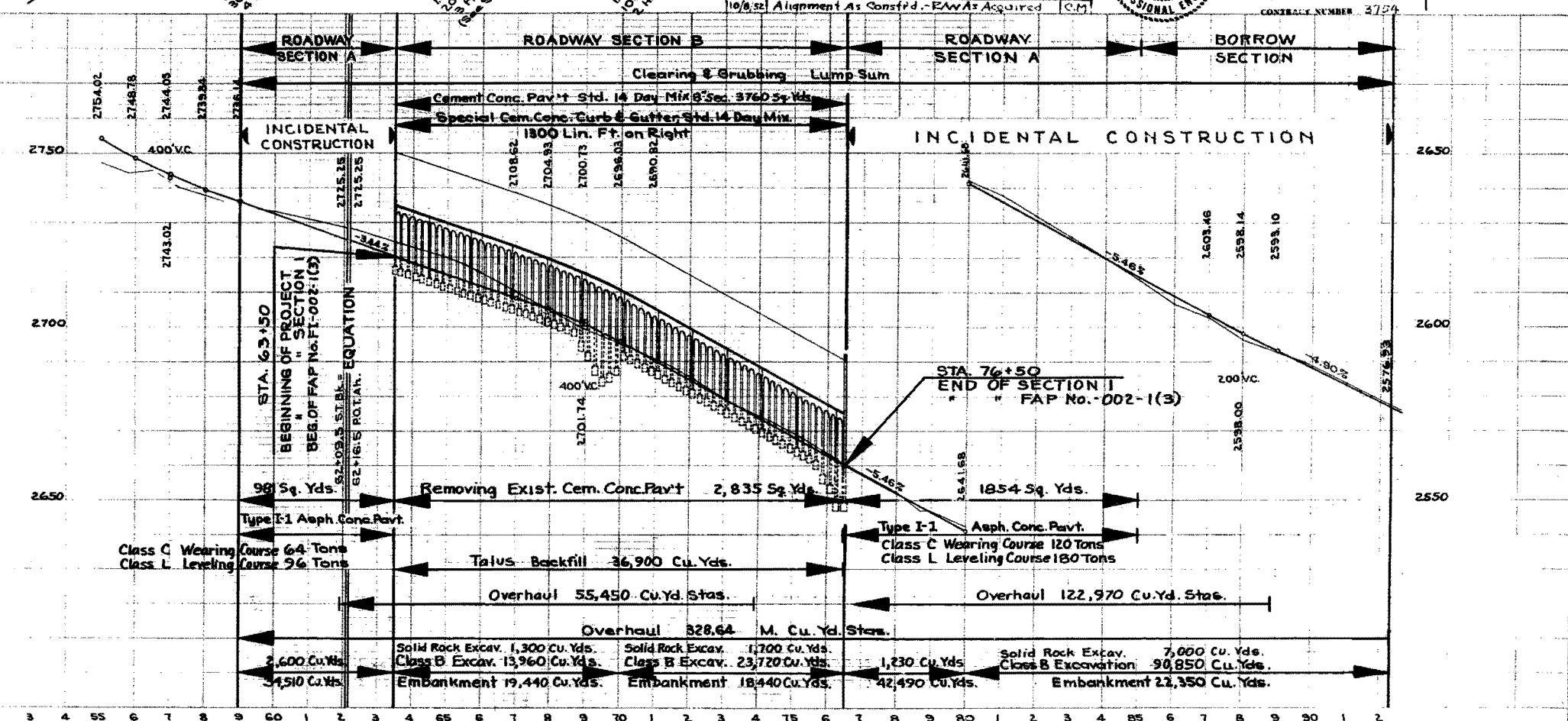

33 4 35 6 7 8 9 40 1 2 3 4 45 6 7 8 9 50 1 2 3 4 55 6 7 8 9 60 1 2 3 4 65 6 7 8 9 70 1 2 3 4 75 6 7 8 9 80 1 2 3 4 85 6 7 8 9 90 1 2

Clear Section (Vented)

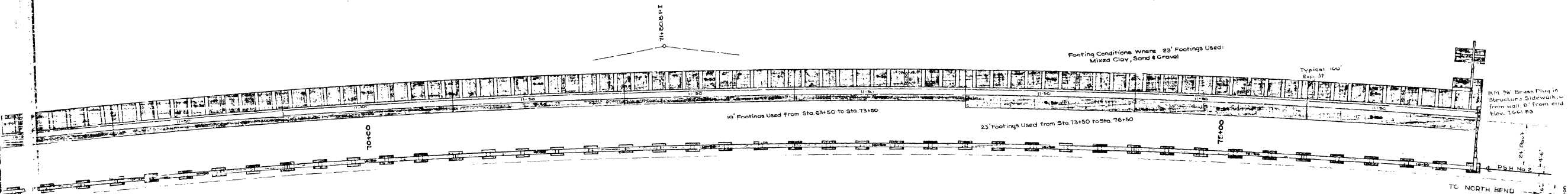

Δ 16' 03" Rt.
 CA 16' 36" 6"
 D 1" 17"
 R 47' 15" 0"
 T 1384.2
 T 812.44

PLAN
(Shown without Roof)

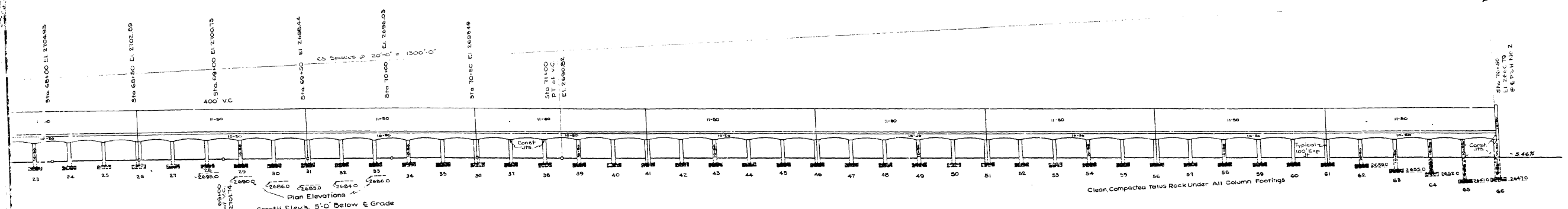

ELEVATION
(Developed along centerline)

SECTION 1 - AIRPLANE CURVE



Note:
Bottom of all column footings, unless shown otherwise are 5'-0" below ± grade

2 1/2" Brass Plug in Structure Sidewalk, 6" from wall, 6" from end. Elev. 2551.65

PSH No. 2

END

24" (Clear) Entrance Construction

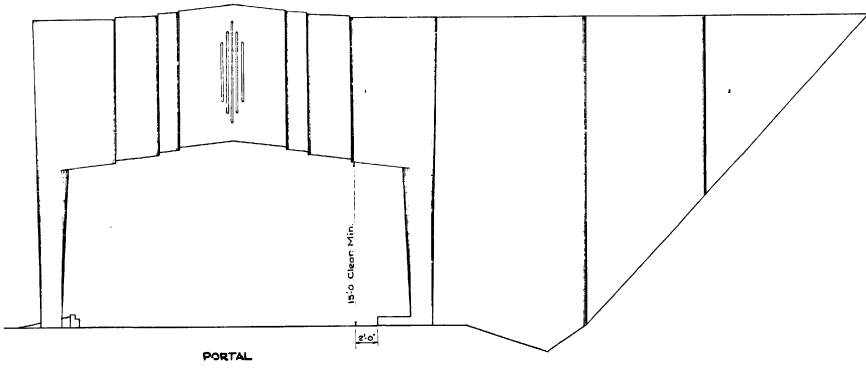
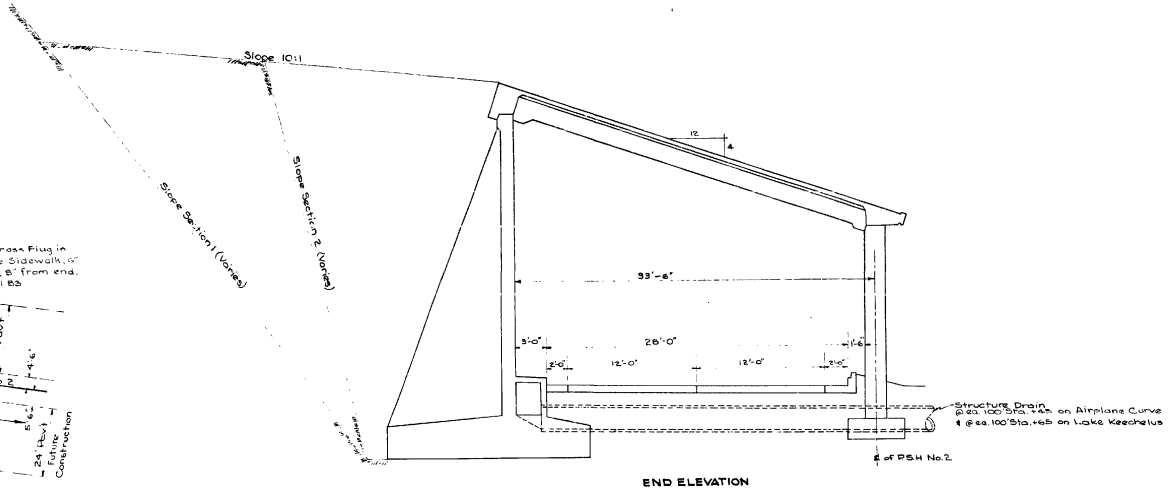

TYPICAL SECTIONS - AIRPLANE CURVE # LAKE KEECHELUS

North Portal Retaining Wall Revised in Accordance with Plan Revision Sheet No. 15-A of 18 Sheets, Dated August, 1950

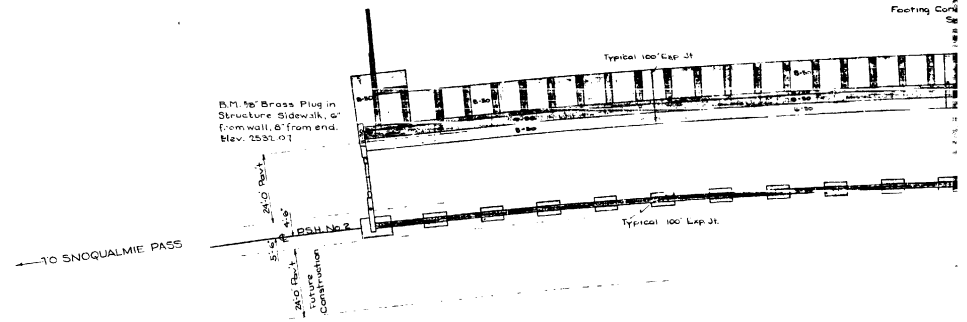

Note: Profile Grade Shown is Finished Grade 1/4 Standard Superelevation Used. Roadway Crowned 1/4 per foot in tangent Crown on Curves Estimated by Uniform Transition between S.T. & C.C.

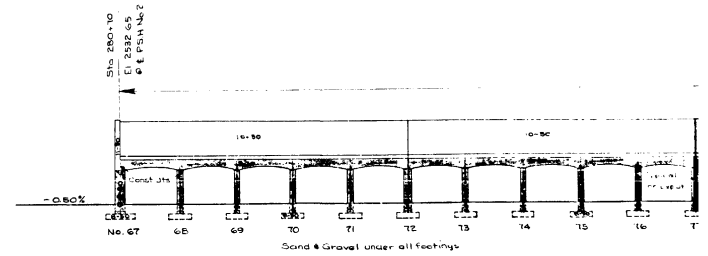

032 plus bid tab

SEC. 5, T. 22 N. R. 11 E. W.M.

DATE	BY	SCALE	PROJECT	NO.	TOTAL
0	WAB	1" = 30' 0"	10	0	11

Note: Profile grade shown is finished grade.
 The mass in elevation are developed along centerline.
 Use standard super-elevation.
 Roadway crowned 1/2" per foot on tangent. Crown eliminated at curve by a uniform transition between T.S. and S.C.



1	2	3	4	5	6	7	8	9	10	11	12	13	14	15	16	17	18	19	20	21	22	23	24	25	26	27	28	29	30	31	32	33	34	35	36	37	38	39	40	41
---	---	---	---	---	---	---	---	---	----	----	----	----	----	----	----	----	----	----	----	----	----	----	----	----	----	----	----	----	----	----	----	----	----	----	----	----	----	----	----	----

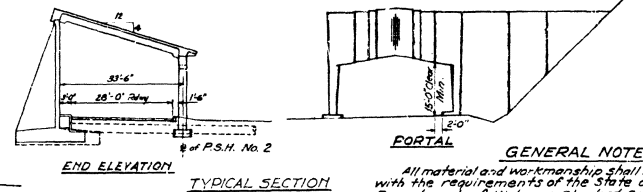
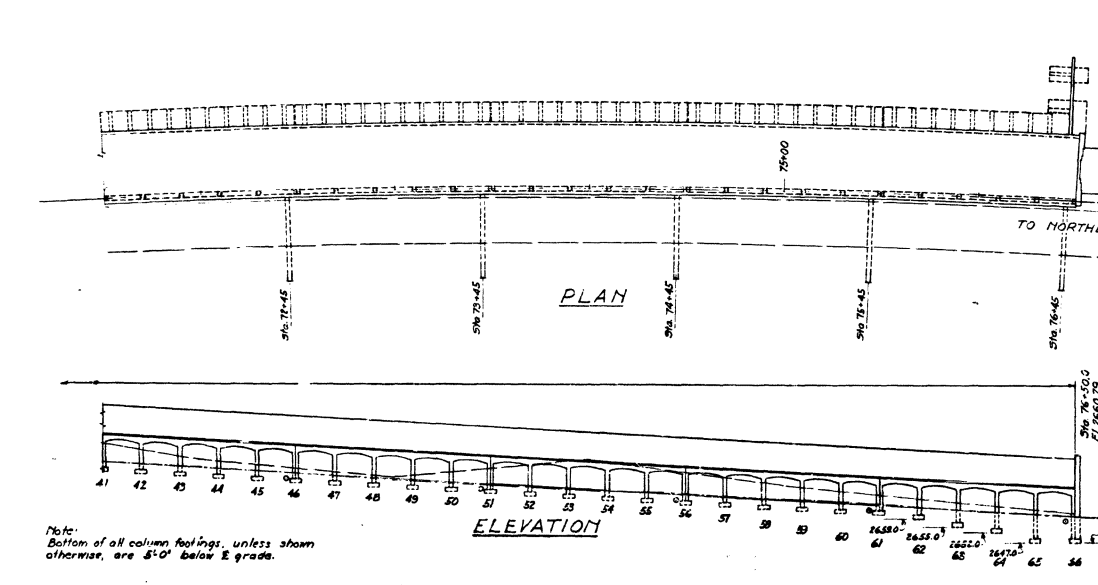
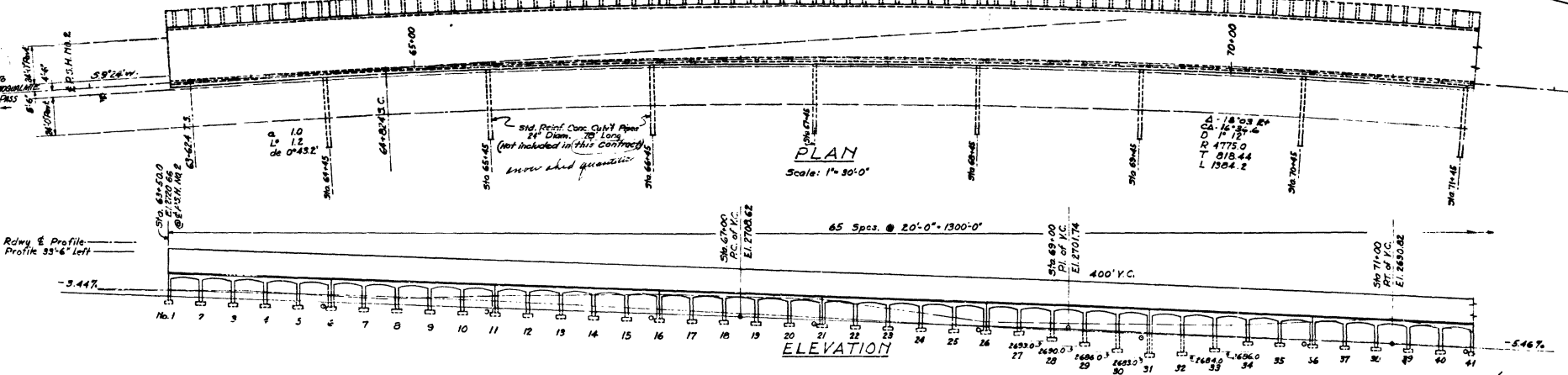

APPROXIMATE QUANTITIES

ITEM	UNIT	AIRPLANE CURVE	L.K. KEPCHELUS
Structure Excavation	Cu Yds	7450	3330
Mechanical Trench	Days	40	16
Concrete Class "A" Precast	Cu Yds	2250	270
Concrete Class "A"	Cu Yds	450	22.5
Concrete Class "B"	Cu Yds	6900	2900
Steel Reinforcing Bars	Lbs	193,000	775,000
Structural Carbon Steel	Lbs	1500	700
Manhole Frames & Covers	Only	13	5
Copper Seals	Lbs	240	104
Waterproofing	Sq Yds	1110	430
Removal Structure	None	-	Lump Sum

GENERAL NOTES
 All material and workmanship shall be in accordance with the requirements of the State of Washington, Department of Highway Standard Specifications for Road and Bridge Construction dated April, 1968.
 Footing elevations are subject to change depending on foundation material encountered and reinforcing steel shall not be cut until final footing elevations have been determined in the field.
 All concrete in footings, walls and counter-ports shall be class "B" mix. All other concrete shall be Class "A" mix. Roof units shall be precast.

PRIMARY STATE HIGHWAY NO. 2
 AIRPLANE CURVE & L.K. KEPCHELUS'S SNOWSHEDS
 KING & KITITAS COUNTIES

LAYOUT - AIRPLANE CURVE

Note: Bottom of all column footings, unless shown otherwise, are 3'-0" below E grade.



STATE OF WASHINGTON
 DEPARTMENT OF HIGHWAYS
 GENERAL ENGINEER
 APPLICANT: L.K. KEPCHELUS
 SHEET 9 OF 10 SHEETS
 CONTRACT NUMBER 20-0-1

D3. Keechelus Lake Snowshed (1931, 1933)

2 pages with drawings for the original design and extensions on the wooden structures built along Lake Keechelus in 1931 and 1933.

FED. ROAD DIST. NO.	STATE	N.R. PROJ. NO.	FISCAL YEAR	SHEET NO.	TOTAL SHEETS
1	WASH.	N.R. 43	1934	5	5

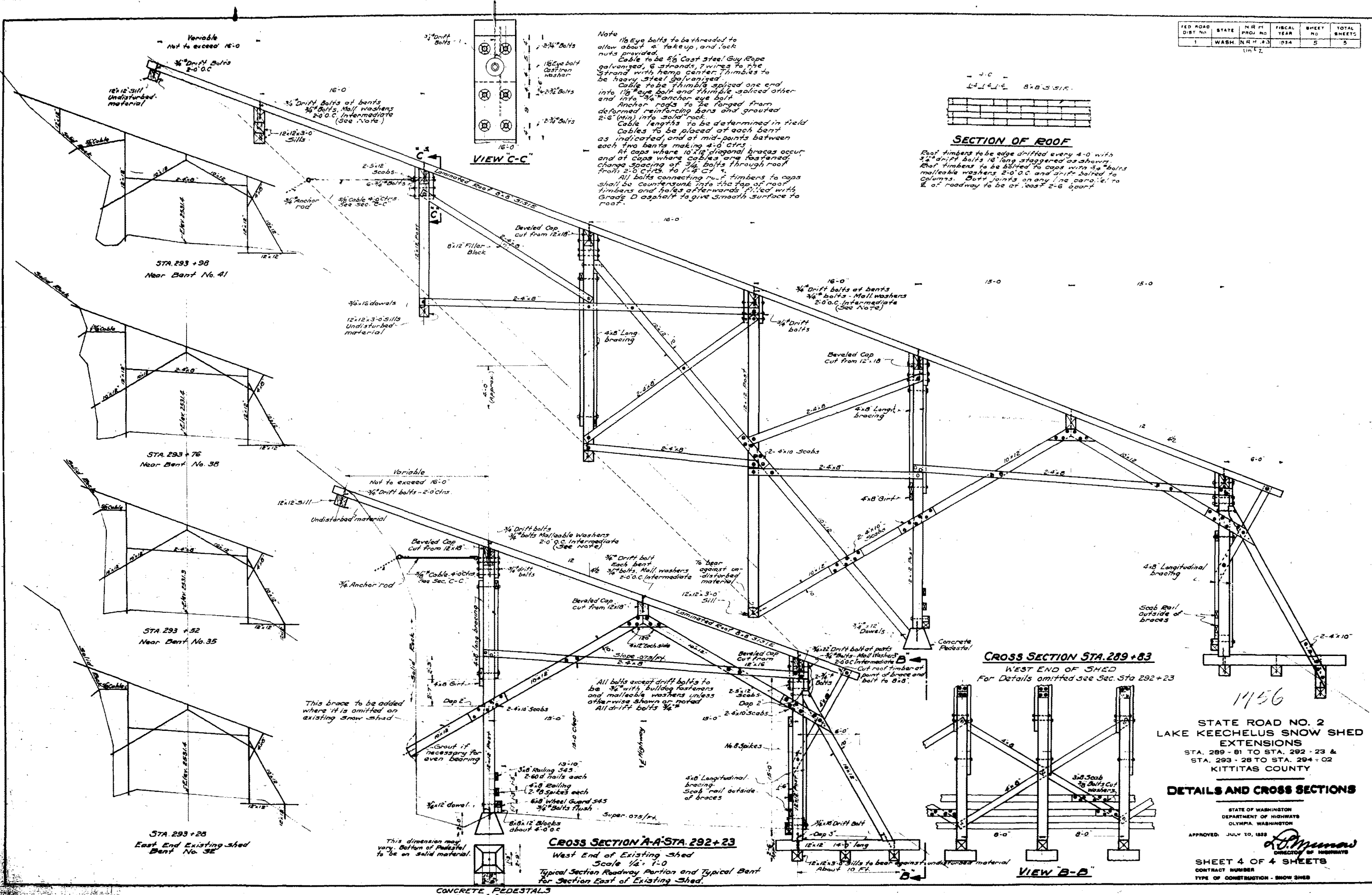

Note
 1/2" Eye bolts to be threaded to allow about 4" take up, and lock nuts provided.
 Cable to be 5/8" Cast Steel Guy Rope galvanized, 6 strands, 7 wires to the strand with hemp center. Thimbles to be heavy steel galvanized.
 Cable to be thimble spliced one end into 1/2" eye bolt and thimble spliced other end into 3/4" anchor eye bolt.
 Anchor rods to be forged from deformed reinforcing bars and grouted 2-6" (Min) into solid rock.
 Cable lengths to be determined in field.
 Cables to be placed at each bent as indicated, and at mid-points between each two bents making 4-0' Ctrs.
 At caps where 10x12 diagonal braces occur, and at caps where cables are fastened, change spacing of 3/4" bolts through roof from 2-0' Ctrs. to 1-4' Ctr.
 All bolts connecting roof timbers to caps shall be countersunk into the top of roof timbers and holes afterwards filled with Grade D asphalt to give smooth surface to roof.

SECTION OF ROOF

Roof timbers to be edge drilled every 4-0 with 3/4" drift bolts 18" long staggered as shown. Roof timbers to be bolted to caps with 3/4" bolts malleable washers 2-0" O.C. and drift bolted to columns. Bolt joints on any line parallel to E. of roadway to be at least 2-6' apart.

CROSS SECTION STA. 289+83

WEST END OF SHED
 For Details omitted see Sec. Sta 292+23

CROSS SECTION A-A STA. 292+23

West End of Existing Shed
 Scale 1/2" = 1'-0"
 Typical Section Roadway Portion and Typical Bent for Section East of Existing Shed.

1156
 STATE ROAD NO. 2
 LAKE KEECHELUS SNOW SHED
 EXTENSIONS
 STA. 289 - 81 TO STA. 292 - 23 &
 STA. 293 - 28 TO STA. 294 + 02
 KITTITAS COUNTY

DETAILS AND CROSS SECTIONS

STATE OF WASHINGTON
 DEPARTMENT OF HIGHWAYS
 OLYMPIA, WASHINGTON
 APPROVED: JULY 20, 1933
 [Signature]
 DIRECTOR OF HIGHWAYS
 SHEET 4 OF 4 SHEETS
 CONTRACT NUMBER
 TYPE OF CONSTRUCTION - SNOW SHED

CONCRETE PEDESTALS
 CLASS C CONCRETE

Appendix E – Wyoming DOT

This appendix contains the details on the proposed snowshed (1992) on State Highway 22 at Teton Pass.

E1. Proposed Glory Bowl Snow Shed (Proposed 1992, not built)

1 page with plan, elevation, and cross-section drawings. Source: WYDOT Plan and Profile of Proposed State Highway: Jackson-Idaho State Line.

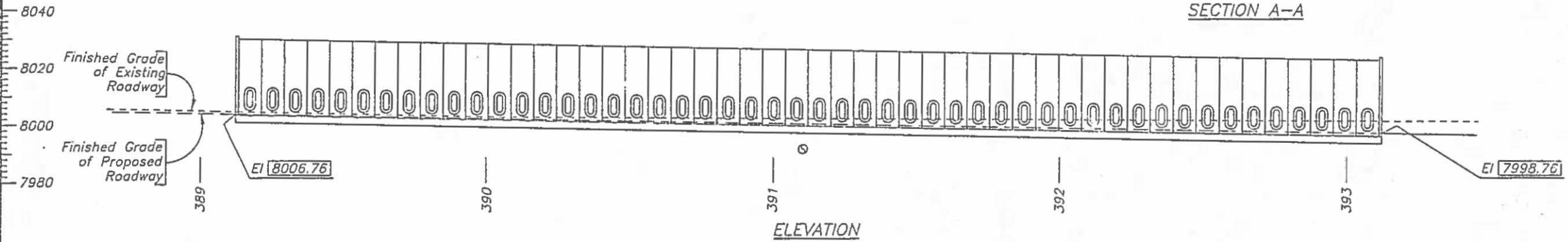
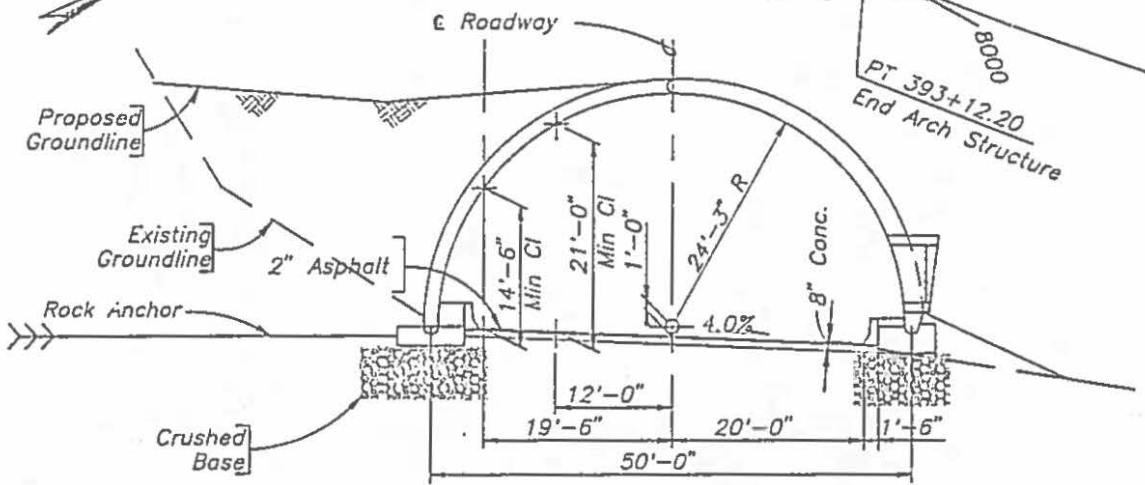
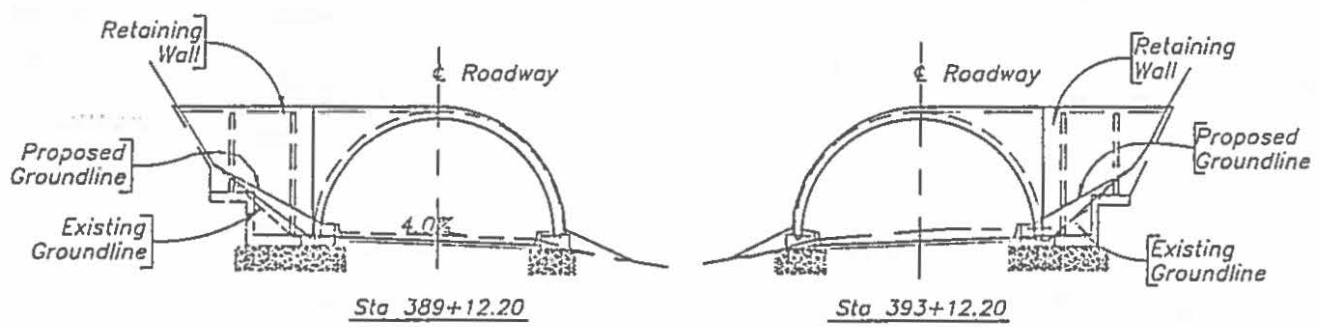
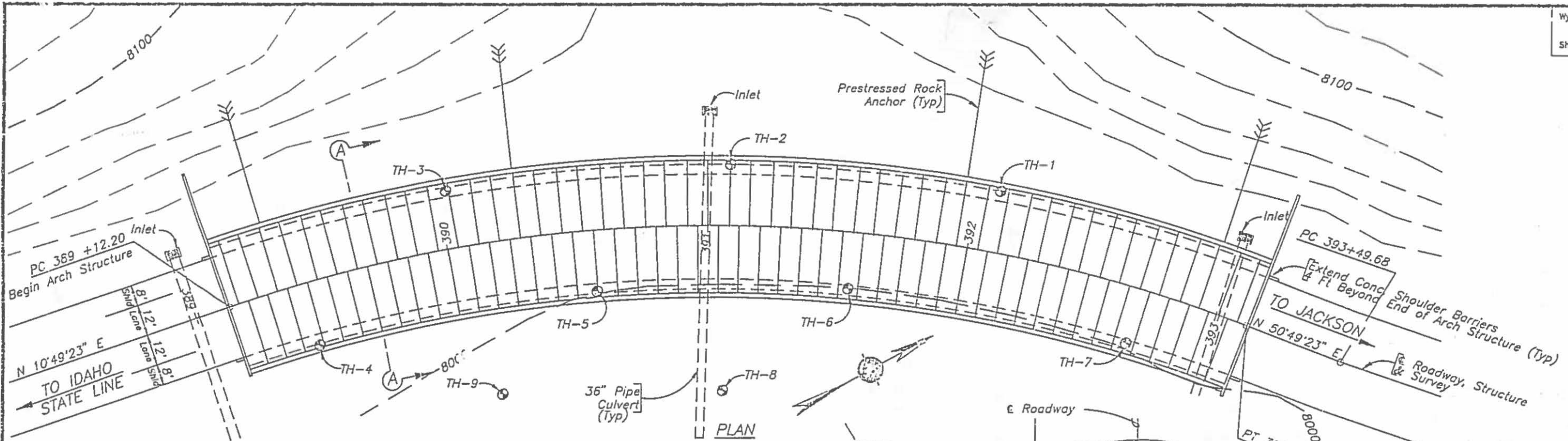

Note: Elevations indicate Grade at and End of on ϵ of R

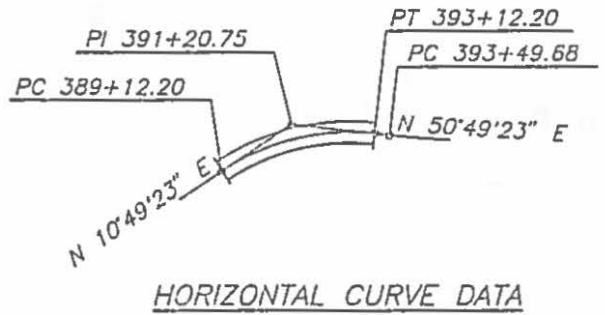
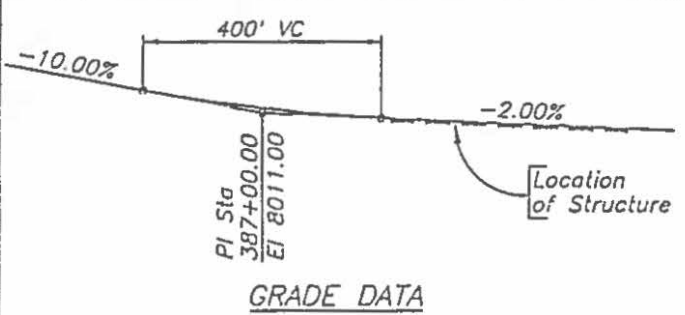

CURVE DATA
 $\Delta = 40^{\circ}00'$ Rt
 $D = 10^{\circ}00'$
 $T = 208.55$
 $L = 400.00'$
 $E = 36.77'$
 $R = 573'$
 $e = .040 \%$

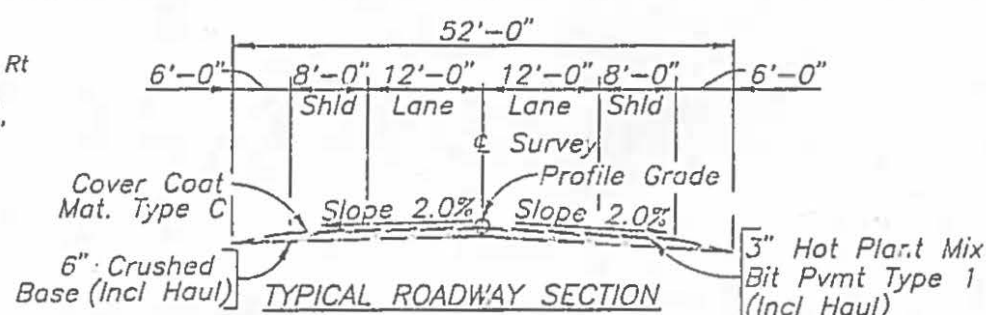

WYOMING DEPARTMENT OF TRANSPORTATION BRIDGE DIVISION	
GENERAL PLAN AND SNOWSHED AT GI STA 391+1 Jackson-Idaho Stat 2000(26)	
REVISIONS	DESIGN H.M.M. / DETAIL G.D.W. / DATE
APPROVED	Design Smitian Meh Draw No 6113

Appendix F – Parks Canada, Glacier National Park

This appendix contains the details on three snow sheds in Glacier National Park

F1. Pioneer (built 1961)

3 pages with site plan (2 versions), elevation, and cross-section drawings. Source: COWI.

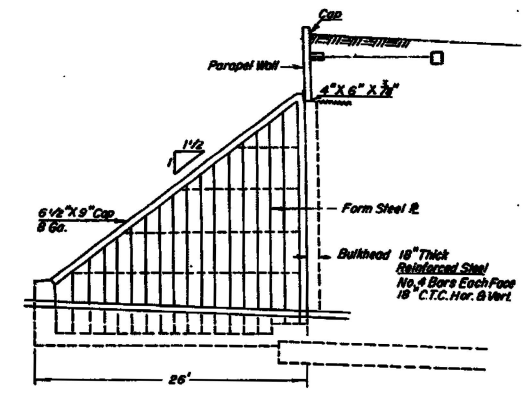
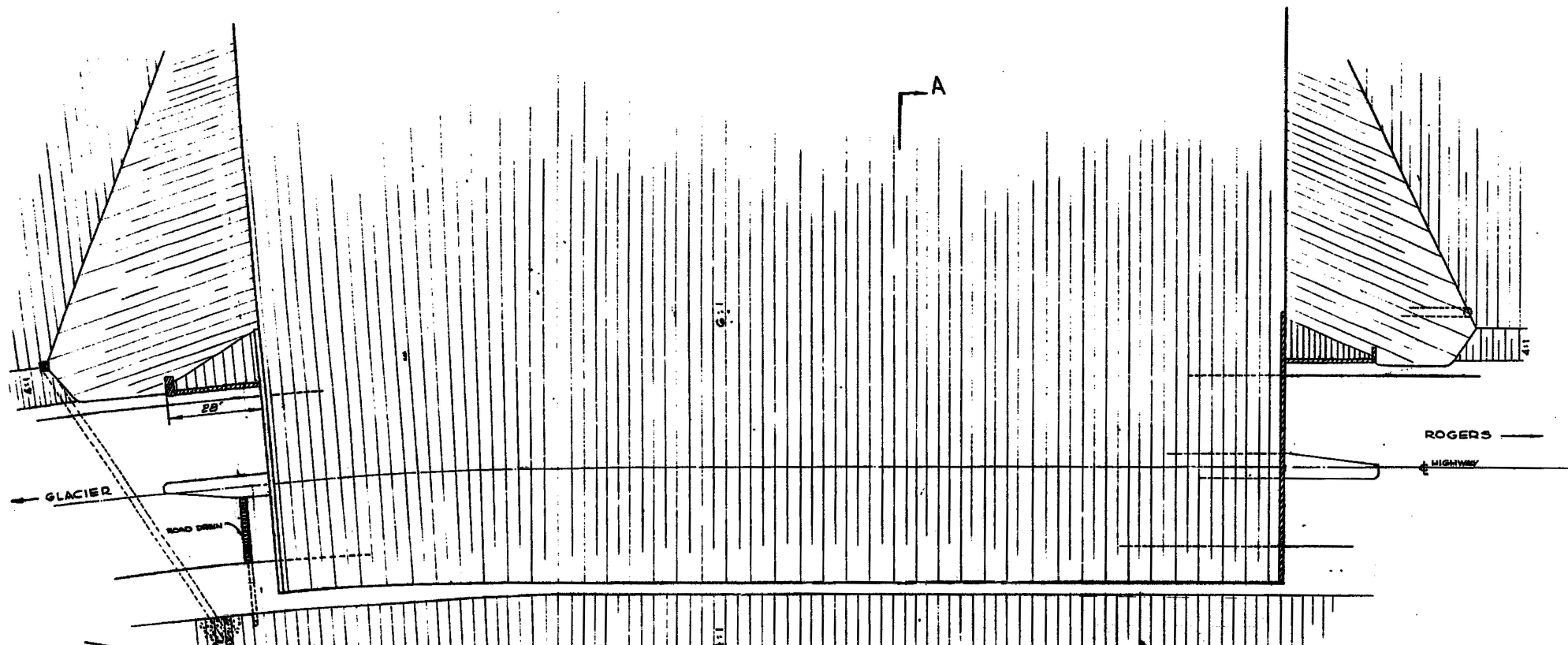

PROFILE AT WING WALLS
SCALE 1/4" = 1'

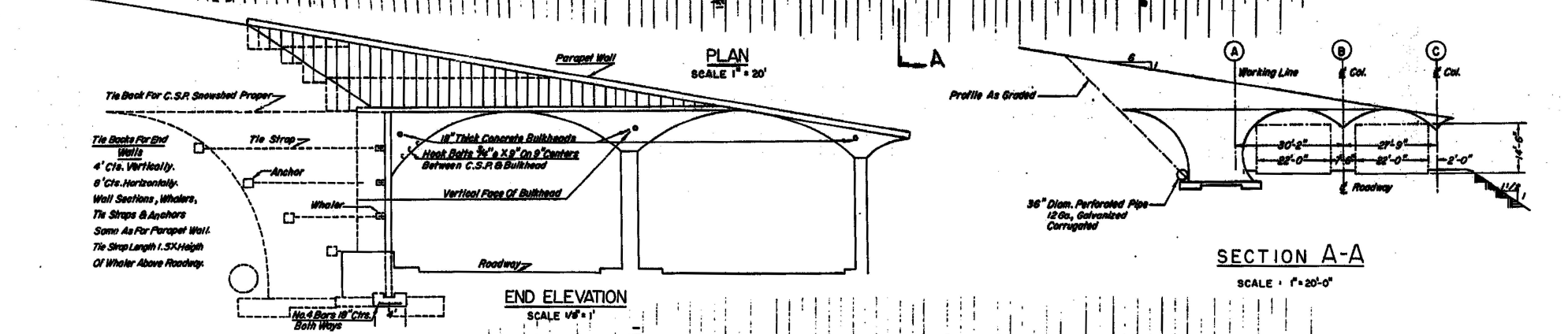

SECTION A-A
SCALE 1" = 20'-0"

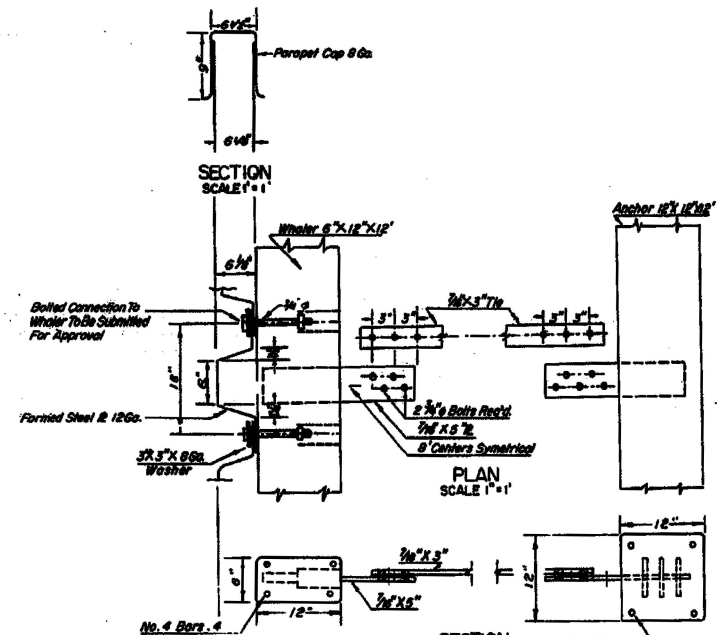

PARAPET WALL & ANCHOR DETAILS
SCALE 1" = 1'

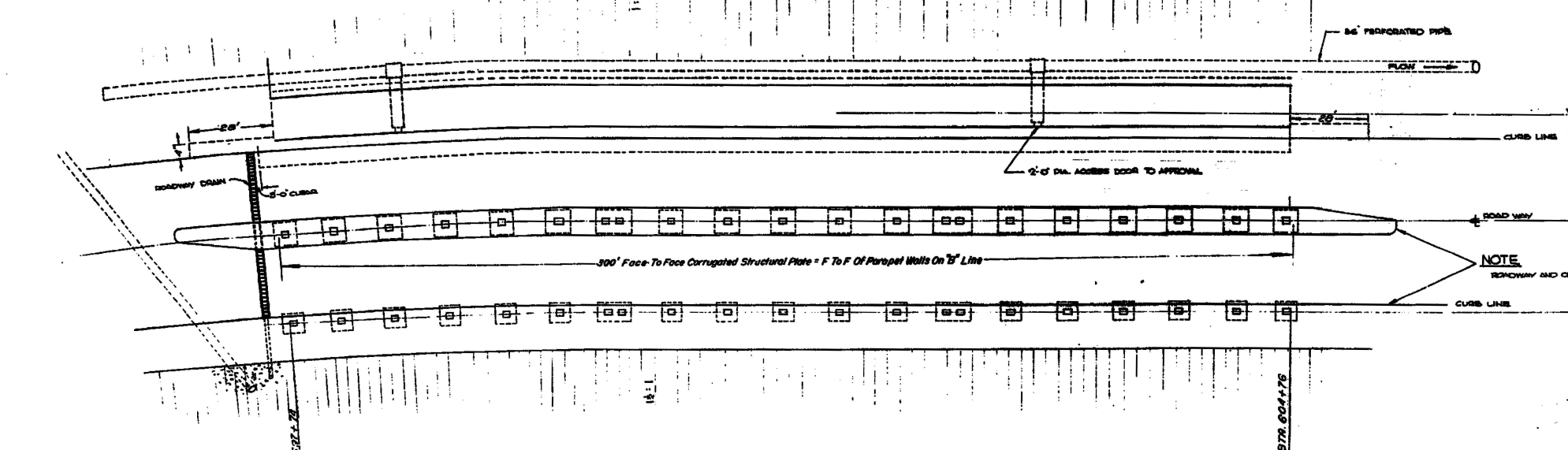

FOUNDATION PLAN
SCALE 1" = 20'-0"

DEPARTMENT OF PUBLIC WORKS
CANADA
DEVELOPMENT ENGINEERING BRANCH
STRUCTURES DIVISION
NO. 1 SNOWSHED
T.C.H. MILE 11.01
GLACIER NATIONAL PARK

CORRUGATED STRUCTURAL PLATE ALTERNATIVE
GENERAL LAYOUT

JOB SUPERVISOR S. STAMER	DESIGN	CHECK
APPROVED DATE 26/9/60	DRAWN	CHECK
<i>[Signature]</i>	TRACED	CHECK
CHIEF STRUCTURES DIVISION	PROJECT NO.	

APPROVED DATE 27/10/60	DESIGNED BY <i>[Signature]</i>
<i>[Signature]</i> CHIEF ENGINEER	DATE

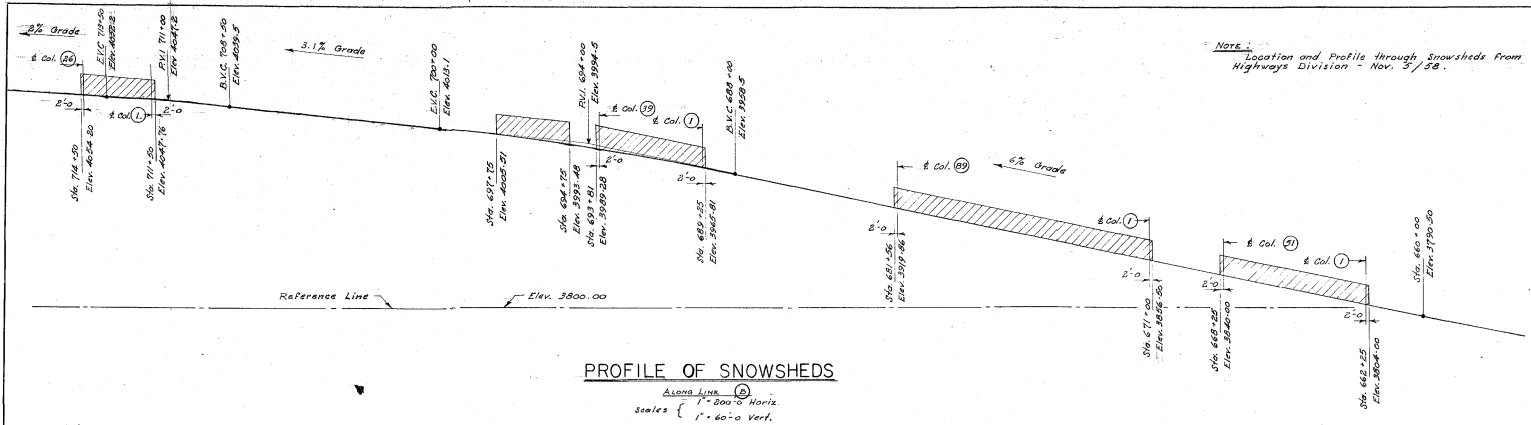
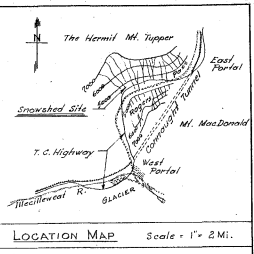

PROFILE OF SNOWSHEDS
 As shown on (1)
 scales 1" = 200' Horiz.
 1" = 60' Vert.

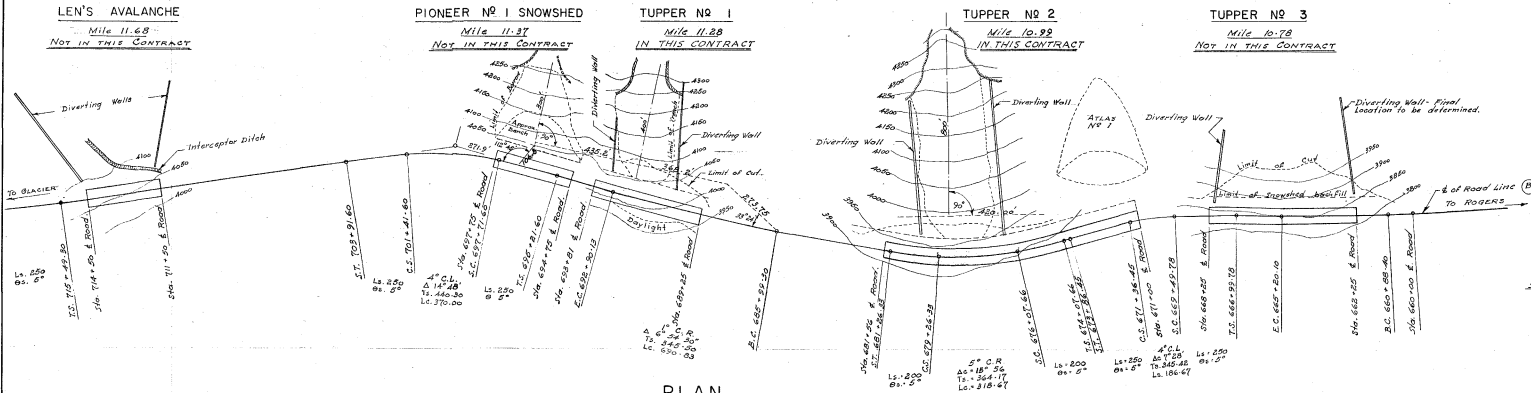

PLAN
 Scale 1" = 200'-0"

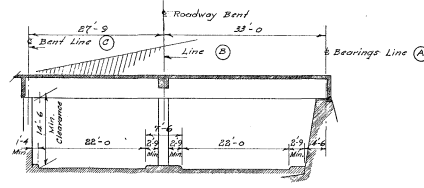

TYPICAL SECTION
 Showing Clearances
 Scale 1" = 10'-0"

NOTE: Location and Profiles through Snowsheds From Highways Division - Nov. 3/58.

NOTE: Tupper No 1 and No 2, in this Contract Only.

No.	REVISIONS	NAME	DATE
DEPARTMENT OF PUBLIC WORKS CANADA DEVELOPMENT ENGINEERING BRANCH STRUCTURES DIVISION TUPPER #1 & 2 SNOWSHEDS MI. 11.28 B 10.99 GLACIER NATIONAL PARK SITE PLAN			
JOB SUPERVISOR	S. Stamer	DESIGN	CHECK
APPROVED	DATE 2/10/64	DRAWN	L.B.P. CHECK T.D.
		TRACED	CHECK
CHIEF ENGINEER	DATE 2-10-64	PROJECT NO.	SD-106 B 107
		SHEET	2 of 24



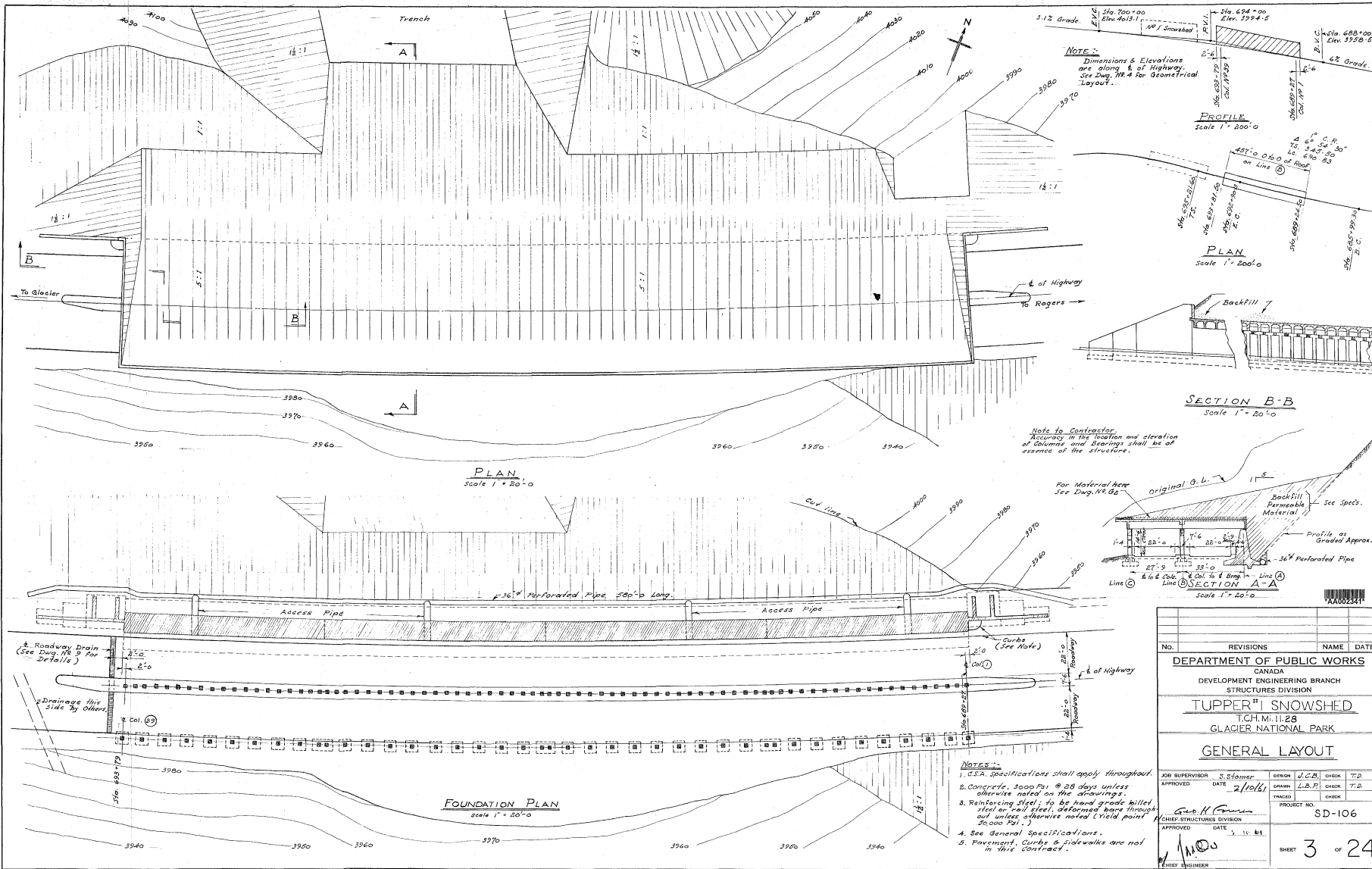

F2. Tupper #1 (built 1962) and later joined to 1962 re-build of Pioneer

2 pages with site plan, elevation, and cross-section drawings. Source: COWI.

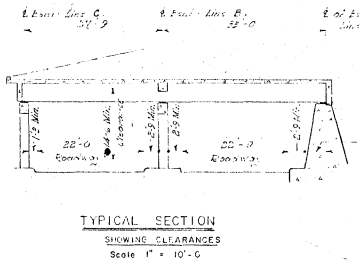
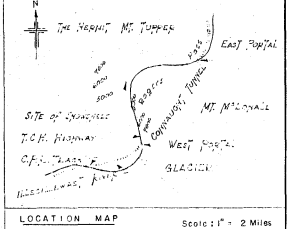
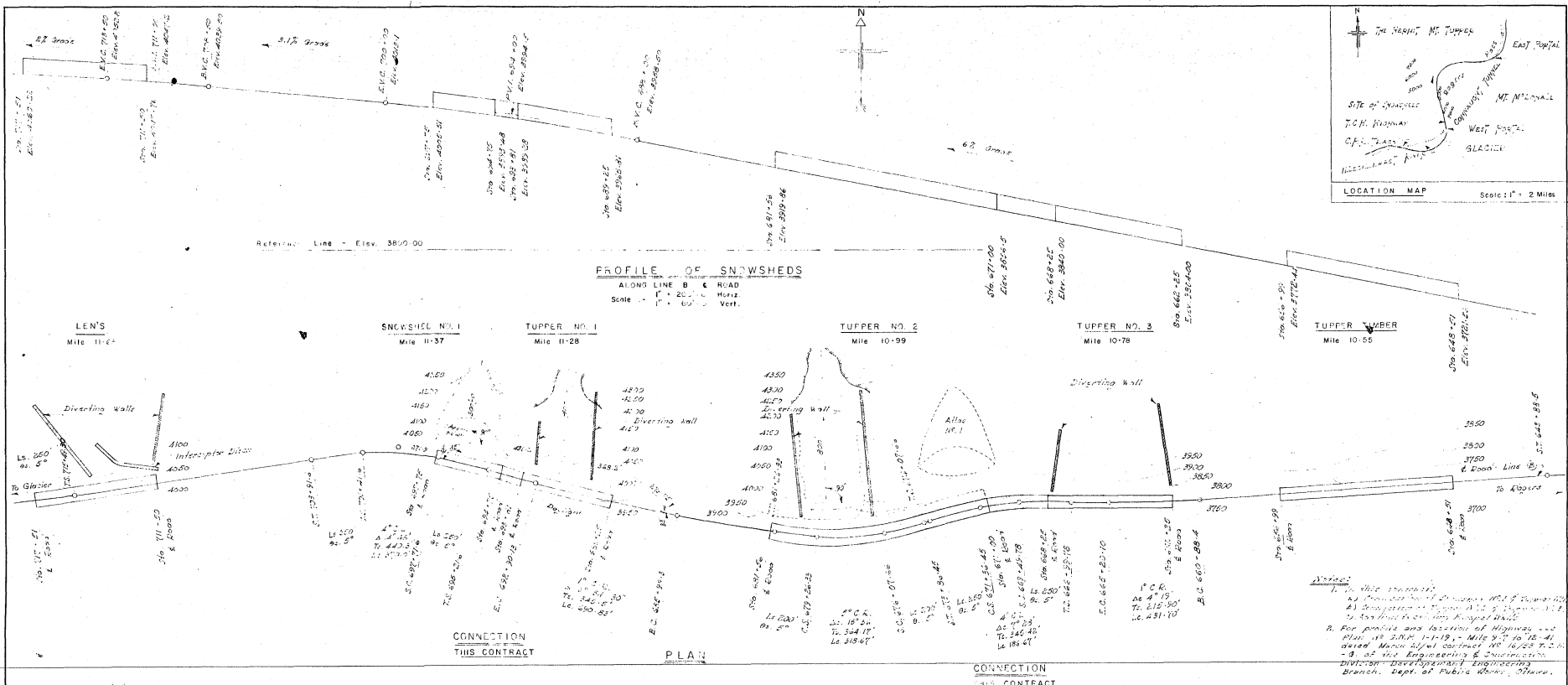

- CONNECTION THIS CONTRACT
- CONNECTION -10- CONTRACT
- PLAN
- LIST OF DRAWINGS
- 1. PERSPECTIVE VIEW
 - 2. SITE PLAN
 - 3. GENERAL LAYOUT
 - 4. LAYOUT DATA
 - 5. RETAINING WALL - CONCRETE DETAILS
 - 6. RETAINING WALL - STEEL REINFORCING
 - 7. E.O.F. ROADWAY BENT - Line (C) = CONC. & REINF. DETAILS
 - 8. DOWNHILL BENT - Line (C) = CONCRETE DETAILS
 - 9. DOWNHILL BENT - Line (C) = DETAILS OF REINFORCING
 - 10. ROOF SLAB - CONCRETE & REINFORCING DETAILS
 - 11. ROOF SLAB - TYPICAL SECTIONS & DETAILS
 - 12. ROOF BEAMS
 - 13. BEARING DETAILS - ROOF BEAMS
 - 14. ROADWAY EXCAVATION, BACKFILL & MISCELLANEOUS DETAILS
 - 15. GENERAL LAYOUT
 - 16. RETAINING WALL - CONC. & REINF. DETAILS
 - 17. E.O. ROADWAY BENT - Line (C) = CONC. & REINF. DETAILS
 - 18. DOWNHILL BENT - Line (C) = CONC. & REINF. DETAILS
 - 19. ROOF SLAB - CONC. & REINF. DETAILS
 - 20. ROOF DETAILS - AT JUNCTION OF EXISTING SNOWSHED NO. 1
 - 21. ROOF BEAMS
 - 22. BEARING DETAILS - ROOF BEAMS
 - 23. ROADWAY EXCAVATION BACKFILL & MISCELLANEOUS DETAILS
 - 24. MANHOLE - CONC. & REINF. DETAILS
 - 25. ADDITION TO EXISTING PARAPETS - ASSEMBLY DETAILS
 - 26. ADDITION TO EXISTING PARAPETS - PRECAST UNITS
 - 27. SCHEDULE TUPPER NO. 2 & TUPPER NO. 3
 - 28. SCHEDULE TUPPER NO. 1 & SNOWSHED NO. 1 ADDITION TO EXISTING PARAPETS

NO.	REVISIONS	NAME	DATE
DEPARTMENT OF PUBLIC WORKS			
CANADA			
DEVELOPMENT ENGINEERING BRANCH			
STRUCTURES DIVISION			
CONNECTIONS			
SNOWSHED NO. 1 & TUPPER NO. 1 Mile 11-37			
TUPPER NO. 2 & TUPPER NO. 3 Mile 10-99			
- GLACIER NATIONAL PARK -			
SITE PLAN			
JOB SUPERVISOR	S. Stamer	DRAWN	L.B.P.
APPROVED	DATE 11/2/66	CHECK	T.D.
C. H. Stevens		TRACED	CHECK
CHIEF STRUCTURES DIVISION		PROJECT NO.	SD - 169
APPROVED DATE 11/3/66		SHEET 2 OF 28	
C. T. Clarke		CHIEF ENGINEER	

AA002211

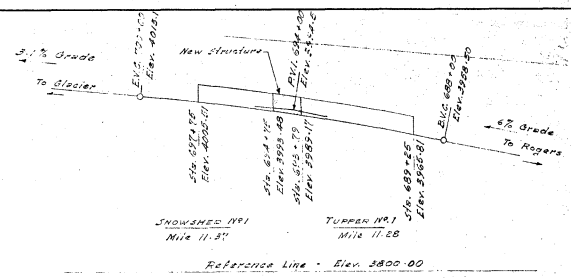

PROFILE OF SNOWSHEDS
ALONG LINE B & ROAD
Scale 1" = 20'0" Horiz.
Scale 1" = 60'0" Vert.

LAYOUT DATA									
ALONG LINE (A)	OF ROAD	ALONG LINE (B)	ALONG LINE (C)	ALONG LINE (A)	ALONG LINE (A)	ALONG LINE (A)	ALONG LINE (A)	ALONG LINE (A)	ALONG LINE (A)
COLUMN NO.	STATION	ELEVATION	CENTRE TO CENTRE OF COLUMN	CENTRE TO CENTRE OF COLUMN	ELEVATION	ETS TO CRT OF COLUMN	ELEVATION	ETS TO CRT OF COLUMN	DIMENSION OF BEAMS
39	43+79.0	92.50	2'-0"	2'-0"	92.50	8'-0"	92.50	8'-0"	1'-4"
40	44+00.0	92.50	2'-0"	2'-0"	92.50	8'-0"	92.50	8'-0"	1'-4"
41	44+21.0	92.50	2'-0"	2'-0"	92.50	8'-0"	92.50	8'-0"	1'-4"
42	44+42.0	92.50	2'-0"	2'-0"	92.50	8'-0"	92.50	8'-0"	1'-4"
43	44+63.0	92.50	2'-0"	2'-0"	92.50	8'-0"	92.50	8'-0"	1'-4"
44	44+84.0	92.50	2'-0"	2'-0"	92.50	8'-0"	92.50	8'-0"	1'-4"
45	45+05.0	92.50	2'-0"	2'-0"	92.50	8'-0"	92.50	8'-0"	1'-4"
46	45+26.0	92.50	2'-0"	2'-0"	92.50	8'-0"	92.50	8'-0"	1'-4"
47	45+47.0	92.50	2'-0"	2'-0"	92.50	8'-0"	92.50	8'-0"	1'-4"

- ROOF BEAM SPACING
1. A roof beam is located over each column on line (A) and (C) and is located at the wall on line (B) or exterior of the line joining the columns.
 2. The intermediate roof beams are located equidistant between the column spacings on line (A) and line (C) and over columns with odd "m" on line (B).
 3. Columns designated "m" are located on line (B) only.

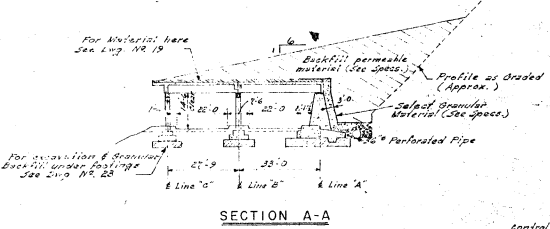

SECTION A-A
Scale 1" = 20'-0"

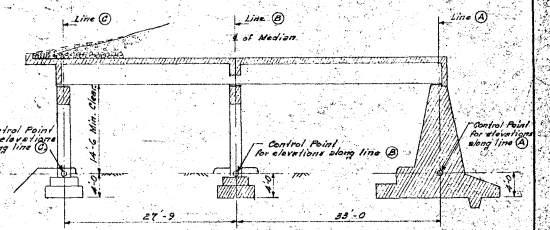

TYPICAL CROSS SECTION
Scale 1/2" = 1'-0"

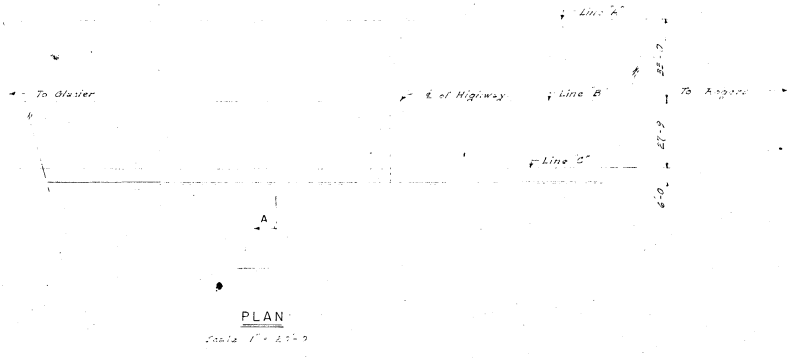

PLAN
Scale 1" = 20'-0"

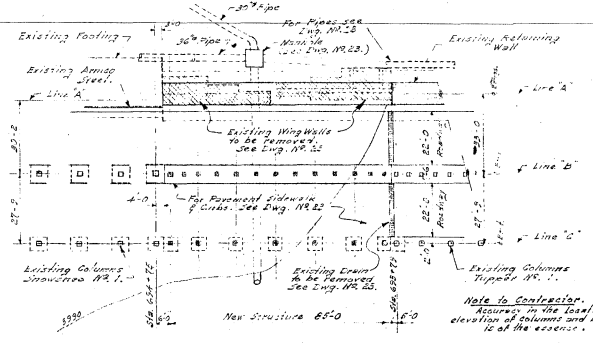

FOUNDATION PLAN
Scale 1" = 20'-0"

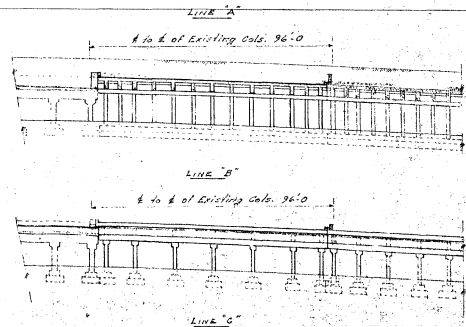

ELEVATIONS
Scale 1" = 20'-0"

NO.	REVISION	NAME	DATE

DEPARTMENT OF PUBLIC WORKS
DEVELOPMENT ENGINEERING BRANCH
STRUCTURES DIVISION

CONNECTION
TUPPER NR.1 & SNOWSHED NR.1
MILE 11-28
GLACIER NATIONAL PARK

GENERAL LAYOUT

JOB SUPERVISOR	BY	DATE
S. Stamer	T.B.	

APPROVED DATE: 11/3/66

CHIEF STRUCTURES DIVISION

APPROVED DATE: 11/3/66

PROJECT NO. SD-169

CHIEF ENGINEER: J.T. Clark

SHEET 15 OF 28

F3. Single Bench (built 1978)

5 pages with site plan, elevation, cross-section drawings, wing wall details and interior elevations. Source: COWI.

inches 0 1 2 3 4 5 6 7 8 9

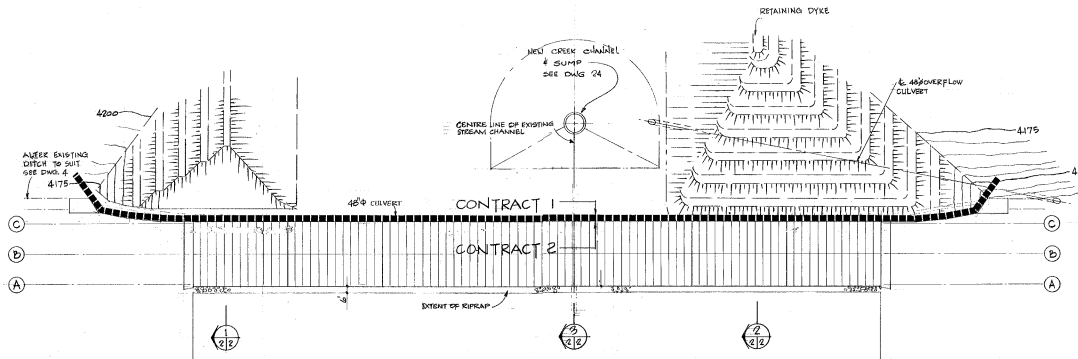

— PLAN —
SCALE - 1" = 50'-0"

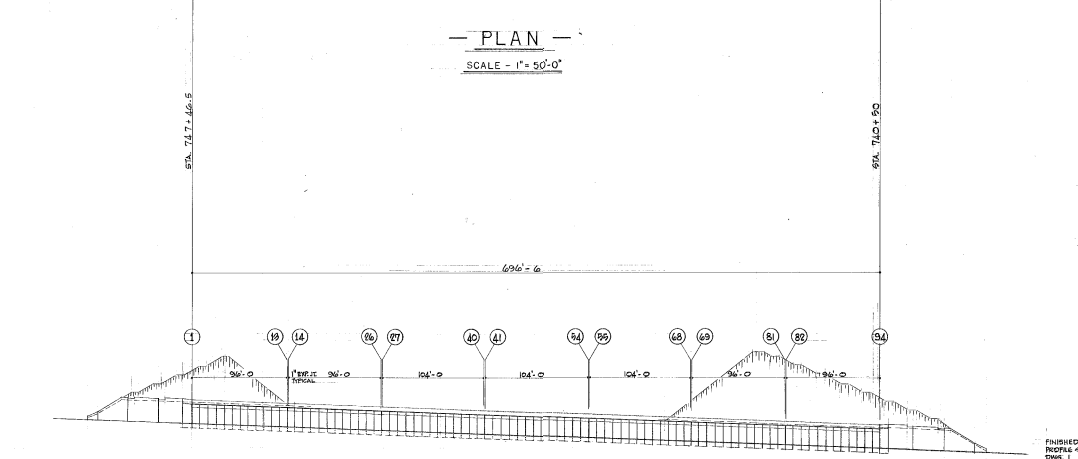

— ELEVATION —
SCALE - 1" = 50'-0"

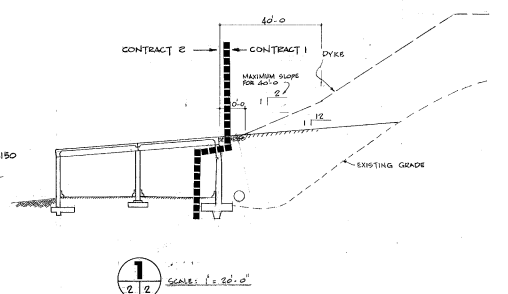

1
SCALE: 1/2" = 20'-0"

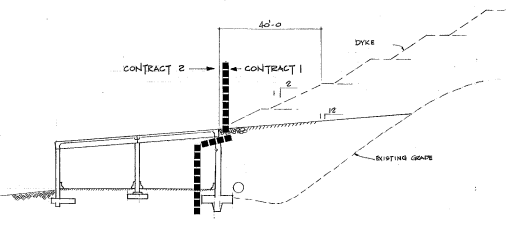

2
SCALE: 1/2" = 20'-0"

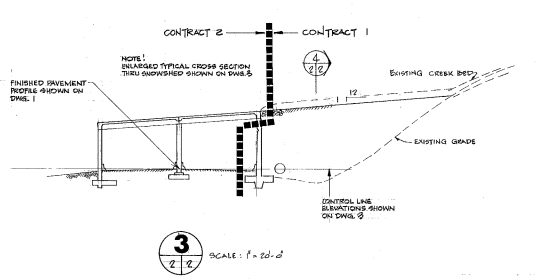

3
SCALE: 1/2" = 20'-0"

Public Works Travaux public
Canada Canada

Design and Construction
Études et Construction

Resources (civil)
Direction des ressources
(génie civil)

Structures (Bridges) Section
Section des ouvrages d'art
(ponts)

A detail no.
B location drawing no.
C drawing no.
revision no.

revisions

prime consultant



designed by
conçu par W. B. L. date
DEC. 76

checked by
examiné H. H. R. date
DEC. 76

drawn by
dessiné par B. G.

checked by
examiné H. H. R. date
DEC. 76

recommended by
recommandé par

chief bridge engineer
ingénieur en chef (ponts)

approved by
approuvé par

project manager
projet directeur

assistant director resources (civil)
directeur adjoint ressources (génie civil)

project title
titre du projet
"SINGLE BENCH"
"SNOWSHED"
GLACIER NATIONAL
PARK
B. C.

drawing title
titre du dessin

GENERAL LAYOUT



project no.
no. du projet 003885

drawing no.
dessin no. 2 de 21

CONTRACT No.2

centimetres 0 2 4 6 8 10 12 14 16 18 20 centimetres

Inches 0 1 2 3 4 5 6 7 8 POUCHES

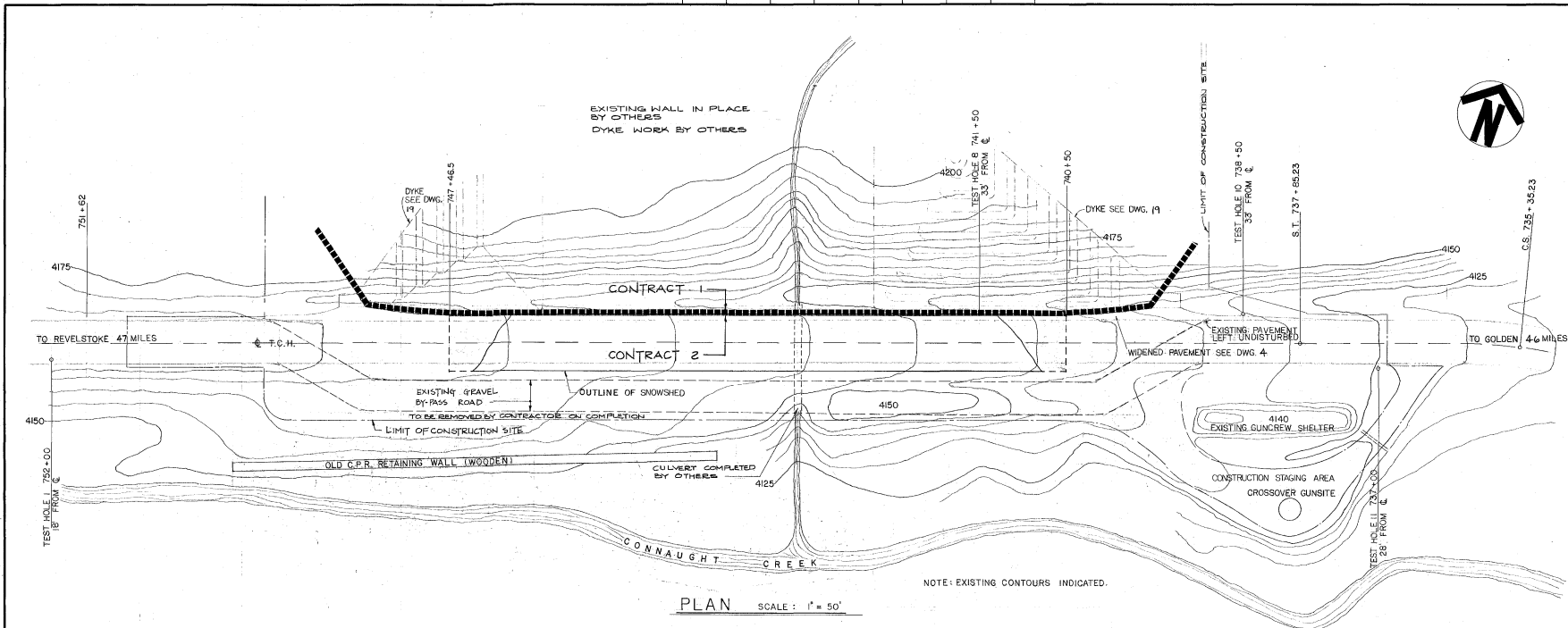

PLAN SCALE: 1" = 50'

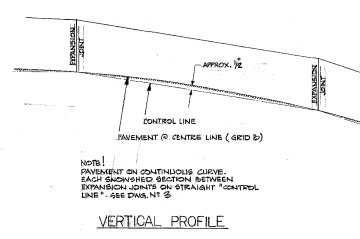
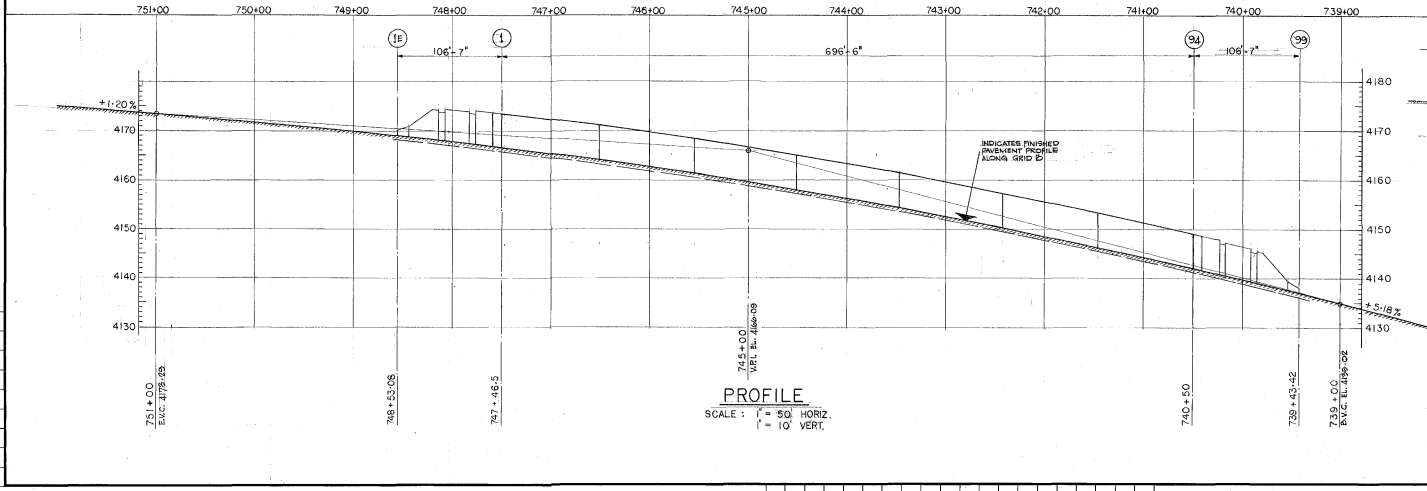

REFERENCE SURVEY DRAWING
DEPT. OF PUBLIC WORKS
CALGARY DISTRICT
DRAWING N° 2
JOB N° C.A.51-11806

Public Works Travaux public
Canada Canada

Design and Construction
Études et Construction

Resources (civil)
Direction des ressources
(génie civil)

Structures (Bridges) Section
Section des ouvrages d'art
(ponts)

A detail no.
B location drawing no.
C drawing no.
Design no.

revisions
revisions

prime consultant
DESIGN ENGINEER

designed by
conçu par W. B. LESTER date
DEC. 76

checked by
examiné H.H. RICKETTS date
DEC. 76

drawn by
dessiné par P. N.

checked by
examiné H.H. RICKETTS date
DEC. 76

recommended by
recommandé par date

chief bridge engineer
ingénieur en chef (ponts)

approved by
approuvé par date

project manager
gestionnaire de projet
project director
directeur adjoint

assistant director resources (civil)
directeur adjoint ressources (génie civil)

project title
titre du projet
SINGLE BENCH
SNOWSHED
GLACIER NATIONAL
PARK
B.C.

drawing title
titre du dessin
SITE PLAN

project no.
no. du projet 003855

drawing no.
dessin no. 1 of 21

CONTRACT No. 2

centimetres 0 2 4 6 8 10 12 14 16 18 20 centimetres

inches 0 1 2 3 4 5 6 7 8 9

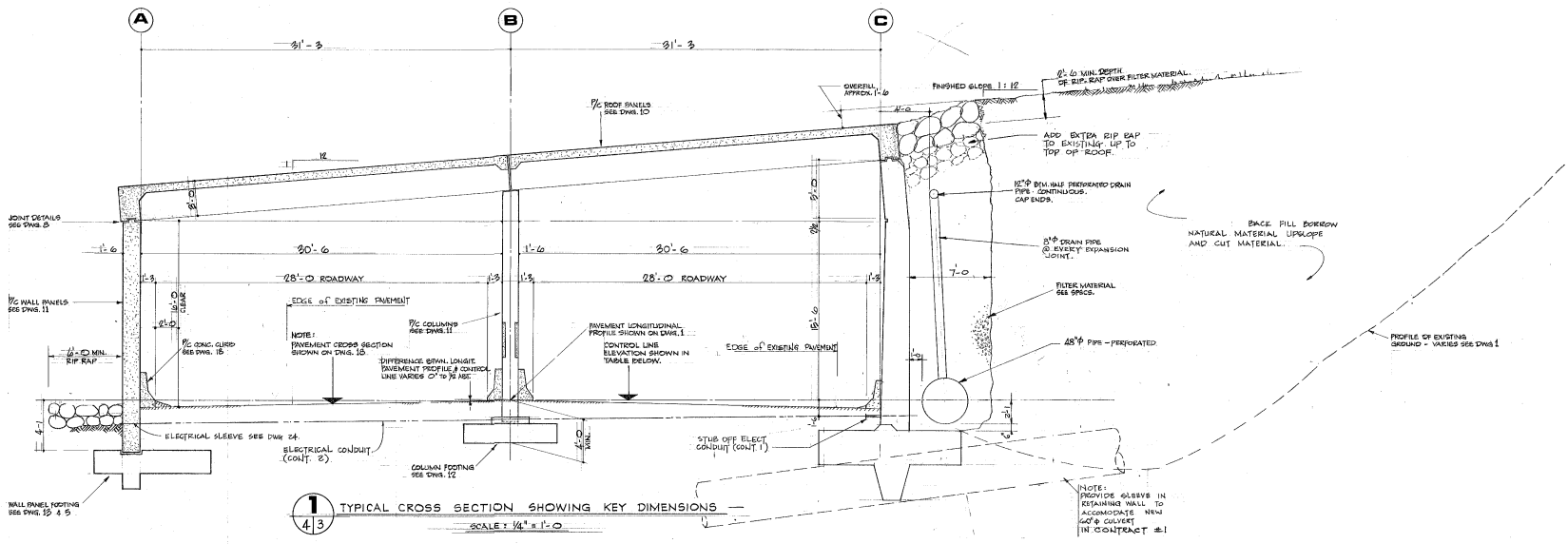

1 TYPICAL CROSS SECTION SHOWING KEY DIMENSIONS
SCALE: 1/4" = 1'-0"

STATION NO	GRID NO	CONTROL LINE ELEVATION
748+58.00	1E	4163.88
	1D	63.11 64.12
	1C	65.11 68.46
	1B	67.76
	1A	67.21
747+46.80	1	66.99
	2	66.75
	3	66.95
	4	66.98
	5	66.18
	6	65.97
	7	65.77
	8	65.57
	9	65.36
	10	65.16
	11	64.96
	12	64.76
746+30.8	13	4164.85

STATION NO	GRID NO	CONTROL LINE ELEVATION
746+50.42	14	4164.85
	15	64.85
	16	64.10
	17	63.87
	18	63.64
	19	63.41
	20	63.18
	21	62.96
	22	62.73
	23	62.50
745+54.42	24	4161.82

STATION NO	GRID NO	CONTROL LINE ELEVATION
745+54.88	27	4161.82
	28	61.86
	29	61.51
	30	61.06
	31	60.80
	32	60.54
	33	60.28
	34	60.03
	35	59.78
	36	59.52
	37	59.27
	38	59.01
	39	58.76
744+50.88	40	4158.80

STATION NO	GRID NO	CONTROL LINE ELEVATION
744+50.88	41	4158.80
	42	58.82
	43	57.94
	44	57.66
	45	57.37
	46	57.09
	47	56.81
	48	56.53
	49	56.24
	50	55.96
	51	55.68
	52	55.40
	53	55.11
743+46.08	54	4154.83

STATION NO	GRID NO	CONTROL LINE ELEVATION
743+46.17	55	4154.83
	56	54.82
	57	54.21
	58	53.90
	59	53.59
	60	53.28
	61	52.97
	62	52.66
	63	52.35
	64	52.04
	65	51.73
	66	51.42
	67	51.11
742+42.17	68	4150.80

STATION NO	GRID NO	CONTROL LINE ELEVATION
742+42.08	69	4150.80
	70	50.46
	71	50.13
	72	49.79
	73	49.45
	74	49.12
	75	48.78
	76	48.44
	77	48.11
	78	47.77
	79	47.43
	80	47.10
741+46.08	81	4146.76

STATION NO	GRID NO	CONTROL LINE ELEVATION
741+46.00	82	4146.76
	83	46.40
	84	46.04
	85	45.68
	86	45.31
	87	44.95
	88	44.59
	89	44.23
	90	43.86
	91	43.50
	92	43.14
	93	42.78
	94	42.42
	95	41.98
	96	40.83
	97	39.29
	98	37.74
740+43.50	99	4137.24

Date

Public Works Travaux public
Canada Canada

Design and Construction
Études et construction

Resources (civil)
Directeur des ressources
(génie civil)

Structures (Bridges) Section
Section des ouvrages d'art
(ponts)

A detail no.
B location drawing no.
C drawing no.

revisions
revisions

prime consultant
CONSULTING ENGINEERS
INCORPORATED
1000 UNIVERSITY AVENUE
TORONTO, ONTARIO
M5G 1A7
ON

designed by
conçu par W. B. L. date
DEC. 76

checked by
examiné H. H. R. date
DEC 76

drawn by
dessiné par B. G.

checked by
examiné H. H. R. date
DEC. 76

recommended by
recommandé par date

chief bridge engineer
ingénieur en chef (ponts)

approved by
approuvé par date

project manager
projet directeur

assistant director resources (civil)
directeur adjoint ressources (génie civil)

project title
titre du projet
"SINGLE BENCH"
SNOWSHED
GLACIER NATIONAL
PARK
B.C.

drawing title
titre du dessin
TYPICAL SECTION
& LAYOUT DATA

project no.
no. du projet 003855

drawing no.
dessin no. 3 of 21

centimetres 0 2 4 6 8 10 12 14 16 18 20

inches 0 1 2 3 4 5 6 7 8 pouces

Public Works / Travaux publics Canada

Design and Construction
Études et Construction

Resources (civil)
Direction des ressources (génie civil)

Structures (Bridges) Section
Section des ouvrages d'art (ponts)

A detail no. / détail no.
B location drawing no. / sur dessin no.
C drawing no. / dessin no.

revisions / révisions

prime consultants
RICKETTS EVERS BARRASS SIMPSON
Engineering / management consultants
calgary

designed by / conçu par **W.B.L.** date **DEC. 76**
checked by / examiné par **H.H.R.** date **DEC. 76**
drawn by / dessiné par **S. D.**
checked by / examiné par **H.H.R.** date **DEC. 76**
recommended by / recommandé par
chief bridge engineer / ingénieur en chef (ponts)
approved by / approuvé par
assistant director / directeur adjoint resources (civil) / ressources (génie civil)

project title / titre du projet
'SINGLE BENCH' SNOWSHED
GLACIER NATIONAL PARK B.C.

drawing title / titre du dessin
PLAN & ELEVATION OF EASTERN WING WALL.

project no. / no. du projet **Q27867**
drawing no. / dessin no. **3A** of **8**

CONTRACT No. 1 ALT. A

4 IN KEY TO WATERSTOP & WATERPROOFING JOINT SEALER @ ALL CONST. JOINTS.

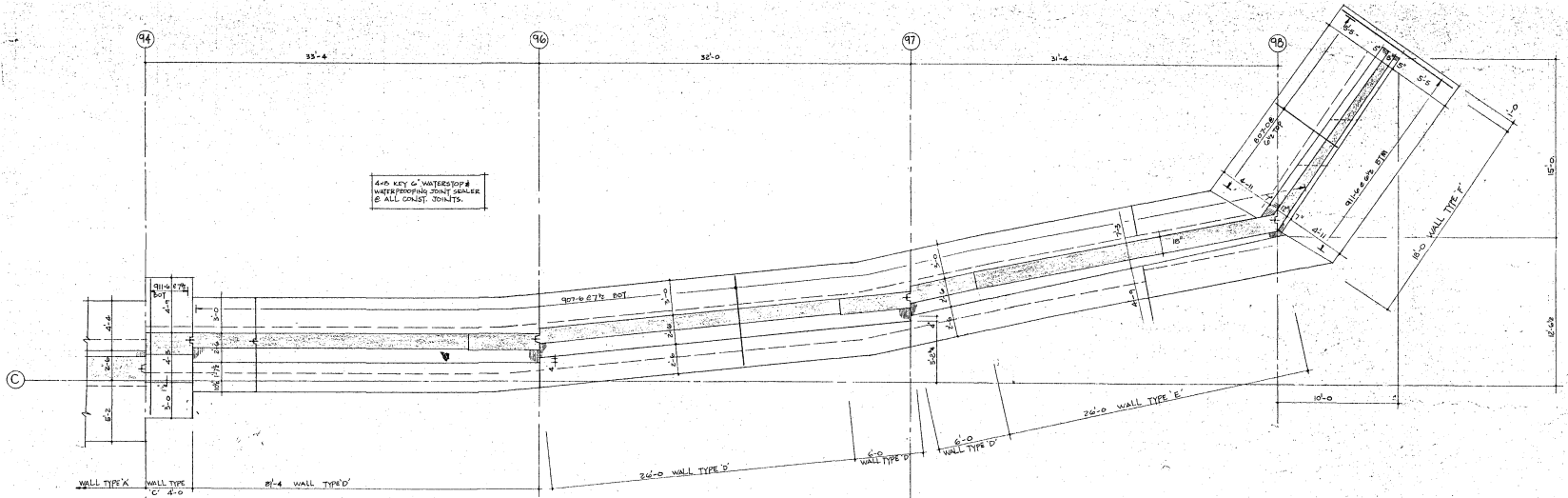

1 PLAN
SCALE 1/4" = 1'-0"

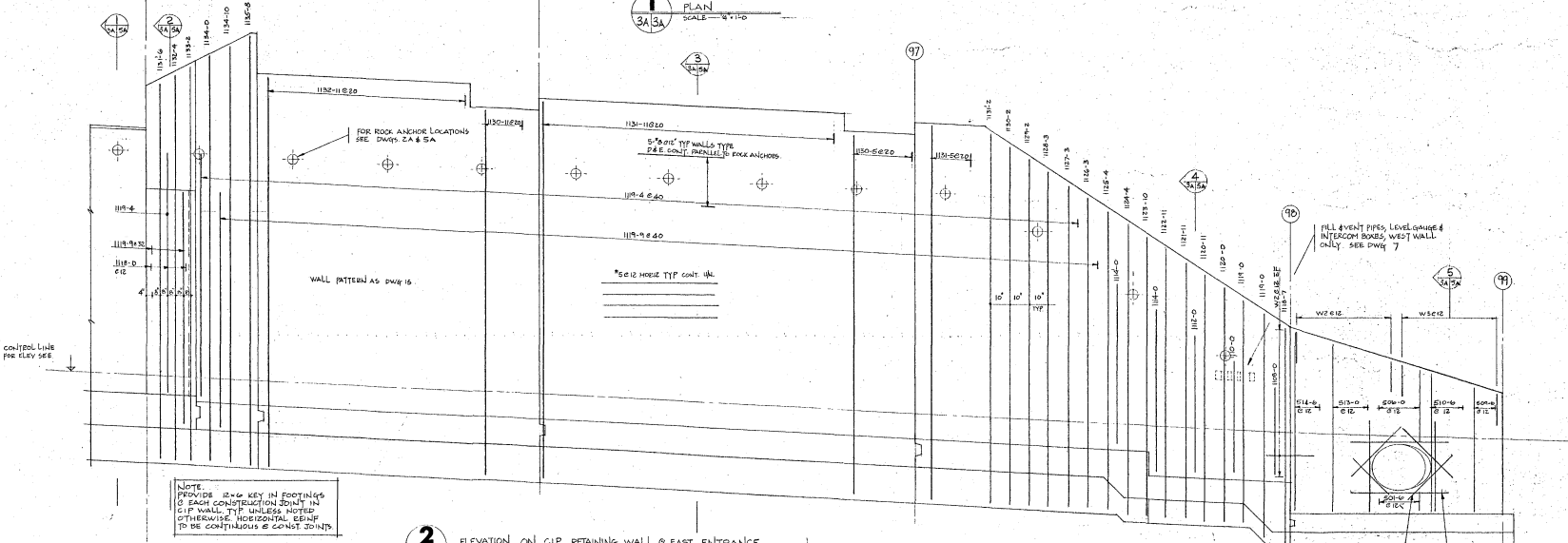

2 ELEVATION ON C.I.P. RETAINING WALL @ EAST ENTRANCE
WEST ENTRANCE SIMILAR SHOWING NEAR FACE BEING
SCALE 1/4" = 1'-0"

NOTE: PROVIDE 2 IN KEY IN FOOTINGS TO EACH CONSTRUCTION JOINT IN C.I.P. WALL, TYP UNLESS NOTED OTHERWISE. HORIZONTAL BEARING TO BE CONTINUOUS @ CONST JOINTS.

Date

centimetres 0 2 4 6 8 10 12 14 16 18 20 centimetres

inches 0 1 2 3 4 5 6 7 8 pouces

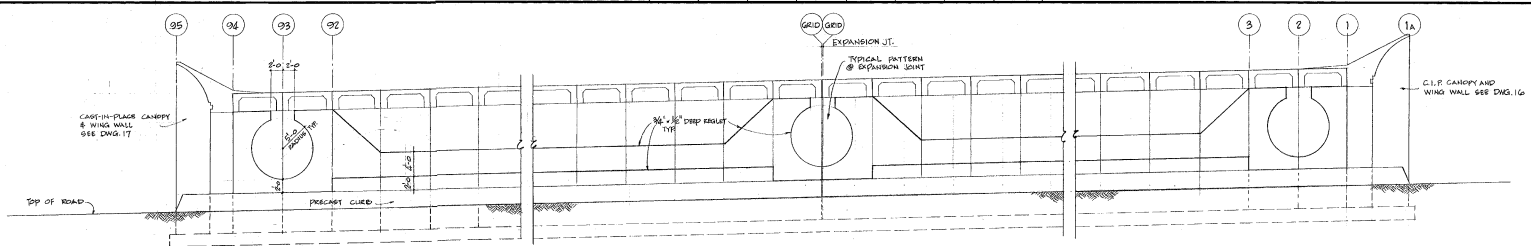

1
15 15
INTERIOR ELEVATION - P.C. WALL PANELS @ GRID A
SCALE: 1/8" = 1'-0"

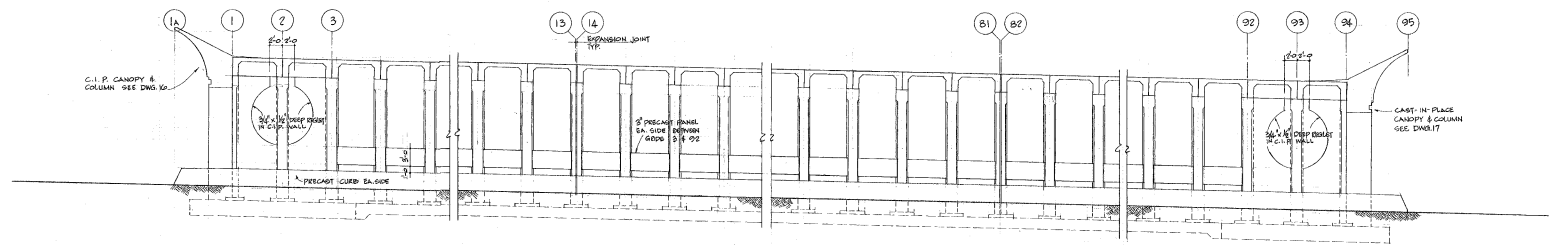

2
15 15
COLUMN ELEVATION @ GRID B - SHOWING PRECAST CONC. RAILS
OTHER SIDE SIMILAR

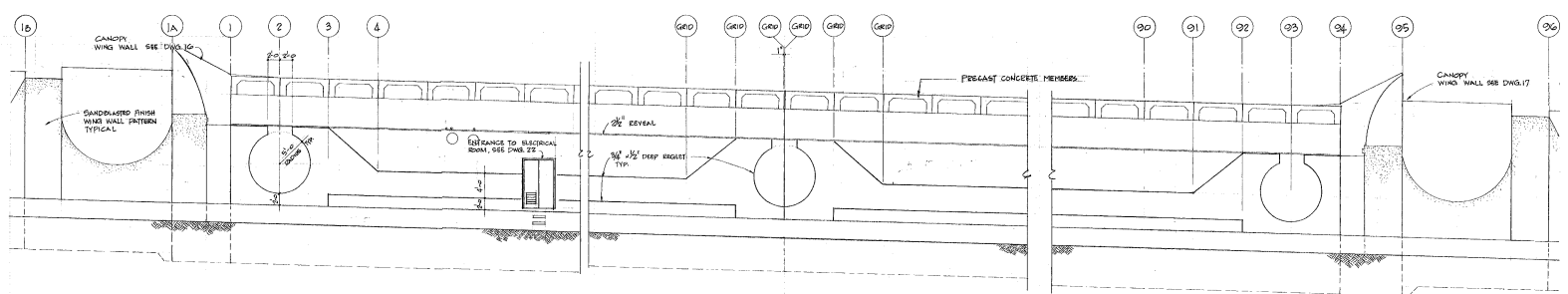

3
15 15
INTERIOR ELEVATION - RETAINING WALL @ GRID C. (CONTRACT 1)

centimetres 0 2 4 6 8 10 12 14 16 18 20 centimetres

Public Works / Travaux publics
Canada / Canada

Design and Construction
Études et Construction

Resources (civil)
Direction des ressources
(génie civil)

Structures (Bridges) Section
Section des ouvrages d'art
(ponts)

A. detail no.
B. location drawing no.
C. drawing no.
Detail no.
Sheet no.

revisions
révisions

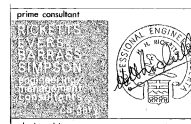

designed by
congé par
date
DEC. 76

checked by
examiné
date
DEC. 76

drawn by
dessiné par
date
DEC. 76

checked by
examiné
date
DEC. 76

recommended by
recommandé par
date

chief bridge engineer
ingénieur en chef (ponts)

approved by
approuvé par
date

project manager
proj. directeur

assistant director resources (civil)
directeur adjoint ressources (génie civil)

project title
titre du projet
"SINGLE BENCH"
SNOWSHED
GLACIER NATIONAL
PARK
B.C.

drawing title
titre du dessin
AA001829

INTERIOR ELEVATIONS

project no.
no. du projet
003855

drawing no.
dessin no.
15 of 21

CONTRACT No. 2

Appendix G – BC MoTI

This appendix contains the details on two BC MoTI snow sheds

G1. Great Bear (built 1986)

4 pages with site plan, elevation and cross-section drawings.

CONTINUATION OF
SLOPE TREATMENT
BY CONTRACTOR. ROCK
EXCAVATION NOT REQ'D

SLOPE TREATMENT
REQUIRING ROCK
BLASTING BY OTHERS

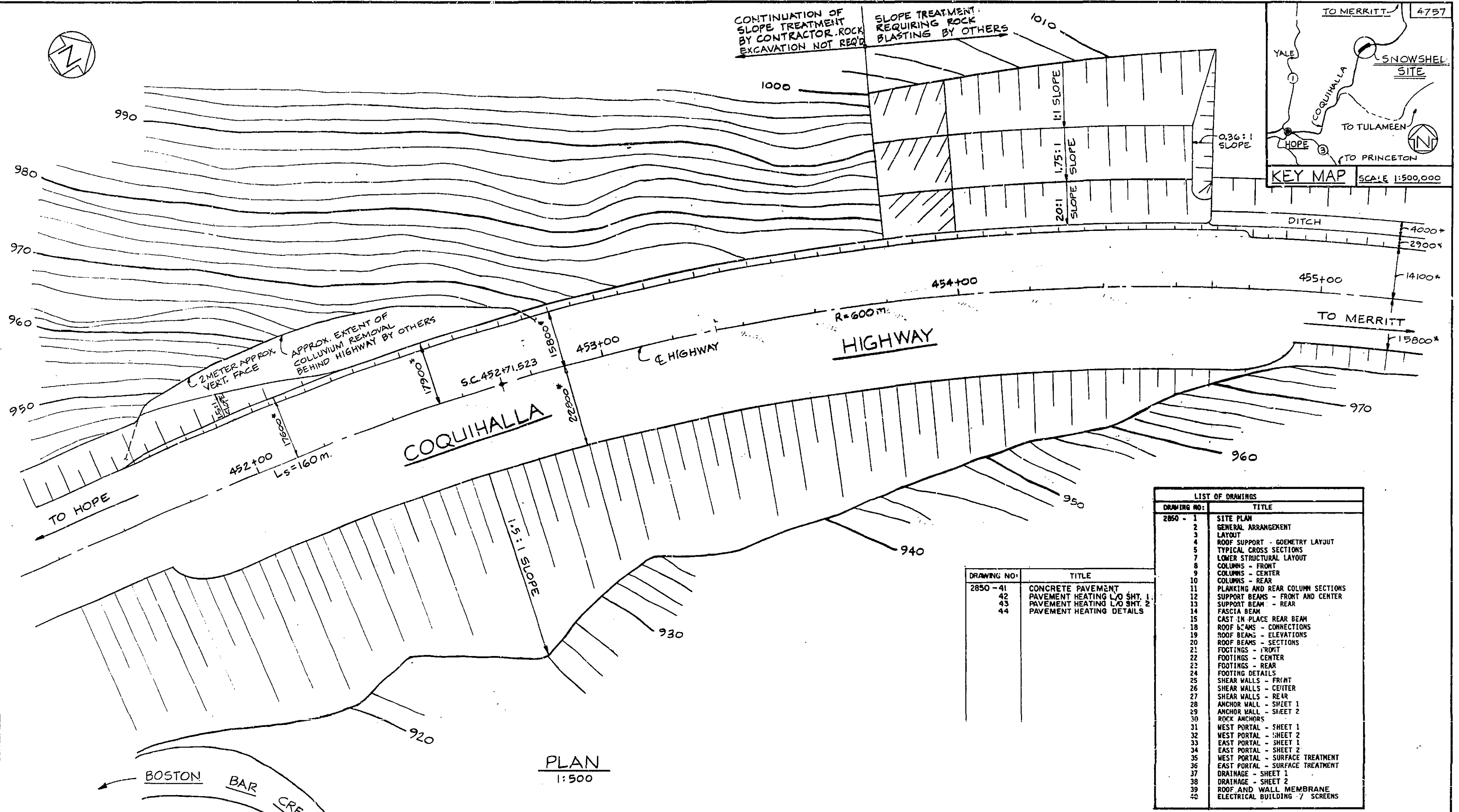
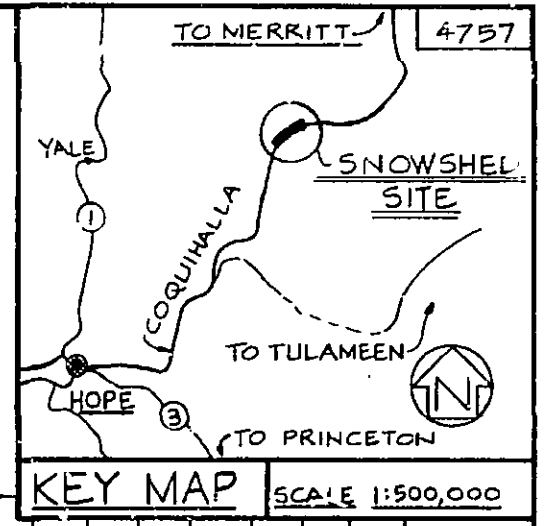

PLAN
1:500

DRAWING NO.	TITLE
2850-41	CONCRETE PAVEMENT
42	PAVEMENT HEATING L/O SHT. 1.
43	PAVEMENT HEATING L/O SHT. 2.
44	PAVEMENT HEATING DETAILS

LIST OF DRAWINGS	
DRAWING NO.	TITLE
2850-1	SITE PLAN
2	GENERAL ARRANGEMENT
3	LAYOUT
4	ROOF SUPPORT - GEOMETRY LAYOUT
5	TYPICAL CROSS SECTIONS
7	LOWER STRUCTURAL LAYOUT
8	COLUMNS - FRONT
9	COLUMNS - CENTER
10	COLUMNS - REAR
11	PLANKING AND REAR COLUMN SECTIONS
12	SUPPORT BEAMS - FRONT AND CENTER
13	SUPPORT BEAM - REAR
14	FASCIA BEAM
15	CAST IN PLACE REAR BEAM
16	ROOF BEAMS - CONNECTIONS
18	ROOF BEAMS - ELEVATIONS
19	ROOF BEAMS - SECTIONS
20	ROOF BEAMS - SECTIONS
21	FOOTINGS - FRONT
22	FOOTINGS - CENTER
23	FOOTINGS - REAR
24	FOOTING DETAILS
25	SHEAR WALLS - FRONT
26	SHEAR WALLS - CENTER
27	SHEAR WALLS - REAR
28	ANCHOR WALL - SHEET 1
29	ANCHOR WALL - SHEET 2
30	ROCK ANCHORS
31	WEST PORTAL - SHEET 1
32	WEST PORTAL - SHEET 2
33	EAST PORTAL - SHEET 1
34	EAST PORTAL - SHEET 2
35	WEST PORTAL - SURFACE TREATMENT
36	EAST PORTAL - SURFACE TREATMENT
37	DRAINAGE - SHEET 1
38	DRAINAGE - SHEET 2
39	ROOF AND WALL MEMBRANE
40	ELECTRICAL BUILDING / SCREENS

NOTES:

- 1) SURVEY INFORMATION TAKEN FROM UNDERWOOD AND McLELLAN LTD. DWG. NOS. R1-169-09, 47, 73 AND 74.
- 2) * TO BE VERIFIED ON SITE.
- 3) FOR LOCATION OF RIGHT OF WAY SEE UNDERWOOD AND McLELLAN LTD. DWG. NOS. R1-169-49 AND 40.
- 4) ROADWAY IN ZONE OF SHED HAS BEEN CONSTRUCTED TO 1200 mm BELOW FINISHED GRADE.

GOVERNMENT OF BRITISH COLUMBIA
MINISTRY OF TRANSPORTATION AND HIGHWAYS
BRIDGE ENGINEERING BRANCH

HOPE DISTRICT
COQUIHALLA HIGHWAY
GREAT BEAR SNOW SHED
SITE PLAN

PREPARED UNDER THE DIRECTION OF: *S. Maranda* DATE: _____ SCALE: AS NOTED NEG. No. 296216
DRAWN: W.J.F. CHECKED: _____
APPROVED FOR USE IN CONSTRUCTION: *S. G. Johnson* DATE: 25.05.74 EXAMINED AND ACCEPTED: *M. G. E. McElen* DATE: _____ DRAWING No. 2850-1
DIRECTOR OF BRIDGE ENGINEERING EXECUTIVE DIRECTOR OF ENGINEERING

CW MM CHOUKALOS WOODBURN MCKENZIE MARANDA CONSULTING ENGINEERS

REVISIONS	DATE	DESCRIPTION
D		
C		
B		
A		

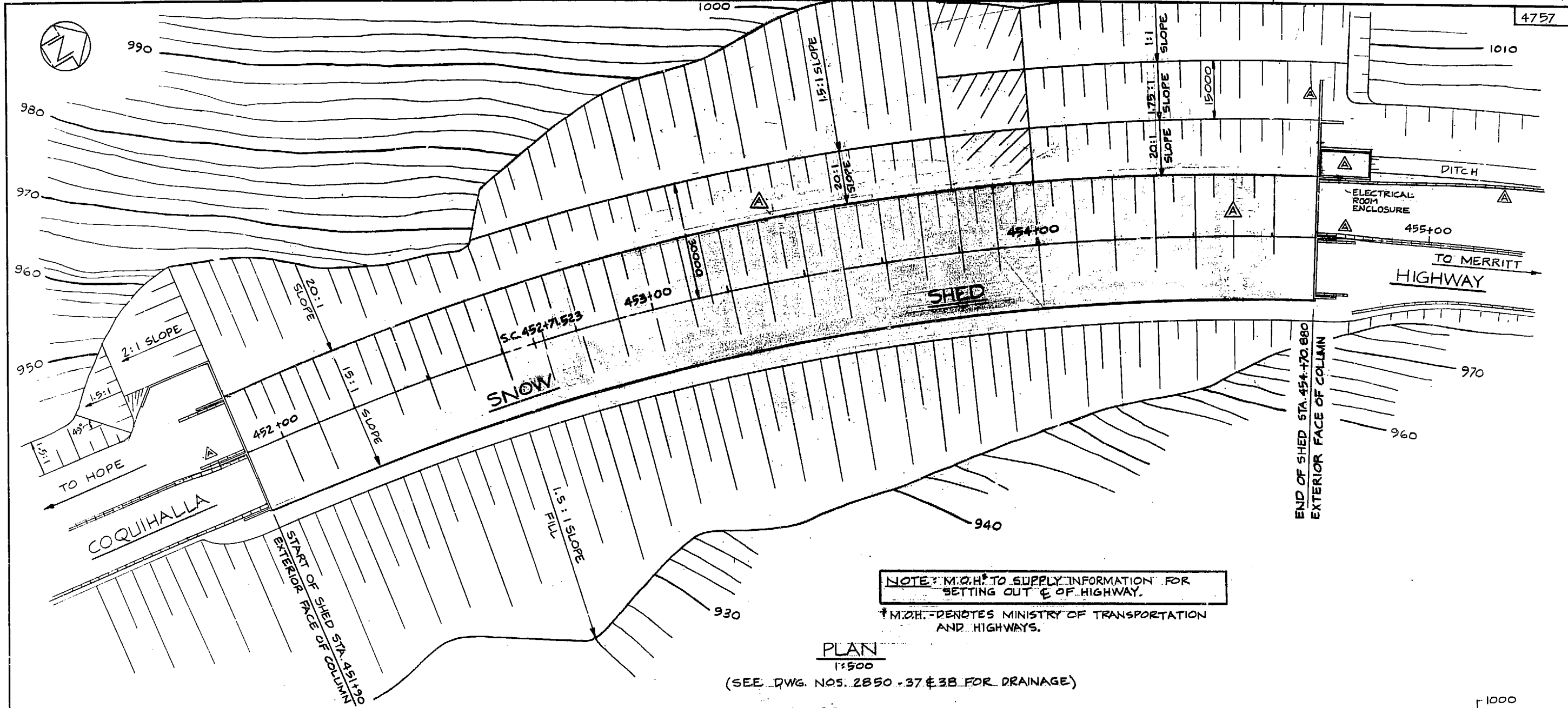

NOTE: M.O.H. TO SUPPLY INFORMATION FOR SETTING OUT OF HIGHWAY.
 *M.O.H. DENOTES MINISTRY OF TRANSPORTATION AND HIGHWAYS.

PLAN
 1:500
 (SEE DWG. NOS. 2850-37 & 38 FOR DRAINAGE)

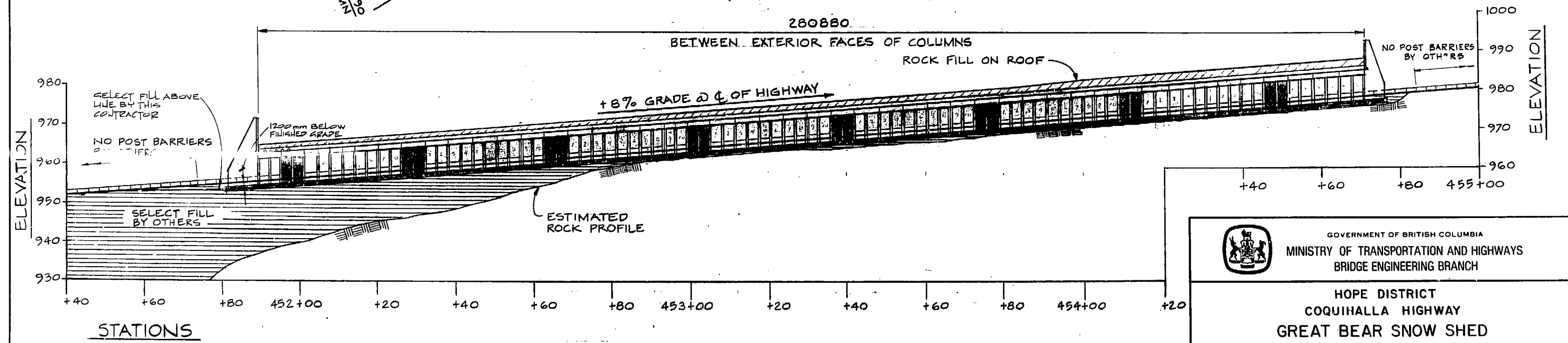

PROFILE
 1:300

GOVERNMENT OF BRITISH COLUMBIA
 MINISTRY OF TRANSPORTATION AND HIGHWAYS
 BRIDGE ENGINEERING BRANCH

HOPE DISTRICT
 COQUIHALLA HIGHWAY
 GREAT BEAR SNOW SHED
 GENERAL ARRANGEMENT

PREPARED UNDER THE DIRECTION OF	DATE	SCALE: AS NOTED	NEG No	296217
<i>S. J. Branda</i>		DRAWN	W.J.F.	CHECKED
APPROVED FOR USE IN CONSTRUCTION	DATE	EXAMINED AND ACCEPTED	DATE	DRAWING No.
<i>A.S. BUILT REVISIONS</i>	GT 15/06	<i>MGE</i>	1985 03 25	2850-2, A

CANCEL PRINTS BEARING EARLIER LETTER

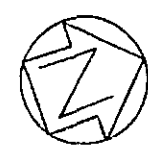

NOTE: DIMENSIONS SHOWN ARE ALONG CENTER LINE OF THE SNOW SHED AND HIGHWAY. DIMENSIONING IS IN THE VERTICAL AND HORIZONTAL PLANES.

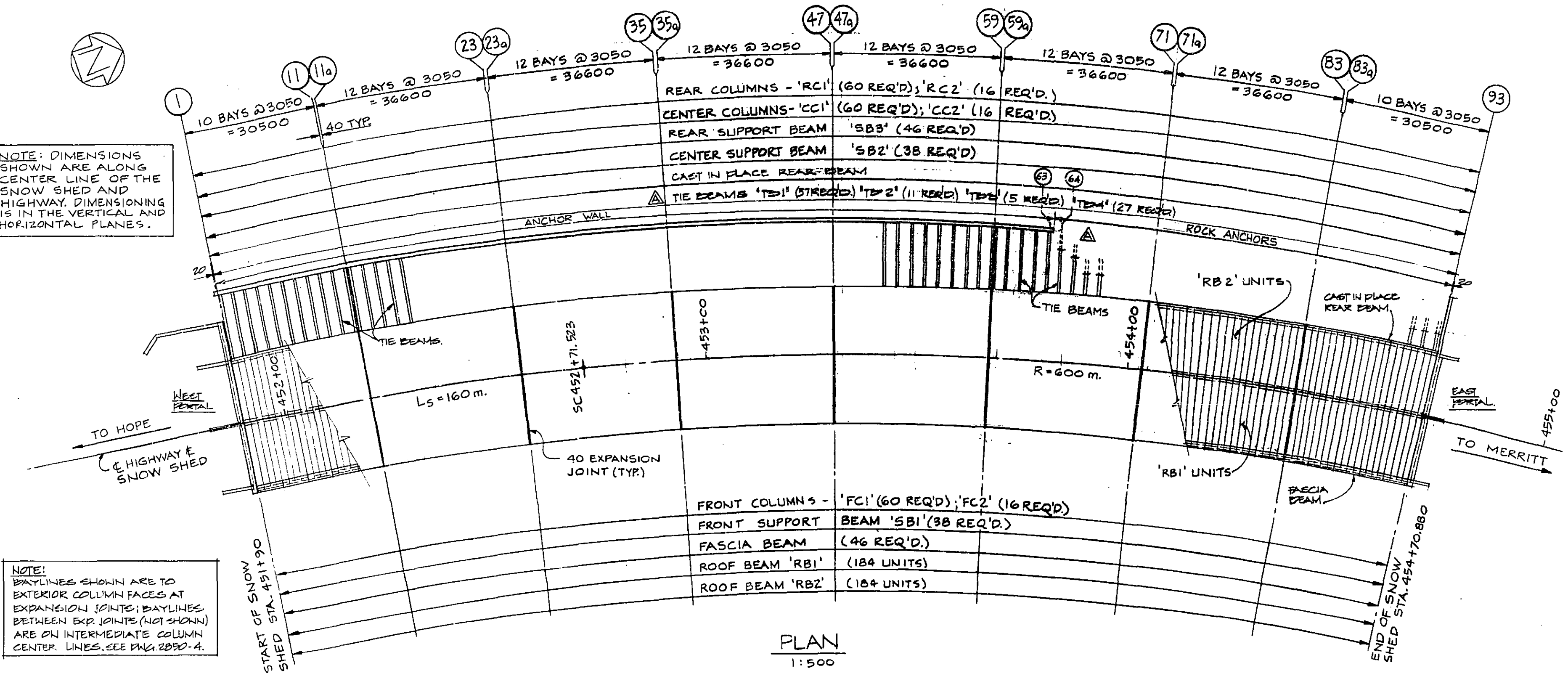

NOTE: BAYLINES SHOWN ARE TO EXTERIOR COLUMN FACES AT EXPANSION JOINTS; BAYLINES BETWEEN EXP. JOINTS (NOT SHOWN) ARE ON INTERMEDIATE COLUMN CENTER LINES. SEE PNG. 2850-4.

PLAN
1:500

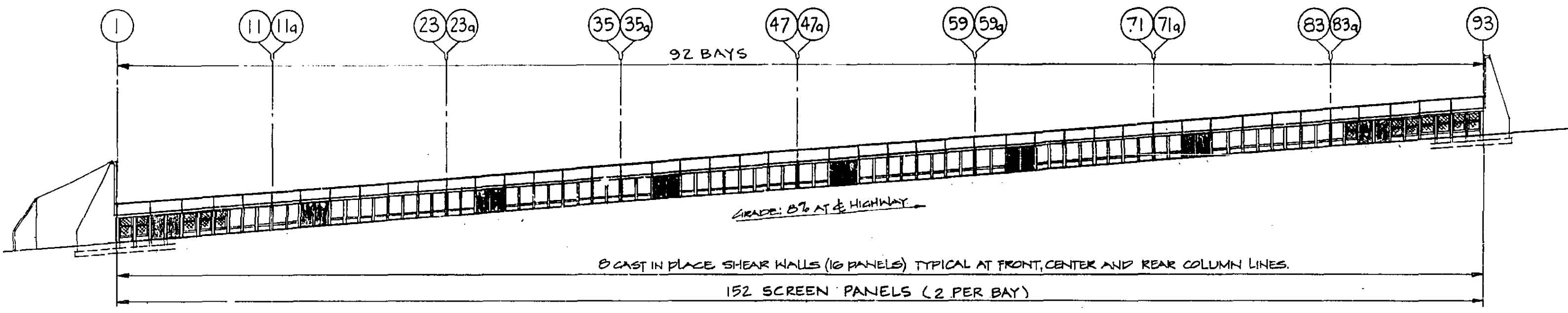

FRONT ELEVATION
1:500

GOVERNMENT OF BRITISH COLUMBIA
 MINISTRY OF TRANSPORTATION AND HIGHWAYS
 BRIDGE ENGINEERING BRANCH

HOPE DISTRICT
 COQUIHALLA HIGHWAY
 GREAT BEAR SNOW SHED
 LAYOUT

PREPARED UNDER THE DIRECTION OF	DATE	SCALE: AS NOTED	NEG. No. 296218
W. J. F.			
APPROVED FOR USE IN CONSTRUCTION	DATE	EXAMINED AND ACCEPTED	DATE
	25.01.11		

DRAWING No. 2850 3 A

ISSUED FOR PRECAST MEMBERS - FEB. 14, 1985
 ISSUED FOR ROOF BEAMS - JAN. 9, 1985

CW MIM
 CHOUKALOS
 WOODBURN
 MCKENZIE
 MARANDA
 CONSULTING
 ENGINEERS

D			
C			
B			
A	AS BUILT REVISIONS	GT	18/07/85

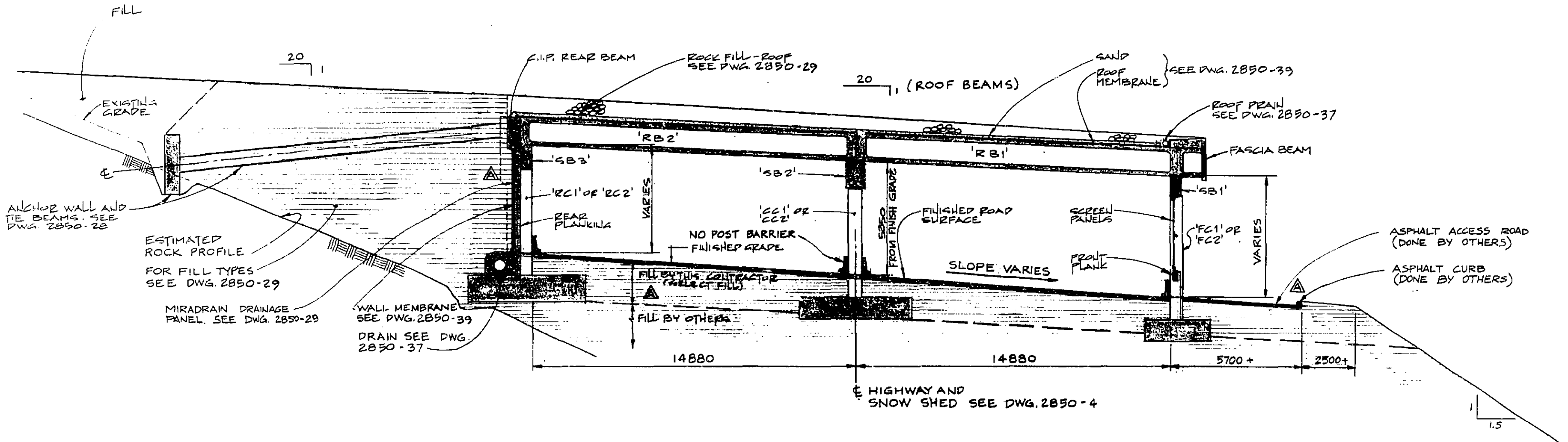

TYPICAL CROSS-SECTION ON FILL
1:100

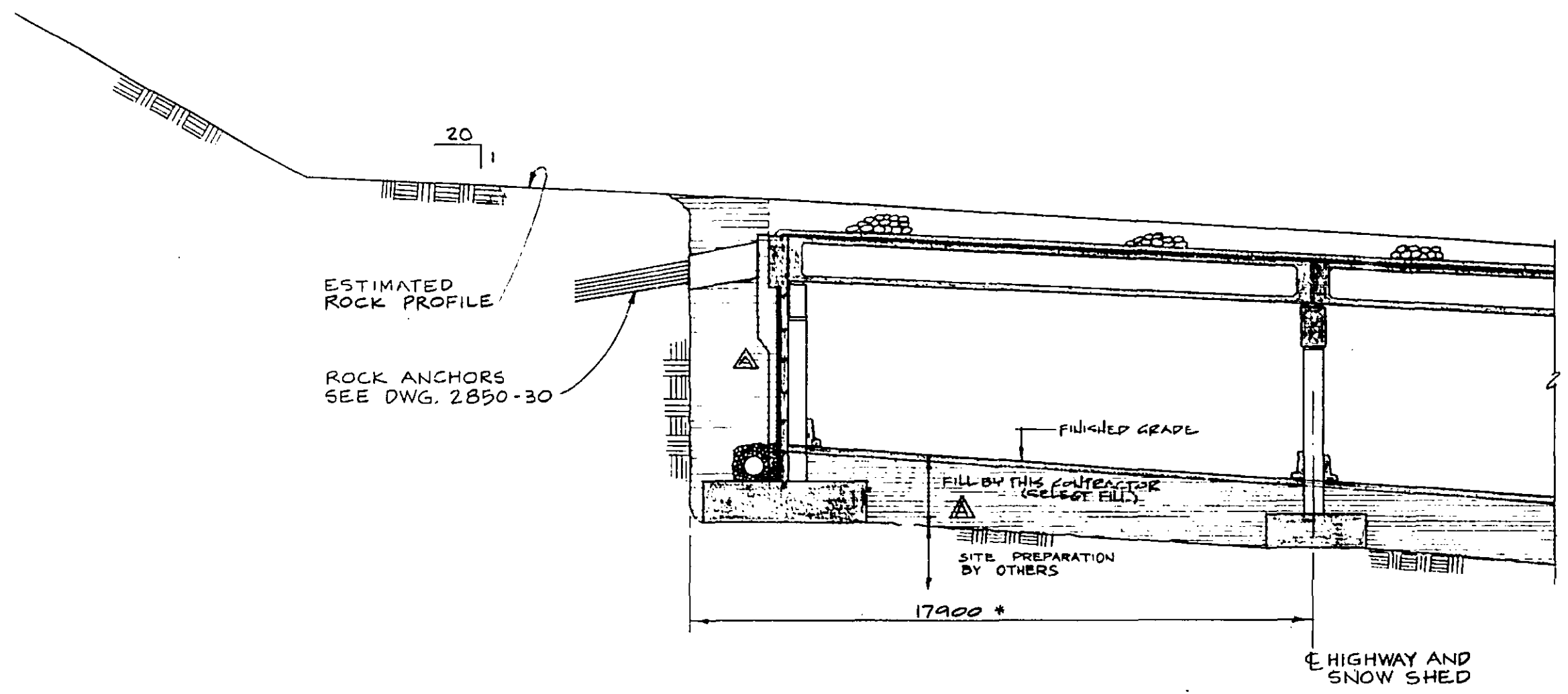

TYPICAL CROSS-SECTION ON ROCK
1:100
(SIMILAR TO CROSS-SECTION ON FILL UNLESS SHOWN OTHERWISE).

NOTE:
* TO BE VERIFIED ON SITE.

		GOVERNMENT OF BRITISH COLUMBIA MINISTRY OF TRANSPORTATION AND HIGHWAYS BRIDGE ENGINEERING BRANCH			
		HOPE DISTRICT COQUIHALLA HIGHWAY GREAT BEAR SNOW SHED TYPICAL CROSS-SECTIONS			
PREPARED UNDER THE DIRECTION OF CONSULTING ENGINEER	DATE 25.12.28	SCALE: AS NOTED	NEG. No. 296220	DRAWN W.J.F.	CHECKED
APPROVED FOR USE IN CONSTRUCTION DIRECTOR OF BRIDGE ENGINEERING	DATE 25.12.28	EXAMINED AND ACCEPTED M. G. G. G. EXECUTIVE DIRECTOR OF ENGINEERING	DATE 25.12.28	DRAWING No. 2850-5 A	CANCEL PRINTS BEARING EARLIER LETTER

CW | **CHOUKALOS**
MM | **WOODBURN**
 CONSULTING ENGINEERS | **MCKENZIE**
 | **MARANDA**

D			
C			
B			
A	AS BUILT REVISIONS	GT	10/26
	REVISIONS		

G2. Lannark (built 1962)

3 pages with site plan, cross-section and wing wall and dyke drawings

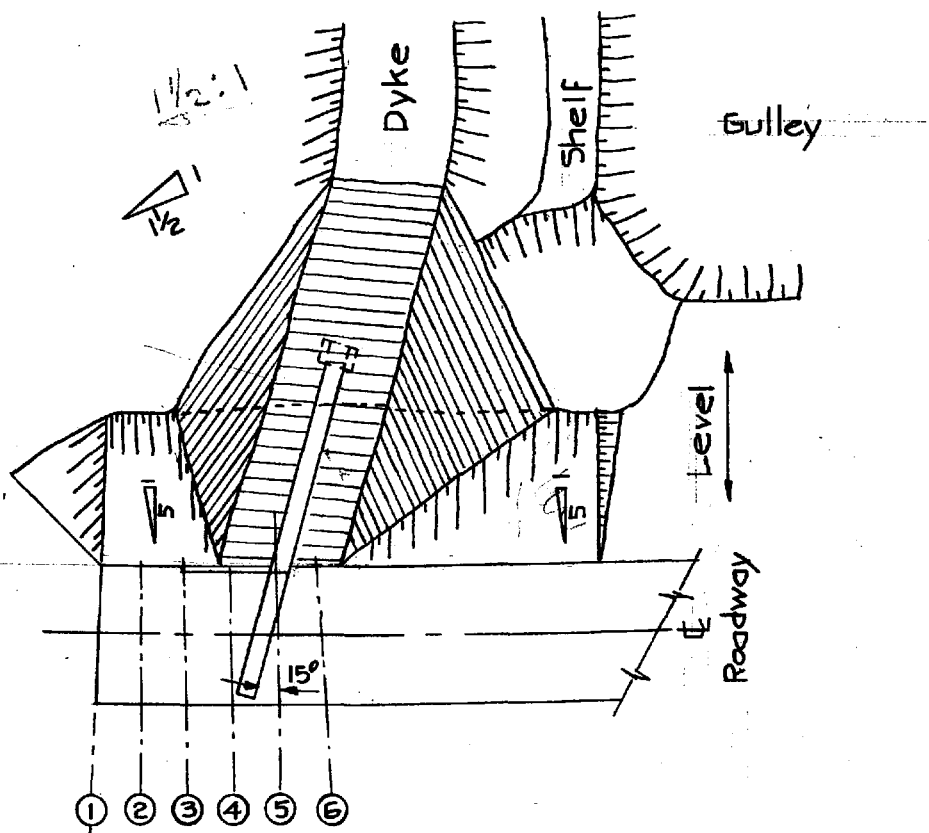

West Portal
Ch. 550+22.6

WEST DYKE

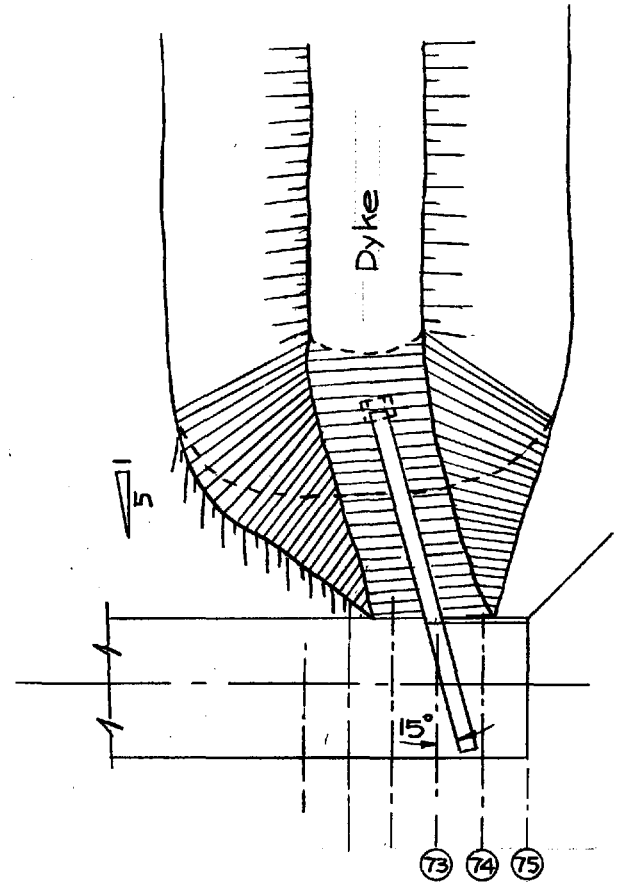

East Portal
Ch. 560+50.0

EAST DYKE

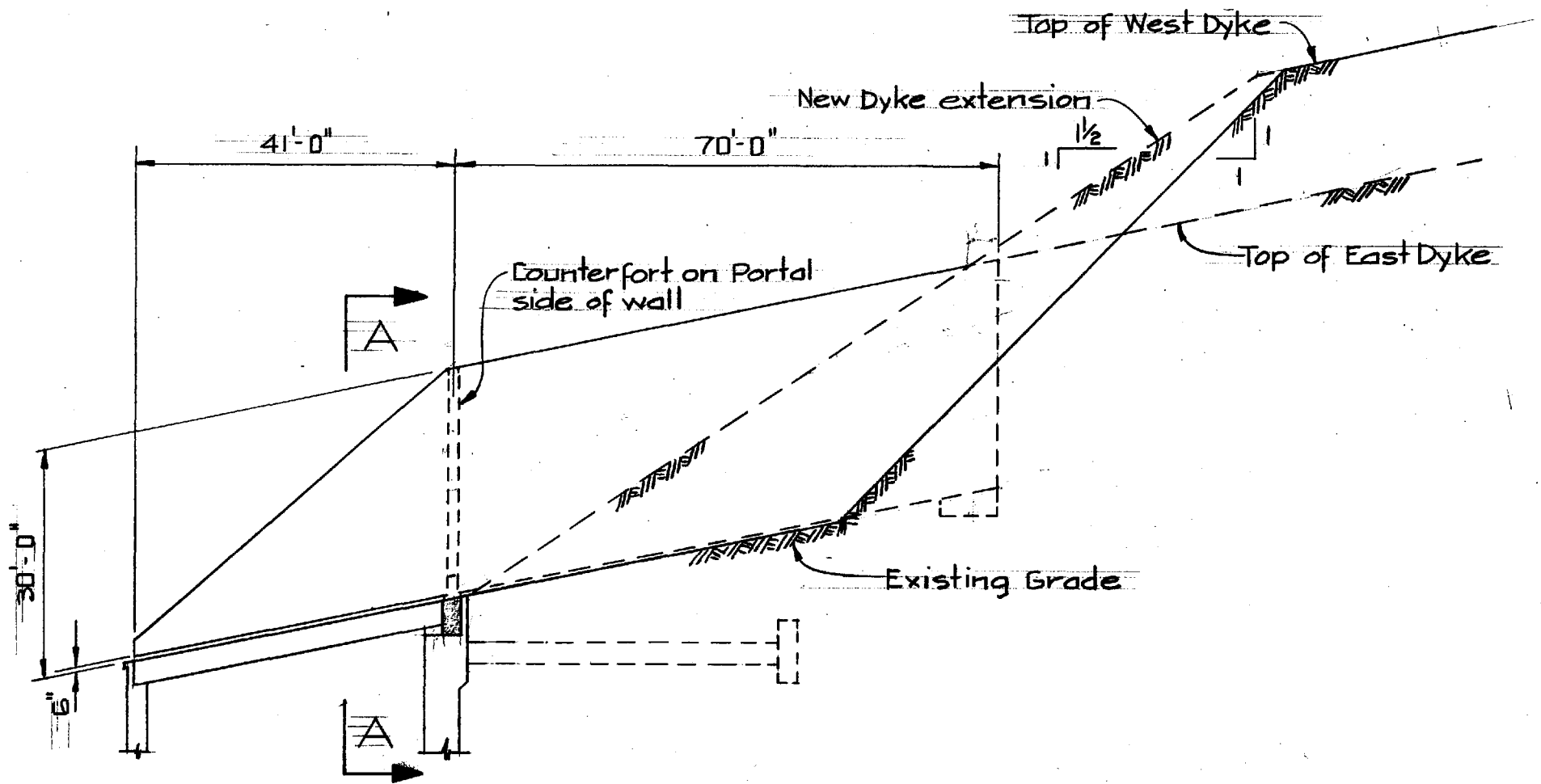

SECTION THROUGH SHED AT DYKE

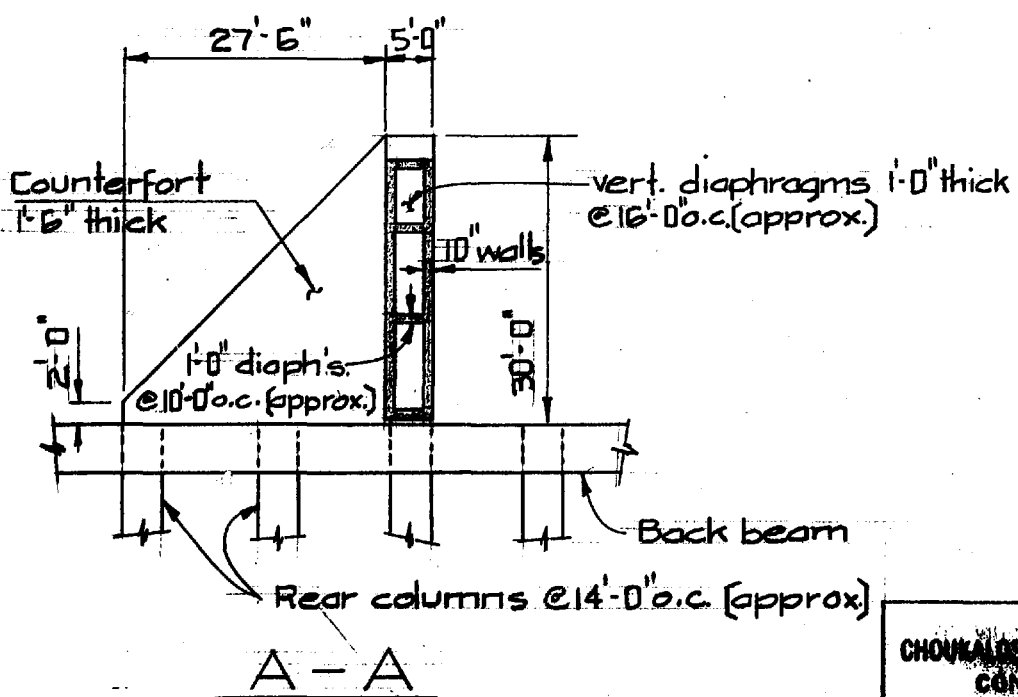

NOTE

Location and size of existing Dykes are assumed only and must be verified by a survey.

54897

CHOWKALD, WOODBURN, & MCKENZIE LTD.
CONSULTING ENGINEERS
1666 WEST BROADWAY
VANCOUVER 9, B. C.

Construction on Shed Roof
Lonark Shed
Proposal No. 2

April, 1963 Sk-1696-4

2

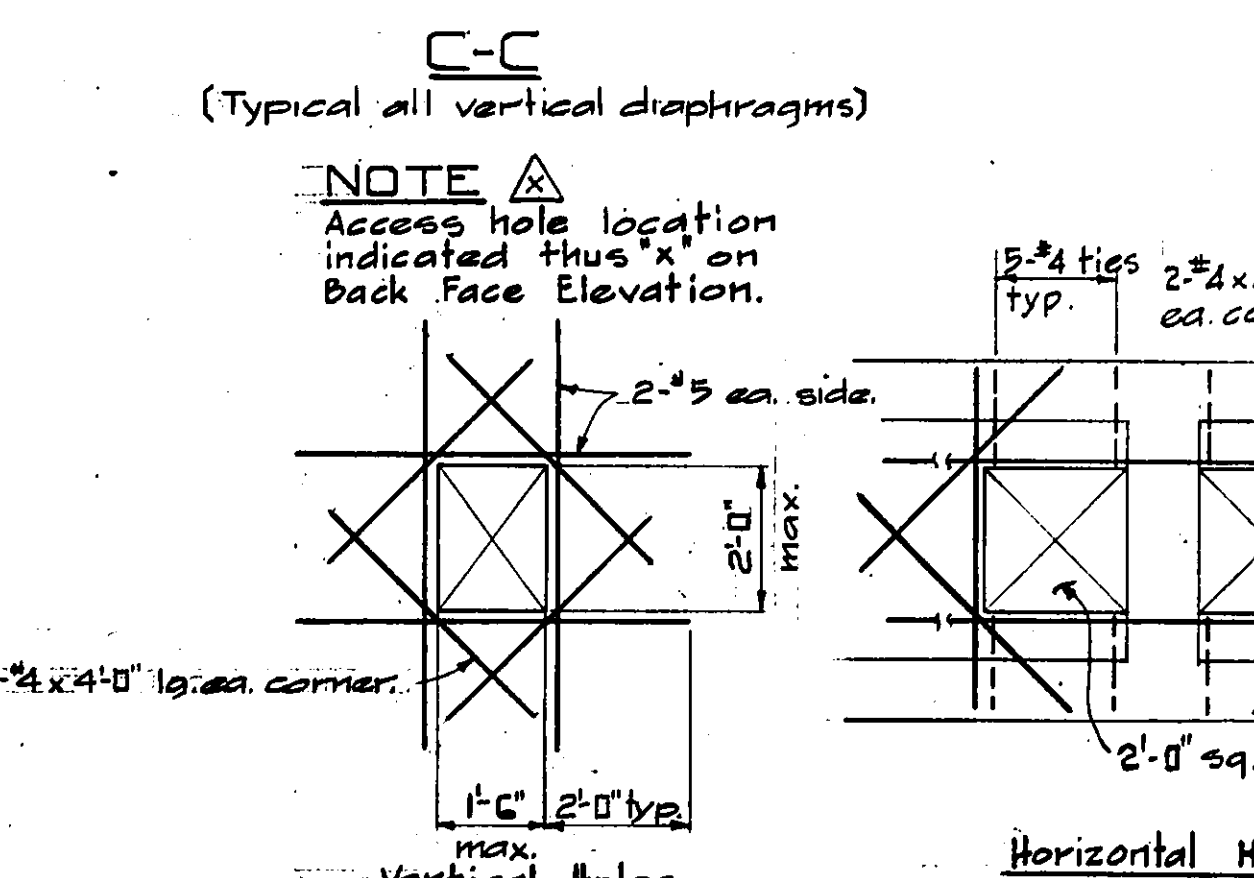
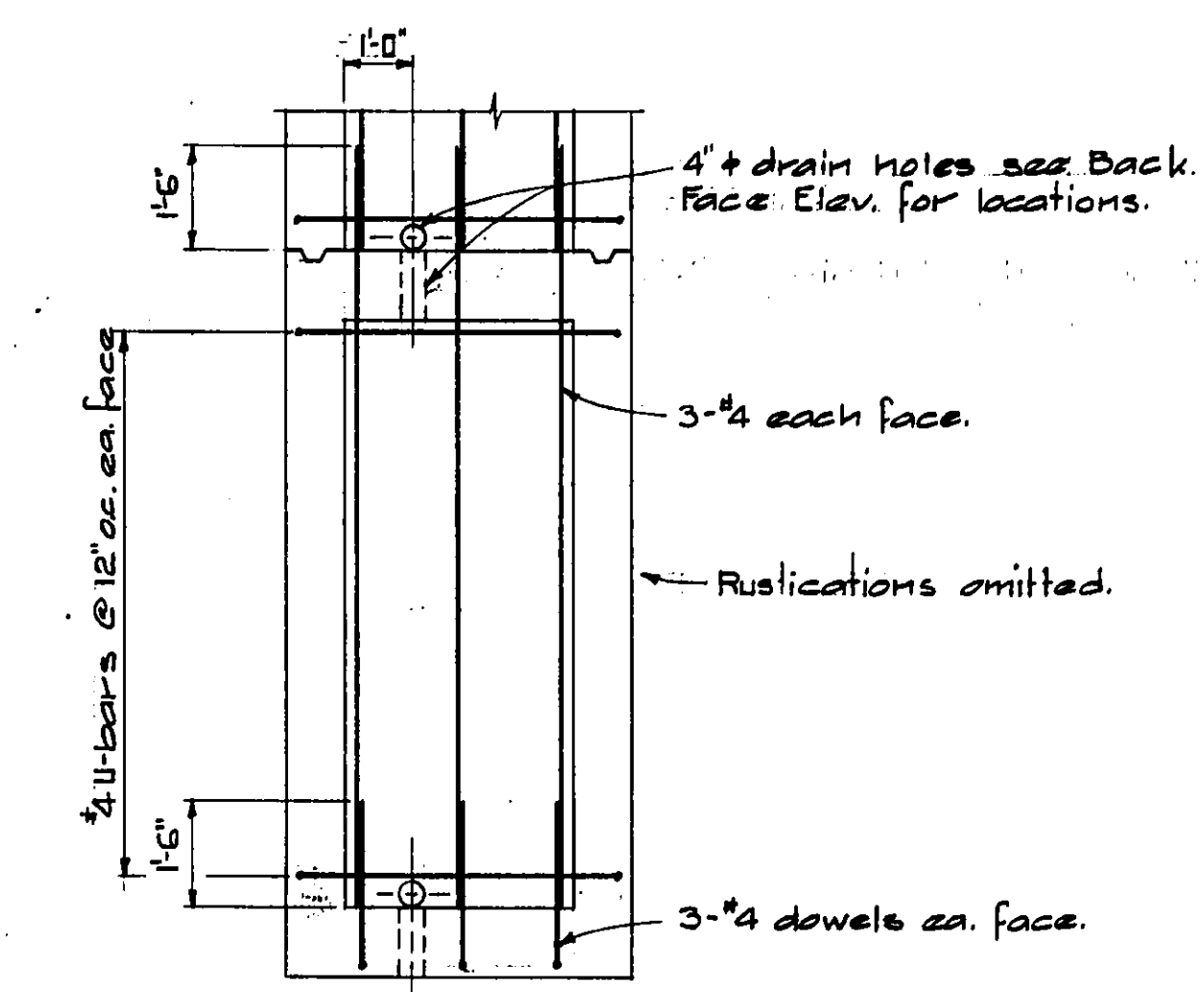
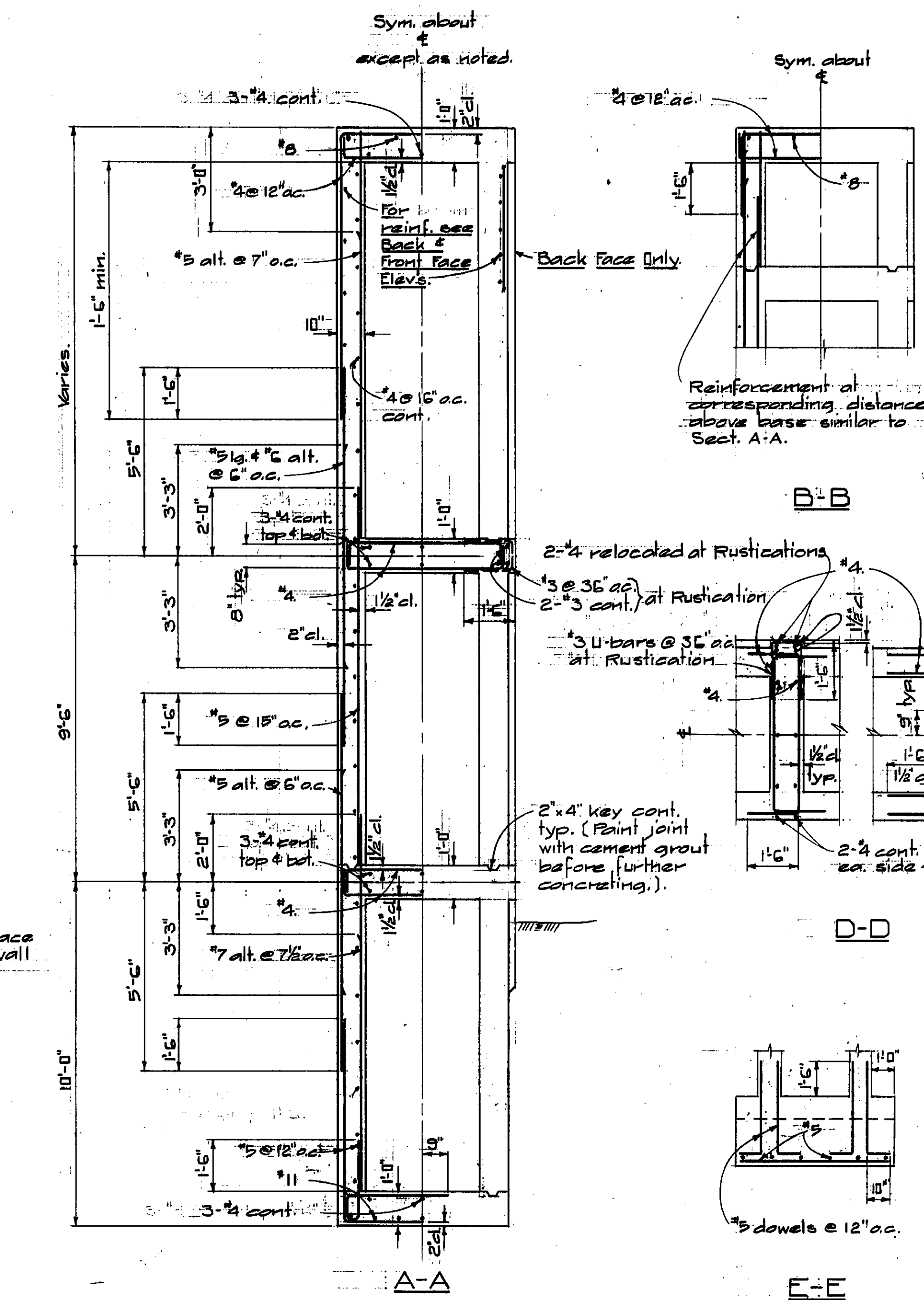
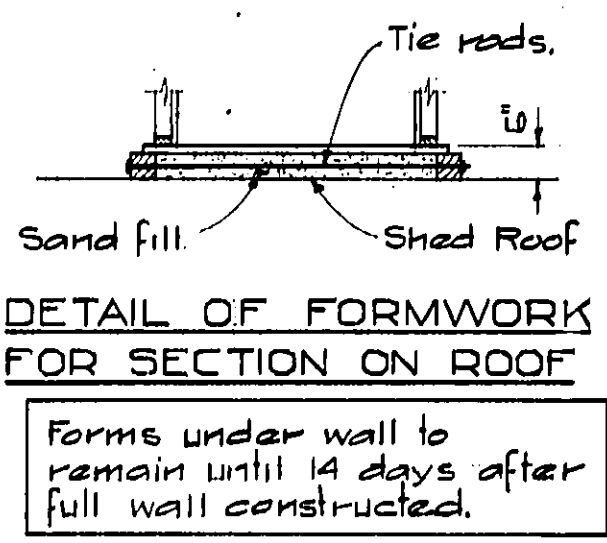
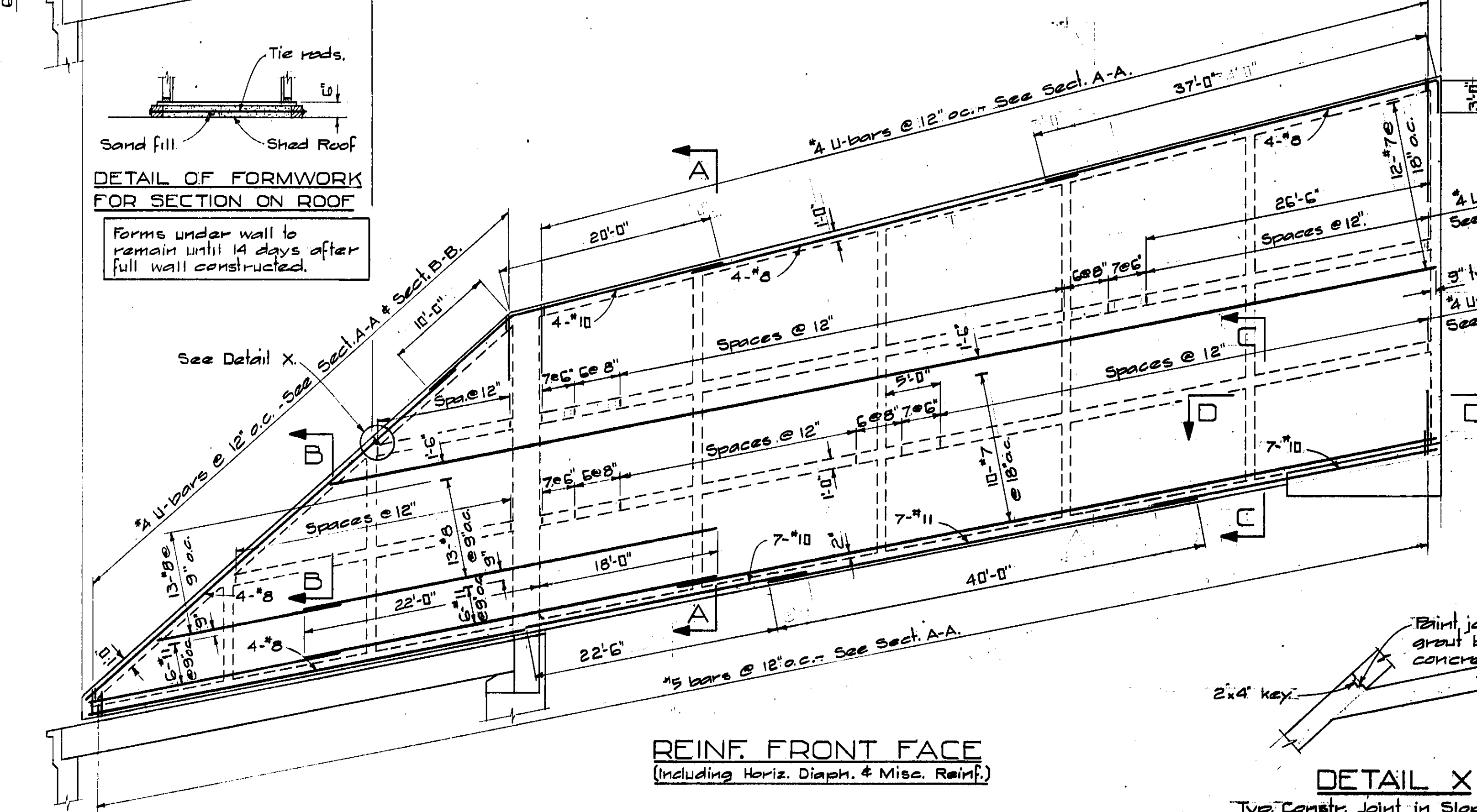
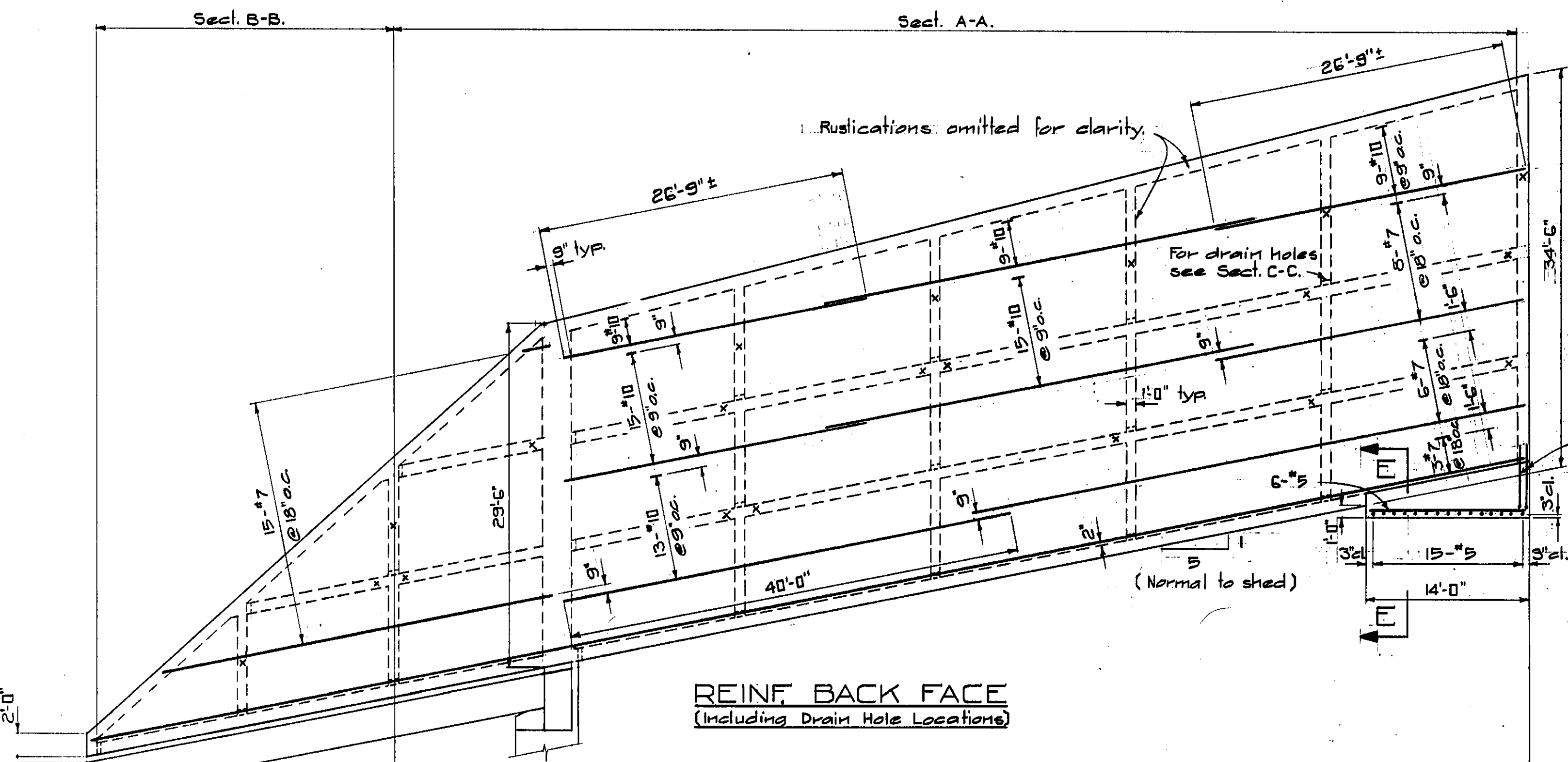
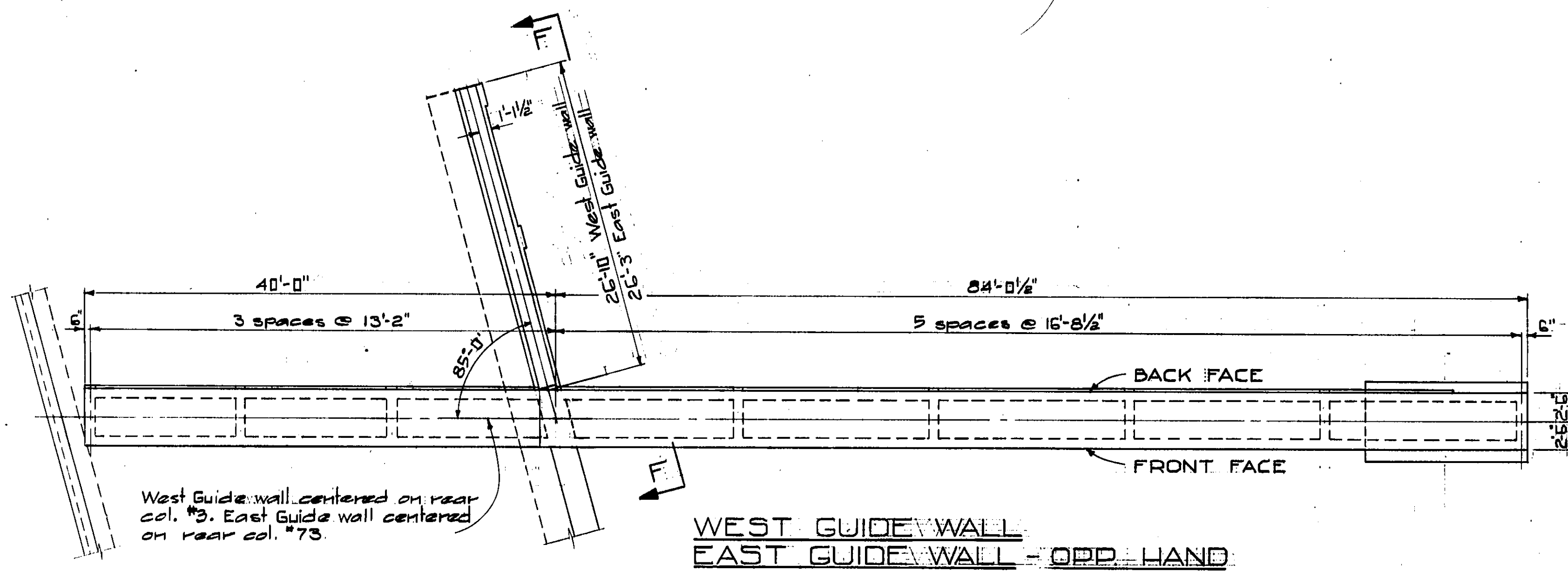

TYP. ACCESS HOLES IN DIAPHS.
(Access hole locations shall be approved by the Engineer.)

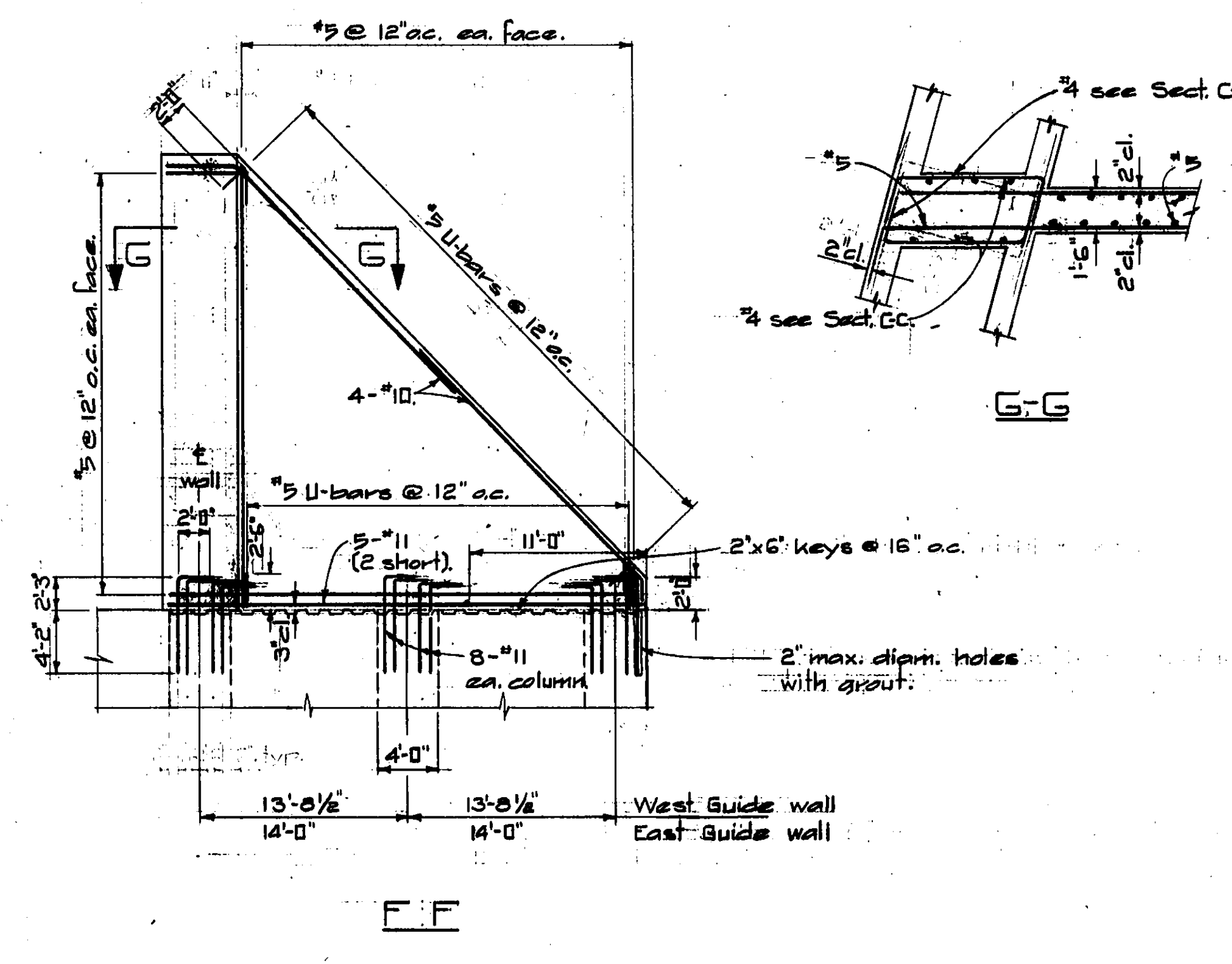
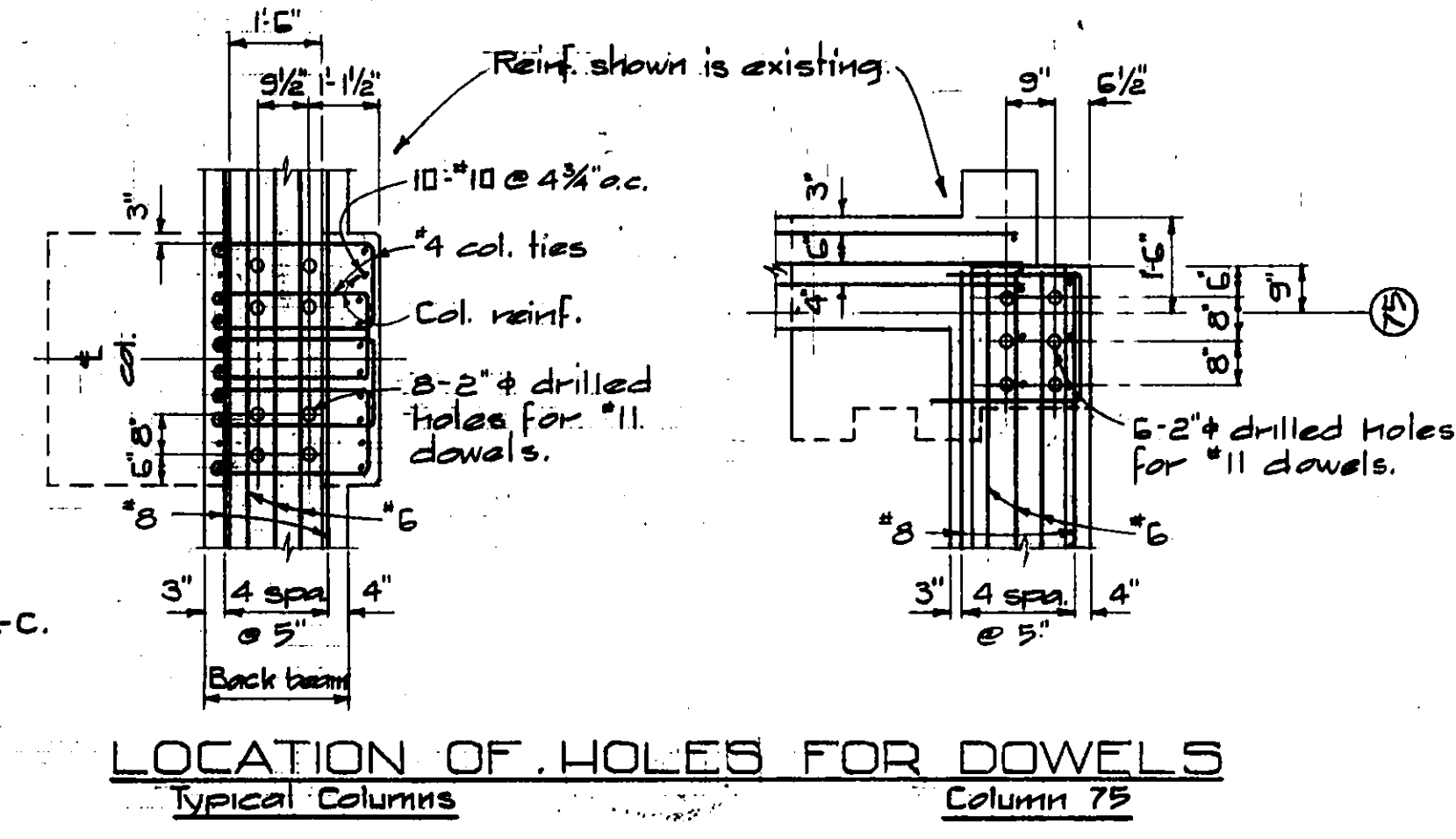

NOTES

For general notes see Dwg. 1696-22.

All reinf. laps shall be 36 diam. (1'-6" min.)

NO.	DATE	REVISION
1	Sept 64	As built

GOV'T. OF THE PROV. OF BRITISH COLUMBIA
DEPT. OF HIGHWAYS

TRANS CANADA HIGHWAY
MILE 505.13
AVALANCHE SHED

AVALANCHE GUIDE WALLS
LANARK SHED



GENERAL ARRANGEMENT APPROVED

CHIEF ENGINEER, DEPT. OF HIGHWAYS

CHOUKALOS, WOODBURN & MCKENZIE LTD.
CONSULTING ENGINEERS
1666 West Broadway, Vancouver 9, B.C.

DRAWN A.I. DATE May 3/63 SCALE 1/8", 3/16", 1/4"
CHECKED V.B. DWG: 1696-23X