

AN EXPERIMENTAL RAINFALL-RUNOFF
FACILITY

by

W. T. Dickinson, M. E. Holland and G. L. Smith

September 1967



HYDROLOGY PAPERS
COLORADO STATE UNIVERSITY
Fort Collins, Colorado

AN EXPERIMENTAL RAINFALL-RUNOFF FACILITY

by

W. T. Dickinson, M. E. Holland and G. L. Smith

HYDROLOGY PAPERS
COLORADO STATE UNIVERSITY
FORT COLLINS, COLORADO

September 1967

No. 25

PREFACE

The Hydrology graduate and research program of the Civil Engineering Department at Colorado State University has several large research projects of a continuing nature. The research areas have been selected in such a way that graduate student theses, special studies by graduate students, research by staff members, either individually or assisted by graduate students, and post-doctoral research work can be carried out.

One of the areas selected for this graduate and research program is small watershed hydrology. It was felt that small watershed hydrology warrants a variety of research efforts since a very small percentage of small watersheds are gaged, and rainfall-runoff relationship and prediction of runoff from rainfall are important subjects.

Of all hydrologic problems related to small watersheds, the problems of floods has been the first singled out for attack. The relationship between rainfall and runoff in floods at small watersheds is the simplest of all relationships. Once this topic had been selected as a long range research project in the graduate and research program in hydrology, the main lines of attack were investigated.

A decision was made that a three-pronged effort should be simultaneously pursued for small watershed floods:

1. To assemble a large amount of hydrologic data from small experimental watersheds and use that data as the basic research material. This line of attack has been applied to floods of small experimental watersheds, and already data on several hundred flood events have been processed, according to a selected methodology, and are stored on magnetic tapes. Research is already underway.
2. To build a research facility for an experimental approach to watershed response to rainfall in floods, and use this facility for several other hydrologic investigations.
3. To pursue analytical research for developing mathematical models of the watershed response under proper working hypotheses, and to properly integrate these three research lines.

To implement this three-pronged research a hydrologic research data unit was established, an experimental approach to hydrologic investigations which are digital computer oriented has been organized and pursued; an extensive study of references on watershed response models has been carried out; and, an experimental facility has been conceived and is under construction. This paper presents various facets in the conception, planning and design of the facilities, and future research activities to be carried out using them. The basic concept of the facility is to take an intermediate position between laboratory scale facilities of rainfall-runoff simulators and the experimental watersheds in nature.

Part I of this paper presents the basic philosophy in conceiving facilities and for the expected future research activities. Several researchers have cooperated in developing these concepts, among them the writer of this preface; Dr. E. M. Laurenson from Australia, while on sabbatical leave at Colorado State University; Dr. Brian M. Reich, associated with this project for two years and now with Pennsylvania State University; Professor W. U. Garstka during the academic year 1966-67; Dr. M. E. Holland, from July 1, 1966 to the present; Professor F. C. Bell from Australia, from July 1, 1966 to June 1967; and several graduate students. Many visitors at the CSU Engineering Research Center have asked pertinent questions which have helped in finalizing various aspects of these facilities. Dr. M. E. Holland has made significant efforts to integrate various concepts with his own contributions and has written Part I of this report.

Mr. G. L. Smith has been associated with this facility from its initiation, and has been involved in the planning, design and supervision of construction. The Electronics Laboratory of the CSU Engineering Research Center has conceived various instruments and a data acquisition system. These results are presented in Part II by G. L. Smith.

Dr. W. T. Dickinson, during his studies for a Ph. D. degree at CSU, abstracted 187 references concerning the theory and various aspects of river basin response to rainfall. As a special study, he has made an appraisal of the state of knowledge on this subject. Two appraisals, the one by Dr. Dickinson and the other by Dr. Holland, are given in Part III. Mr. Y. Erikawa, a graduate student from Japan, has abstracted eight references of Japanese authors, which are included in the bibliography. These 226 references are presented as a bibliography. Dr. Holland has compiled an index by authors and an index by subjects.

The references in the bibliography do not include all works published in English-speaking countries but only those readily accessible to writers. Some references are included from other countries, namely France and Japan. Comparatively few references are included from U. S. S. R., Italy, Germany, and other countries. Therefore, the bibliography is only a partial coverage of the world literature on river basin response. It is hoped that, in the future, this bibliography can be supplemented by a more systematic and exhaustive coverage.

Experimental facilities for rainfall-runoff simulation represent basically an education tool at Colorado State University for training M.S. and Ph. D. candidates in hydrology. It is also intended to use the facility extensively for various other research activities, primarily by the Engineering Research Center staff members. Cooperation with other agencies has also been planned. It is expected that the Agricultural Research Service will take an active part in this cooperation under their current research objectives on small watershed hydrology. These facilities are also available to other researchers in the field of small watershed hydrology.

August 18, 1967
Fort Collins, Colorado

Vujica Yevjevich
Professor-in-Charge of the Hydrology Program
Civil Engineering Department
Colorado State University

ACKNOWLEDGMENTS

The authors wish to acknowledge the guidance of Dr. Vujica Yevjevich, Professor-in-Charge of the Hydrology Program, who conceived and initiated the project for the experimental facility. The Office of Water Resources, United States Department of the Interior has supported the development of the facility under Grant No. 14-01-0001-1007 with matching support from the Colorado Agricultural Experiment Station.

Mr. Yoshikazu Erikawa, graduate student in the Hydrology Program, provided eight abstracts from Japanese literature on the rainfall-runoff relationship.

TABLE OF CONTENTS

	Page
Abstract	
Part I PHILOSOPHY OF APPROACH AND OBJECTIVES	1
I Introduction	1
1. Watershed response	1
2. Studies of watershed response	2
3. Rainfall-runoff experimental facility	3
II Research Applications to Rainfall-Runoff Relations	4
1. Overall objectives	4
2. Model evaluation	4
3. Basic research	5
4. Data required for establishing rainfall-runoff relations	6
III Research Applications to Erosion and Travel of Pollutants	8
1. Concurrent performance of experiments	8
2. Erosion studies	8
3. Travel of pollutants	9
IV Requirements for Rainfall-Runoff Experimental Facility.	10
1. Objectives and general requirements	10
2. Control of rainfall	10
3. Measurement of variables	11
4. Controlled parameter variations	11
V Conclusions	12
Bibliography	13
Part II DESCRIPTION OF EXPERIMENTAL FACILITY	15
1. Introduction	15
2. Facility location	15
3. Facility geometry	15
4. Facility design and construction	18
5. Experimental program	22
Bibliography	24
Part III SURVEY OF WATERSHED RESPONSE MODELS	25
I A Historical Review	25
1. Time distribution of runoff	25
2. Analysis of direct surface runoff	26
3. Analysis of total response	34
II Review of Recent Methods of Determining Watershed Response	36
III A Critical Appraisal of Watershed Response Models	38
1. Accomplishments	38
2. Suggestions for research	38
IV A Discussion of Watershed Response	40
V Annotated Bibliography of Parametric Hydrology	41
Index by authors	79
Index by subjects	81

LIST OF FIGURES AND TABLES

PART I

Figure		Page
1	Fields of fluid mechanics acting in the response of watersheds to rainfall	1
2	Interactions among rainfall-runoff relations, erosion and travel of chemicals in determining the quantity and quality of basin outflow	2
Table 1	Catchment Characteristics During Floods	6

PART II

Figure		
RR1	Base map of rainfall-runoff facility	16
RR2	Water supply and drainage system	17
RR3	Pumping plant	18
RR4	Map of developed facility area	19
RR5	Pictorial view of facility area	20
RR6	Block diagram of capacitance gage analog rain system	20
RR7	Precipitation measuring system	21
RR8	Data acquisition system	22
RR9	Runoff measuring flumes	23
RR10	Preliminary rainfall towers	24

PART III

Figure 1	Hydrographs illustrating methods of baseflow separation	26
Table 1	Location and area of watersheds studied by various researchers . .	28
2	Hydrograph, watershed, and storm parameters considered in watershed response literature	29, 30, 31
3	Dimensionless unit hydrographs	32

ABSTRACT

Part I. An experimental facility is described for the investigation of the rainfall-runoff relationship. Large enough to respond as a prototype watershed, but small enough to permit controlled variation of watershed characteristics and artificial application of rainfall. The criteria for the facility are related to (1) control of rainfall, which should be reproducible and reasonably uniform, (2) measurement of variables, with attention to variations in time and space, and (3) variation of watershed parameters.

The experimental facility has potential application in studies of rainfall-runoff response, erosion, and travel of pollutants on watersheds. It serves to contract time and space in generating runoff events and is applicable to studies of individual runoff processes and to evaluation of mathematical and physical models of watershed response.

Part II. The design and construction of the rainfall-runoff experimental facility is described. Three phases are discussed: (1) site selection, (2) selection of basic geometry of facility, and (3) design and construction techniques of site preparation, methods of precipitation and discharge measurement with automatic digital recording of data, soil surface treatment, and proposed precipitation towers.

Part III. A review and appraisal of the status of mathematical models of hydrologic watershed response is followed by an annotated bibliography of 226 references relating studies of watershed response.

AN EXPERIMENTAL RAINFALL-RUNOFF FACILITY

by W. T. Dickinson, M. E. Holland and G. L. Smith

PART I. PHILOSOPHY OF APPROACH AND OBJECTIVES

by M. E. Holland*

CHAPTER I

INTRODUCTION

1. Watershed Response

The runoff process. The response of a watershed to precipitation is the most significant relationship in hydrology. All the water in lakes and streams and nearly all the ground water entered the field of interest of hydrologists as precipitation on a watershed. The processes that act on precipitation to generate the runoff phenomenon are complex and involve many areas of fluid mechanics.

Consider, for example, the idealized description of runoff generation represented schematically in fig. 1.

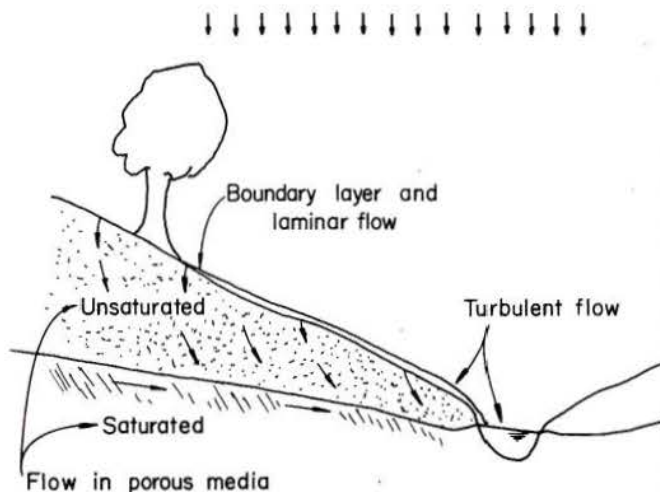

Fig. 1 Fields of fluid mechanics acting in the response of watersheds to rainfall.

The first portion of rainfall wets the surfaces of soil and vegetation. Next, a thin film of water is built up on the ground surface. This part of the rainfall is termed interception and depression storage.

As the surface film of water gets deeper, the water begins to flow in accordance with boundary layer fluid mechanics. At first the flow is laminar, but as the quantity and speed of flow increase the flow becomes increasingly turbulent. When the overland flow reaches a runoff channel, it enters the region where turbulent flow is fully established and the techniques of open channel hydraulics are applicable.

Not all the rainfall moves to the stream by overland flow. Part is lost by evaporation and part infiltrates into the soil. The movement into the soil involves a three-phase air-water-soil interface. The movement of water under ground is governed by the laws of flow in porous media. One portion percolates directly to the ground water, but part moves to the stream without reaching the water table.

The response of stream runoff to precipitation is a result of interactions among these processes in which the effects of one process gradually shade into the effects of another. The complexity of the rainfall-runoff relationship is increased by the areal variation of geologic formations, soil conditions and vegetation, and by the areal and time variations of meteorological conditions. The movement of water into and under the ground is determined by soil conditions and geologic formations, while meteorological conditions affect precipitation and evaporation. Vegetation influences the rainfall-runoff relationship not only through interception and surface detention, but also by its effect on the impact energy of rainfall, which may initiate turbulence in overland flow and increase erosion.

In view of the complexity and interdependence of the processes that convert precipitation into stream flow, it is not surprising that the rainfall-runoff relationship has not yet been related satisfactorily to watershed parameters.

An additional complexity enters the rainfall-runoff relation when the precipitation is in the form of snow. There is, in this case, a storage of the precipitation on the ground. The snowmelt process is sufficiently complicated itself that it will be omitted from the following discussions. This is consistent with most investigations of the rainfall-runoff relation.

Erosion and water quality. The description above indicates some of the processes affecting the quantity of water flowing in a stream, but this is not all that is of interest. When rainfall strikes the ground surface or when surface runoff from rain or snowmelt moves over the surface, soil particles are dislodged and moved. As the energy in the water increases, the amount of erosion increases, and the turbulent flow in the stream channel has a great capacity to erode and transport material. Erosion is especially significant in the arid regions where there is less vegetation to shield the ground from the impact of raindrops and where rainfall frequently occurs in short-duration, high-intensity patterns with rapid runoff from the relatively bare soil.

* Assistant Professor, Civil Engineering Department, Colorado State University, Fort Collins, Colorado.

Sediment carried by rivers is deposited in reservoirs, decreasing their storage capacity, or must be removed from water diverted for irrigation or other water supply purposes. Thus, it is important to investigate erosion processes to improve both the prediction of sediment yield and the means of controlling erosion. In addition, there is a strong interdependence between the rainfall-runoff response of a stream and the erosion process. Erosion develops as a result of the water flow, but the pattern of erosion influences the subsequent flow conditions. The stream net itself is generated through the erosion process.

Related to the erosion process is the chemical quality of the stream water. Erosion makes available more material for dissolution, and the weathering associated with the dissolution makes the soil more easily eroded. But the quality of waters in streams is not determined completely by natural processes. Much of the dissolved material in streams results from man's activities. Plowing fields, making cuts and fills for roads, and similar actions make available more material for erosion and dissolution, and the use of chemicals for fertilizers, insecticides, pesticides and herbicides has increased the pollution of streams. Little is known of the travel and fate of chemicals in the watershed response to rainfall, but it is clear that significant amounts do show up in the streams.

Summary on watershed response. The response of a watershed to precipitation is a complex interaction among processes affecting the quantity of flow, erosion and travel of chemical constituents. Figure 2 indicates a simplified view of the interactions that develop the quantity and quality of the surface and subsurface outflow from a watershed.

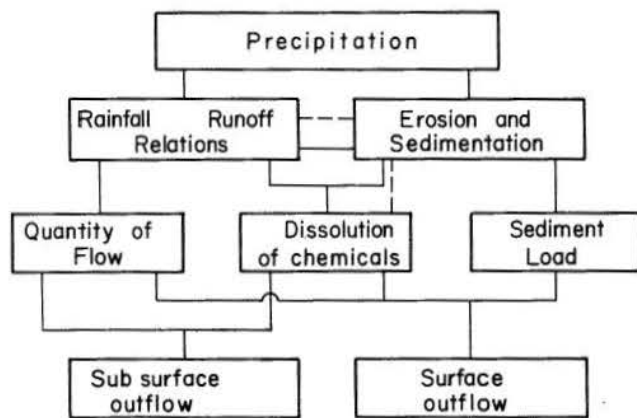

Fig. 2 Interactions among rainfall-runoff relations, erosion and travel of chemicals in determining the quantity and quality of basin outflow.

Precipitation has a direct effect on erosion and also is the input to the rainfall-runoff relation. The runoff relation determines the quantities of flow in the various surface and subsurface processes resulting from the given precipitation. The surface flow affects the erosion process and the dissolution of chemicals. The erosion process provides material for the dissolved load and for the sediment load of the stream, and these two combined with the flow quantities establish the stream response. The effects of chemical dissolution on erosion and of erosion on the rainfall-runoff relation are usually long-term effects and are indicated by dashed lines.

2. Studies of Watershed Response

Much more work has been done on the rainfall-runoff process than on erosion or travel of pollutants. The remainder of this chapter will deal explicitly with the runoff process, but many of the comments may be applied to studies of the other two.

Two approaches have been used in the attempt to establish rainfall-runoff relationships. One approach is the use of small laboratory-scale physical models either to study one of the component processes, such as overland flow, or to develop a response dynamically similar to a natural watershed. The other approach uses data from natural rainfall-runoff events on many watersheds or on an experimental watershed having extensive measurements of variables. The experimental watershed relies on the natural distributions of geologic and meteorologic conditions, but permits manipulation of surface conditions. Some of the factors operating in these two approaches are discussed below before the intermediate approach proposed in this paper is presented.

Physical models. The use of laboratory models is frequent in the study of hydraulics, but is less common in hydrologic investigations. Amorcho and Orlob [3] investigated the overland flow process by using a rectangular plane surface covered with a coarse gravel to study the nonlinearity of the response of a system qualitatively similar to the watershed model. They point out that if the scale of particles were reduced to achieve a similarity model, a fine sand would be necessary and the capillary retention in the model would be far more significant than in the prototype watershed. Instead of being a scale model, their system provided some detention and an inter-related pattern of flow paths which has a general similarity to the flow patterns in a watershed. Chow [8] is using model studies to delve into the nature of idealized overland flow combined with channel flow. Here again the purpose is to study the mechanics of a particular process rather than to model a watershed. Strict control of the rainfall over a surface that can have a size as large as 40 x 40 feet is combined with accurate observation of rainfall and runoff to study the runoff process characteristics.

Chery [7] and Grace and Eagleson [12] have examined the requirements of scale models for dynamic similarity and applied the scale model approach to simple runoff systems. Dimensionless parameters may be established by dimensional analysis to guide the scaling of the model parameters, but since it is impossible to satisfy all of the scaling requirements simultaneously, a selection must be made of the more important factors. The present knowledge of the response of a watershed makes the selection difficult. In both of the studies referred to above, the surface tension effect was omitted from the similarity model. The results indicated that surface tension plays a significant role in causing disagreement between model and prototype responses. Chery [7] describes how the water was retained on the surface until a sufficiently large globule was formed and flowed down the surface as a slug. Thus, it is clear that the choice of the appropriate scaling parameters for dynamic similarity needs more investigation.

The use of physical models both for studying component processes and for modeling dynamic response of natural watersheds has had relatively little application to date. It has not been possible to transfer the results of the studies of physical models

to natural watersheds. Not only are the modeling characteristics uncertain, but also the conditions of natural watersheds are so varied that it would be difficult to demonstrate the validity of a model if dynamic similarity of response processes were achieved. The distribution of natural rainfall and initial watershed conditions are rarely as uniform as in the model and are usually not well known.

Natural rainfall-runoff events. Rainfall-runoff events on natural watersheds have been the most common source of data for studying the watershed response. The need for extensive measurements to evaluate the complex processes led to the development of experimental watersheds. The experimental watersheds are small catchments with rather extensive measurements of rainfall and basin conditions and perhaps some control over the modification of the watershed characteristics by man. They are not models, but natural watersheds with basin conditions that may be distributed in a complex manner over the watershed area and are changing in time as the watershed geomorphology evolves. A large amount of data has been collected for natural rainfall-runoff events, but the watershed and meteorological conditions are so variable that analysis has been difficult. Long records are required to accumulate a number of events sufficient to permit statistically significant conclusions. There is a need for the data from many of the experimental watersheds to be compiled and analyzed. A program to assemble such data on magnetic tape for convenient access by computer is now in progress at Colorado State University [16]. The information contained in the records of natural events has not been utilized to the extent that modern computers and statistical methods permit. However, the conclusions that are obtainable from analysis of natural rainfall-runoff events are limited by the uncontrolled variations of watershed parameters and the lack of availability of reliable temporal and spatial distributions of rainfall.

3. Rainfall-Runoff Experimental Facility

The results of studies of watershed response by laboratory models cannot, at present, be transferred directly to natural watersheds, while the studies utilizing the natural events are hampered by the complexity of the uncontrolled conditions. The approach recommended herein is an intermediate facility between the laboratory model and the experimental watershed. It would be large enough to respond on the same scale as a real watershed, but small enough so that the basin parameters could be modified in a controlled manner and rainfall could be applied artificially. This would make possible a contraction of space and time in generating rainfall-runoff events. The modification of basin parameters permits the use of one watershed to examine effects that would require several experimental watersheds for equivalent discrimination among parameter effects. The artificial application of rainfall facilitates the generation of many runoff events in a span of time in which a single event might occur in nature. A series of events with return periods of several years in nature could be repeated in a few days. This would not be a model of a watershed, but a prototype catchment with simplified conditions. The runoff system could begin with simple geometry and an impermeable surface to study the influences of basin shape, slope and drainage pattern. More complicated geometry and more complex processes, such as infiltration, could be brought into play when there is sufficient understanding of the simpler system to permit evaluation and separation of the effects of the more complex processes.

Three general areas -- rainfall-runoff relations, erosion, and travel of pollutants -- were mentioned above in the response of a watershed. The usefulness of the rainfall-runoff experimental facility in studying processes under these headings will be considered in the next two chapters. The objectives and requirements of the facility in such research programs are discussed in Chapter 4.

CHAPTER II

RESEARCH APPLICATIONS TO RAINFALL-RUNOFF RELATIONS

1. Overall Objectives

The rainfall-runoff experimental facility provides a tool for observing prototype-scale response of a watershed under controlled conditions. The general objectives are to increase the understanding of processes making up watershed response and to improve our ability to apply knowledge of the processes to the estimation of the response of real watersheds.

In fulfilling these objectives, two types of studies may be used. One application of the rainfall-runoff experimental facility is in the evaluation and improvement of models of hydrologic response. Although several mathematical models and a few physical models have been established to generate the response of a catchment to rainfall, the comparisons with natural runoff events for observed rainfall have not been consistently favorable. The variability of natural conditions makes it difficult to decide whether the cause of the discrepancies lies in the model prediction or the inaccuracies of the estimates of input and state variables.

The second type of study involves the controlled variation of watershed parameters to generate information about the roles of the various processes in runoff generation. An additional objective of the initial studies with the experimental facility is the investigation of the range of applicability of the approach intermediate between the bench scale model and the experimental watershed.

The experimental facility should not be used where other techniques, such as computer model studies, are more efficient, and the delineation of areas of better applicability for the facility is a significant objective in the early stages of experimentation.

Some topics of research in which the rainfall-runoff experimental facility may be applied in the study of the rainfall-runoff relationship are considered in the remainder of this chapter. Applications in the studies of erosion and travel of pollution are discussed in the next chapter and Chapter IV includes the discussion of the requirements that the objectives described above and the potential research applications set for the experimental facility.

2. Model Evaluation

Models may be divided into three classes -- iconic (look-alike), analog and symbolic -- and all three are used in hydrology. The physical models mentioned in the previous chapter are iconic models, while the unit hydrograph and other mathematical relations are symbolic models. For the discussion of applications of the rainfall-runoff facility, the analog and symbolic models may be considered together, since they both involve a conceptual abstraction of the physical processes of the watershed. The analog model is a tool for solution of the equations defining the response. Analog models are omitted from the discussion below, but could be considered in a manner similar to that for the mathematical models.

Mathematical models. The methods of hydrologic investigation have been reviewed by Amorocho and Hart [2]. The symbolic models included here are in the area of parametric hydrology as opposed to stochastic hydrology. The latter utilizes the statistical properties of historical records of hydrologic events and is not concerned with the deterministic behavior of the rainfall-runoff processes. Since the rainfall-runoff experimental facility is intended primarily to investigate the nature of the processes, stochastic models may be deleted from the discussion. The formulations that have been used in the attempt to predict runoff rates and volumes have ranged from empirical formulas and regional frequency relations to complex models synthesizing the runoff from the component processes acting on rainfall. Some of the general types of symbolic models are briefly described below, and a summary and bibliography of parametric hydrology is presented in Part III of this paper.

Unit hydrograph. The unit hydrograph is one of the most widely used models of runoff response and the synthetic unit hydrograph is the extension to ungauged watersheds. Various approaches have been used to relate the parameters of the unit hydrograph to measurable watershed parameters. Gray [14] and Reich [22], for example, present different methods for determining the model parameters.

Routing models. The unit hydrograph is a special case of the method of routing runoff through channel and storage elements. The unit hydrograph corresponds to the case of linear elements in the routing procedure. Routing methods are basically techniques for solving the differential (or difference) equations of flow through channels and storage. Laurenson [15] has discussed the requirements of input and storage, or runoff routing, models and presented a nonlinear model that breaks the watershed into many small segments for approximate solution of the flow relations. Wooding [25] has considered the differential equations of flow for an idealized model of the watershed divided into an overland flow segment and a channel flow segment and approached the solution by the method of characteristics. Finally, Machmeier [18] has presented a routing model in which the watershed stream response is broken into a large number of small stream networks which are then combined to give the total response.

Synthesis models. An alternative method of generating the watershed response by routing elements of the system utilizes component processes of the runoff cycle instead of sub-areas of the basin. Crawford and Linsley [9, 10] and Boughton [5] have developed models of this type. The rainfall is divided among the various processes and each portion is routed according to a model of the component process. Bell [4] has examined some of these models in the light of present knowledge of component processes.

Experimental testing of models. The symbolic models described above and other mathematical

models are tested by their ability to reproduce known hydrographs when the appropriate rainfall is fed into them. The use of data from natural catchments limits the testing because there are few basins with the required data available. Thus, the range of variability of most of the factors affecting the hydrograph is limited. In addition, the symbolic model usually makes significant simplifying assumptions that may be only partially satisfied in nature. This means that conditions assumed in the model, such as uniform rainfall, may not have been true for the event generating the data with which the model is being compared.

The use of the rainfall-runoff experimental facility would permit a large number of runoff events with known parametric variations to be utilized in testing the hypothesized rainfall-runoff relationships. The ability to modify the parameters makes it possible to use the test results to improve, as well as evaluate, the models.

Physical models. The use of physical models was mentioned in the first chapter, where it was pointed out that it is not possible at present to transfer results directly from models to natural watersheds. Grace and Eagleson [13] indicate the need for prototype basins having extensive rainfall-runoff records for comparison with model results. The rainfall-runoff experimental facility provides the means of generating a number of such basin records within a relatively short time. The control of rainfall and watershed conditions also makes available conditions that are more nearly like the idealized laboratory model conditions. The experimental facility is not a model and conditions will not be as completely controlled as they are for laboratory models, but it is an ideal prototype for comparison with model response.

The control over watershed conditions makes it possible to consider the ranges of variation of parameter values within which the modeling laws are valid. The ability to establish simple geometry with idealized conditions offers a minimum of interactions to confound the interpretation of model vs. prototype response. The use of simple systems also suggests the potential application of the experimental facility to extending physical models of component processes to include moderate interactions. This will help in the transfer of results to natural watersheds.

3. Basic Research

Application of rainfall-runoff experimental facility. The basic processes of the runoff response can be examined with the experimental facility because a large number of simulated storms with a wide variety of characteristics can be generated quickly under controlled conditions. The time distribution of rainfall and the areal distribution of rainfall and watershed parameters will be determined more completely than in natural catchments. An individual factor may be tested by a series of runs with the single parameter value varied while all others remain constant. If some of the data appear to be in error, a storm sequence can be repeated to confirm or correct the values. This flexibility can increase the reliability of individual records because in natural runoff events the conditions are never the same for two events and discrepancies cannot be checked by repetition. The ability to modify individual parameter values makes it possible to examine more closely a factor that is believed to have a significant effect on the runoff response. For example, in small watersheds the

overland flow system is very important in determining the shape of the outflow hydrograph. The slopes of overland flow areas can be varied while stream configurations, channel slopes and catchment surface conditions remain fixed. The effects of the slope on outflow may then more easily be determined.

Parameter variations. Only the more important parameters could be examined by the technique of varying one parameter at a time in a series of experiments because the number of factors is so large that varying each one individually is impractical. The following discussion illustrates the wide variety of conditions that may be established with the rainfall-runoff experimental facility and indicates the necessity for efficient design of experiments to permit statistically valid interpretations to be made from a series of experiments that does not include all possible combinations of parameter values. Laurenson et al. [16] gave the parameters listed in Table 1 for catchment characteristics that should be determined for natural flood events. Many of the parameters listed in the table repeat information, such as four measures of average stream slope and six measures of overland slope. But many of the parameters can be varied independently for the rainfall-runoff experimental facility. The slopes of the stream channels and of the overland flow surfaces can be varied to give many different combinations. The slopes may be made uniform in the upstream direction or given some concavity as is generally observed in natural catchments. The general shape of the catchment and the stream configuration do not vary independently. Instead, there is effectively a conditional distribution of likely stream configurations for each basin shape.

For any set of topographic features, there are significant factors that can be varied. By creating artificial surface detention by means of depressions or barriers to flow, the nature of surface storage may be examined. The surface of the basins may be impervious or pervious and there can be spatial variations in the surface permeability. For a basin with a permeable surface, the subsurface flow could be allowed to enter the stream channel or could be diverted before it reaches the stream. This could contribute to a study of the effects and nature of interflow. The stream channel sides and bottom could be permeable or impermeable to permit investigation of the interactions between the channel flow and bank storage and/or ground water conditions.

Sampling parameter values. If only a limited set of variables is selected to represent the shape, slope and surface parameters, the need for considering statistical criteria in the selection of parameter values will be clear. Let the length and width parameters, L and W , represent the basin shape and the drainage density, D , measure the stream configuration. Taking the channel storage, K , the stream slope, S , the overland slope, R , and the infiltration capacity, f_s , as being significant to runoff hydrograph generation, there appear seven (7) parameters in a relatively simple runoff system. If each parameter were assigned three potential values the number of permutations of values would be $(3)^7$, or nearly 2200 experiments that would be required to run all permutations. This would not include changes in the area of the catchment, which might be varied in conjunction with the length and width, or time and areal distributions of rainfall and surface conditions. It is evident that the selection of watershed and rainfall parameter values must include sampling in many dimensions. The use of individually varied parameters could then be utilized to examine in more detail

TABLE 1
CATCHMENT CHARACTERISTICS DURING FLOODS

A. <u>Constant from flood to flood</u>		
Area	A	
Channel Storage	K	from $Q_t = Q_o K^t$
Drainage Density	D_d	
Shape:		
Length	L	
Width	W	= A/L
Form Factor	F	= W/L
Compactness Coefficient	C	= $0.28 P/A^{1/2}$
Length to Centroid	L_c	Centroid of area
	L_m	Characteristics of shape-
	S_d	area curve
Stream Slope	S_1	
	S_2	Alternative slope measures.
	S_3	See original paper for definition
	S_4	
Overland Slope	R_1	
	R_2	
	R_3	
	R_4	Same as above
	R_5	
	R_6	
B. <u>Vary from flood to flood</u>		
Antecedent Wetness	P_a	= $\sum_{i=1}^{30} p_i 0.85^{t_i}$
	Q_i	low flow in stream
Standard Infiltration Capacity	f_s	
Interception Capacity	I	
Initial Loss	L_i	
Loss Rate	ϕ	

the factors which seem to be most significant or to provide additional data to discriminate among effects of factors where the sampling in many dimensions gives inconclusive results. It is to be expected that the effects of some factors that may be related, such as catchment shape and stream configuration, may not be sufficiently distinguished. If the joint effects are important, it will be appropriate to run a detailed series of experiments. However, if the combined effects of the factors are not significant, it is not necessary to discriminate among the individual effects.

A detailed analysis of the design of experiments is not appropriate to this report, but the above discussion indicates that the potential variations in parameter values are too numerous to be examined by the exhaustive approach, that is, by testing all possible permutations of values. Instead, a sample of, say, 50 of the 2200 permutations will be used to infer the effects of the parameters. Additional experiments can then be designed on the basis of the results of the initial evaluations. The required number of

experiments can be further reduced by recognizing the geomorphological interactions that cause some parameters to be related.

The final results of watershed response studies will be compared to data from natural watersheds, so it is appropriate to use historical data to establish some of the ranges and interrelations for the parameter values to be used in the experimental runs. Initial experimental results may suggest major factors or groups of factors that should be examined in greater detail while all other parameters are held constant.

4. Data Required for Establishing Rainfall-Runoff Relations

The data that are needed for the study of the processes in the runoff system are essentially the same for all the applications described above. The distribution of rainfall in time at several points in the basin, a runoff hydrograph at the point of outflow

from the basin, a topographic map of the catchment and maps indicating surface and soil conditions such as roughness and permeability comprise the basic data requirements. The rainfall mass-curves (time distributions) permit the determination of the joint time-space distribution of rainfall intensities. In addition to the surface runoff hydrograph, it would be necessary to determine any subsurface outflow that might occur and it might be appropriate to obtain hydrographs of outflow from subareas within the basin, for example, to separate the effects due to streamflow routing. From the topographic maps, the watershed shape, stream configuration, slopes and other physio-

graphic parameters may be established. Surface conditions such as roughness and permeability may also be recorded on maps when areal variations are permitted.

Other data that might be appropriate to particular studies include the location of the water table under the catchment surface when permeable soil is used. The interaction of the stream channel with the water table and/or bank storage could be studied if the moisture conditions were measured at appropriate locations.

CHAPTER III

RESEARCH APPLICATIONS TO EROSION AND TRAVEL OF POLLUTANTS

1. Concurrent Performance of Experiments

The topics for research have been divided into three groups -- rainfall-runoff relations, discussed above, erosion and travel of pollutants. The classification is somewhat arbitrary and some experiments may involve subjects under more than one heading. In fact it may be more efficient to plan a set of experiments in which processes in more than one group are combined without interference between processes. For example, the hydraulic response of the system is independent of the concentration of most chemicals and a study of the fate of the chemicals requires knowledge of the quantity of flow per unit of time as well as the concentrations of chemicals at the times of sampling. Making two separate runs would lead to a duplication of data, so the two studies might be more efficiently planned for concurrent operation.

There are, of course, many processes which influence each other to such an extent that the interpretation of results becomes more difficult in concurrent operations. Thus, the use of easily eroded surface material for erosion studies might change the hydraulic response significantly during the course of an experiment.

It should, therefore, be kept in mind that the classifications of research subjects under separate headings does not mean that processes in different groups are necessarily independent or that the rainfall-runoff experimental facility must be limited to topics from a single group during any particular experiment. The conditions under which several topics may be studied through concurrent operations depends on the interaction between the processes and on the availability of equipment and personnel to operate the input-control and data-collection systems.

2. Erosion Studies

Need for research. The need for research into erosion and sedimentation was discussed by Ackermann [1] in a Symposium on Watershed Erosion and Sediment Yields. The sediment yield of a catchment affects the useful life of hydraulic structures such as reservoirs and water diversion canals below the basin. The effects are especially significant in arid areas where sediment yields are frequently quite large. Overestimating sediment yields results in oversized structures with consequent extra cost and underestimating sediment causes a decrease in the planned useful life of the structure or increased maintenance costs to remove the additional sediment. For the many small watersheds that represent a significant part of the future development in water resources, the understanding of the erosion process within the watershed may be the only means of achieving accurate estimates of sediment yields.

There are other reasons for studying erosion than the estimation of sediment yield. The development of stream networks is a result of the erosion

process. The character of a watershed may change little over a short period due to these processes, but there may be considerable interest in the long term developments. In addition to predicting effects in purely natural settings, the estimation of the effects of man-made structures is becoming important. What conditions may future generations expect when the large flood-control dams of the Southwest have become filled with sediment? Such questions are difficult to answer with our current knowledge of the geomorphology of river systems, but they will eventually have to be answered. Thus, the study of the development of stream networks is an appropriate extension of erosion studies.

Use of experimental facility. Many of the same factors that affect the rainfall-runoff relationship also influence the rates of erosion and sedimentation, so the rainfall-runoff facility is applicable to the study of the latter. Since the energy provided by the impacting raindrop is a primary factor in erosion, the drop size distribution and velocity or energy of impact need to be determined [21]. The distributions of various sizes of particles in the soil and sediments of the catchment and in the outflow from the basin must be measured and correlated with the flow characteristics. By using different soils on the watershed, studies of the effects of soil particle size and density may be pursued. The effects of rainfall energy as opposed to overland flow energy in promoting erosion might be studied by providing an input of overland flow in some areas of the basin to change the ratio of surface flow to rainfall. The differences in erosion effects in different areas might suggest conditions under which one or the other process has the dominant influence. The differences in overland flow rates might be established by actually adding inflow sources at the top of parts of the basin or by diverting the flow that develops on the basin to concentrate it in some sections.

Processes of sedimentation and erosion on a macro-scale could be examined with the rainfall-runoff facility. For example, the inception of erosion might be considered as a random process which has a probability density function distributed uniformly over areas with the same soil and rainfall conditions, and observed erosion patterns could be examined for consistency with the hypothesis.

The progress of erosion could also be studied on a macro-scale in the basin. This could be done with the naturally developing erosion patterns or with artificially created initial erosion patterns. The results of such studies could indicate the extent to which mature erosion patterns are controlled by the early developments. For example, many rainstorm events in the early stages of erosion may have sufficient energy to modify the erosion patterns which the geologic processes and wind effects have initiated. The question may then be asked whether the rainstorm patterns or the initial topographic contours of the basin have the greater effect in establishing the later erosion patterns.

Such considerations lead directly to the study of the generation of stream networks. The stream system develops as a long-term effect of the erosion processes that occur in a basin. With relatively easily eroded material forming the basin it would be possible to run a series of experiments, each of which would result in a fully established stream network. By controlling the initial distribution of soil characteristics and the rainfall patterns, it would be possible to examine the effects of some of the processes controlling stream configurations. These experiments could help establish whether river network development should be considered a stochastic or a deterministic process.

This does not exhaust the potential topics in erosion that might be studied with the rainfall-runoff facility but it does demonstrate that such studies should be considered in establishing the requirements for the design of the facility.

3. Travel of Pollutants

Need for research. The increasing use of chemicals for pesticides, insecticides, herbicides and fertilizers has made the fate of chemicals on the surface and in the soil significant for estimating the quantity of pollution that reaches the ground water table or stream. Weibel, et al., [24] found that pesticides applied at the ground may be carried on dust particles into and through the air for considerable distances before returning to the ground in rainfall, so the question of fate of pollutants is not necessarily limited to the area of application of the material. The pollution potential from normal agricultural activities has been discussed by Webb [23], and the effects from a wider range of land uses was considered by Bullard [6]. However, relatively little is known of the natural processes by which chemicals are removed from the soil or the extent to which they are carried, in solution or emulsion, in overland flow or in subsurface flow [17].

The growing concern with stream pollution and the search for alternative methods of disposal of wastes will lead to new methods of waste disposal which may involve many different processes in the hydrologic cycle. The dispersal of gaseous wastes into the air, the land-fill disposal of solid wastes and the disposal of liquid wastes by deep well injection affect the quality of the atmosphere, the watershed surface and the underground aquifers. There will be increasing need for more understanding of the travel and fate of pollutants in the catchment system to predict whether novel waste disposal methods that may be developed are actually reducing pollution or are merely changing the location of the pollution effect and delaying the time at which it becomes apparent. For example, land disposal of wastes frequently is used to prevent stream pollution, but sometimes ground water pollution results and is more widespread and more difficult to abate than the stream pollution.

Experimental facility. The rainfall-runoff experimental facility should be an excellent tool for the study of the fate of pollutants because of its ability to provide controlled rainfall on a soil system with the significant variables controlled and measured. Miner [20] applied this general philosophy to a study

of runoff from cattle feed lots by using agricultural sprinklers for the water input and then channeling the flow to a single outlet for measurement and sampling. The system did not accurately simulate the conditions of a rainstorm, but a qualitative idea of the progress of pollutant concentrations was achieved.

The greater control over the input rainfall and over the runoff conditions provided by the facility designed to study rainfall-runoff events should improve considerably the value of the experimental results in making quantitative interpretations. The input quantities of the pollutants can be controlled either by applying a known concentration in the rainfall or by applying a known quantity to the surface of the basin. With the latter approach the pollution can be given spatial variations. The concentrations of pollutants can be determined by sampling the water at various locations in the basin at several times during the runoff period. The concentration in the outflow from the basin as a function of time can be used with the outflow hydrograph to establish the quantity of pollutant leaving the basin. If infiltration is occurring, subsurface water samples could be taken to compare concentrations in subsurface flow with those in overland flow, and soil samples could be used for determining the amount of pollutant stored or trapped in the soil. The depth of soil above an impermeable boundary is one of the variables that could be controlled. The persistence of a chemical in the soil and in runoff after application of the chemical has been terminated could be studied with the rainfall-runoff facility. The depletion or leaching of a pollutant by later rainfall is important in considerations of purging polluted systems to restore the uncontaminated conditions. If a large dose of pollutant were dumped on a catchment, it might be possible to purge the system by artificially applying rainfall at a low rate over a long period of time to keep concentrations in streamflow or ground water from exceeding the minimum standards, where a natural rainstorm might result in a slug of pollution that would cause considerable damage.

As was pointed out at the start of this chapter, many of the experiments in the study of travel of pollutants can be combined with other experiments without any interference. The taking of water and soil samples is the only additional operation during the experiment. Chemical analyses can generally be run at a later time. It is also possible to combine several studies of pollutants simultaneously, by including several chemicals that do not react with one another, but which may have different patterns of travel within the watershed system. For example, chlorides generally go into solution with little interaction with stable soils, while some organic compounds may be preferentially adsorbed on soil particles. But care must be taken because some organic compounds may release chlorides in decomposing or they may form complexes with chlorides, and the results might then be ambiguous. A compromise must be made between the running of many experiments simultaneously for economic use of the facilities and the need for data on isolated processes for ease and clarity of interpretations. Each situation must be considered individually and then re-evaluated after completion of the experiment to improve future decisions.

CHAPTER IV

REQUIREMENTS FOR RAINFALL-RUNOFF EXPERIMENTAL FACILITY

1. Objectives and General Requirements

Objectives. The objective of the rainfall-runoff experimental facility, as stated in Chapter II, is to provide a tool for observing prototype-scale response of a watershed under controlled conditions. The processes operating in a watershed can be observed under idealized conditions with a minimum of complicating interactions. The effects of adding the interactions may then be studied later.

To the two categories of studies for the runoff facility -- (a) evaluation and modification of models and (b) idealized investigation of individual processes-- has been added a third category or research objective that is appropriate for the early stages of development of the facility. This objective is the determination of the range of applicability of the facility intermediate between a laboratory bench model and an experimental watershed. The research potential is indicated by the topics that are discussed in the preceding two chapters. However, the precise requirements for the facility are not known for all topics. Some requirements that are initially considered very important may turn out to be less significant and might be relaxed. Also, a facility of this size has not been utilized before for controlled rainfall-runoff experiments and there will undoubtedly be many problems that have not been foreseen. The improvements that are required to achieve more highly idealized conditions and the approximations that have to be accepted to progress in the existing project may be as important as the initial experimental results. The confirmation of the general approach as a feasible technique for studying hydrologic processes and the determination of the critical components of the experimental facilities and instrumentation can pave the way for an improved generation of facilities.

Requirements. The requirements that are given below are derived from the concept of a facility large enough to respond in the same manner as a real watershed and to serve as a prototype for comparison with laboratory scale models but small enough to permit control over parameter variations. The size requires this to be an outdoor facility, which makes it more difficult to achieve consistent control of variables and makes the measurement of variables more critical. The requirements of the facility will be presented in terms of the ideal of control that is desired. If the control over variations is relaxed to bring the facility into use, then the instrumentation must be adequate to determine the variations that occur in time and space. The requirements are presented below in three general classes: (1) control of rainfall, (2) measurements of variables and (3) modification of basin characteristics.

2. Control of Rainfall

Uniformity and reproducibility. The controlled application of rainfall is the most important feature of the rainfall-runoff simulator. This is the characteristic that distinguishes the facility from

experimental watersheds. The basic requirements of the artificial rainfall are areal uniformity and reproducibility. The facility should be capable of producing an approximately uniform spatial distribution of rainfall over the basin to minimize the masking of the basin response by rainfall variations. A perfectly uniform distribution will not be achieved, but a close approximation should be possible. Natural rainfall is never completely uniform, but the more nearly uniform the rainfall is over the entire basin, the more easily the effects of the watershed response may be evaluated from the experimental data. Of greater importance than uniformity over the entire basin is the uniformity of rainfall over subsections within the basin. Since rainfall measurements are point measurements, it is important that the measured value be representative of the area around the gage.

The reproducibility of rainfall conditions is more important than uniformity. A repetition of an experiment under identical conditions is frequently useful to confirm results for the observed trial or to fill in measurements that may have been missed when an instrument did not operate properly. It is not necessary that a specified distribution be achieved without a trial-and-error approach, but once the control settings for a given pattern of rainfall have been determined, it should be possible to reproduce the conditions with a high degree of reliability at any later time by making the appropriate control settings. If several trial settings are required each time the pattern is reproduced, the antecedent conditions for separate tests could vary significantly.

Rainfall distributions. In the later phases of research with the rainfall-runoff facility, it may be useful to include variations of rainfall in both time and space. Natural rainstorms are frequently characterized by considerable variation in rainfall patterns during storms and if this type of variation can be achieved, the importance of rainfall patterns may be examined more thoroughly. This would complement the studies that would be made by computer simulation of basin response as more is learned of the natures of the component processes. The variations in rainfall patterns require rather sophisticated control systems as is indicated by the descriptions of control systems for laboratory models given by Chow and Harbaugh [8] and Grace and Eagleson [13].

An additional requirement of the simulated rainfall that would be especially important for erosion studies is that the rainfall be realistic with regard to fall velocity and drop size distribution. The importance of the impact energy of the raindrop in erosion process was described in the previous chapter. This may not be a critical factor for studies on the basin with an impervious surface, but extension of research into many of the topics for which the facility has potential requires that this be given serious consideration in designing the rainfall simulator.

3. Measurement of Variables

General requirements. The distributions of parameters and variables in both space and time are needed to interpret the response of the watershed system. If control of the input and state parameters of the system were perfect, their measurement would be of only minor significance because the values could be determined from the control specifications. Since the control is imperfect and the uniformity of rainfall can only be estimated before the facility is operated, the measurements will be quite important.

The quantities that must be measured can be divided into two groups -- those that must be measured during the experimental run and those that may be determined at any convenient time. The rainfall and runoff are the primary variables that must be determined during the experiment, although for some studies, others such as soil moisture and water level will be added to the list. Chemical concentrations for pollution studies require samples to be taken during the run, but the analysis can be delayed. Watershed topography and surface characteristics usually do not change during an experiment or even for a series of experiments. This type of variable may be observed before and after the run (or runs) to confirm their constancy but their measurements do not make the demands that the other variables do on the measuring system.

Some general requirements should be satisfied by the instruments used to measure variables. The act of measuring a variable should have a negligible effect on the system response. For example, in the runoff measurement, the backwater curve from the instrument should not significantly change the flow regime in the runoff basin. The frequency response of the measurement instruments should be such that any variation in the value of a variable that is large enough to affect the system response is measured by the instrument. Eagleson and Shack [11] discuss the requirements this sets for precipitation and stream-flow measurements. Finally, the instrument readings from all instruments should be transmitted to one location for observation and as much of the data as possible should be recorded automatically. This is needed because the changes in the variables may frequently occur faster than a person can take down values. That is, the human response may be too slow according to the above criterion of frequency response. Also, when the data are recorded automatically, there is less chance of error in recording values. Since most of the data will be analyzed with a computer, direct digital recording should be utilized as much as possible to speed the assembly of the basic data into form for computer input.

Special requirements for rainfall measurement. Rainfall input to the watershed has a continuous areal distribution that must be estimated by discrete (point) measurements. The distribution also varies with time. Thus, the joint space-time distribution is to be estimated. As mentioned above, if the distribution were perfectly uniform, the measurement would be of little importance. However,

one of the first requirements of the rainfall measurement system will be to establish the degree of uniformity that is achieved. It will not be necessary for all raingages to be of the recording type and such a system would be expensive. A number of recording gages are necessary to indicate the time variations of rainfall in various sections of the basin, and these can be supplemented by a larger number of less expensive non-recording gages whose total accumulated rainfalls may be distributed in time according to the measurements of the recording gages. As the uniformity of the rainfall is determined for the operating facility, the number of gages required can be adjusted.

4. Controlled Parameter Variations

The third requirement of the rainfall-runoff experimental facility is the ability to vary the basin parameters in a controlled manner. The shape of the basin and the stream configuration represent large scale parameters that can be varied, and the surface roughness and detention characteristics represent more readily variable parameters. The large scale parameters will be modified by using earth-moving equipment to reshape the basin, so they will be varied less frequently than the other variables.

The ranges of variation that will be given to parameter values and the number of steps made within the ranges will be different for different variables. For some factors, there may be little change in the response for wide variations in parameter value, while for others, small variations of the parameter value cause significant differences in response. An analysis of the runoff events in the file of small watershed floods at Colorado State University [16] and existing knowledge of hydrologic responses will suggest approximate ranges and step sizes which can be adjusted as experience is gained with the rainfall runoff experimental facility.

Not all considerations in parameter variations have been discussed here. For example, a precise definition of drainage boundaries is necessary to prevent flow from one area over-running a boundary and influencing the response of another area that is being studied. This can be applied to boundaries of sub-areas within the basin as well as to the boundary of the entire basin. A sharp-edged boundary, large enough to prevent spill-over could be used at the watershed boundary or around a section of the basin that might be isolated for a particular study.

The major points that should be recognized in scheduling parameter variations are (a) that the research plan should be designed so the more easily varied parameters are modified as much as possible before the major features such as shape and stream network are changed; (b) that the ranges and step sizes of parameter variations should be adjusted as experimental data clarifies the relative significance of various factors; and (c) the processes may be more readily evaluated if they can be physically isolated in the basin.

BIBLIOGRAPHY

1. Ackermann, William C., Needed Research in Sedimentation. Transactions American Geophysical Union, 38:6, 925-927 (Dec. 1957).
2. Amorocho, J. and W. E. Hart, A Critique of Current Methods in Hydrologic Systems Investigation. Transactions American Geophysical Union, 45:2, 307-321 (June 1964).
3. Amorocho, J. and Orlob, G. T., Nonlinear Analysis of Hydrologic Systems. Water Resources Center Contribution No. 40, University of California, Berkeley (Nov. 1961).
4. Bell, F. C., A Survey of Recent Developments in Rainfall-Runoff Estimation. Journal of Institution of Engineers, Australia, March 1966, pp. 37-47.
5. Boughton, W. C., A Mathematical Model for Relating Runoff to Rainfall with Daily Data. Institution of Engineers, Australia, Civil Engineering Transactions, Vol. CE8:1, 83-93 (April 1966).
6. Bullard, W. E., Effects of Land Use on Water Resources. Journal Water Pollution Control Federation, 38:4, 645-659 (April 1966).
7. Chery, D. L., Jr., Design and Tests of a Physical Watershed Model. Journal of Hydrology, 4:224-235 (1966).
8. Chow, V. T. and T. E. Harbaugh, Raindrop Production for Laboratory Watershed Experimentation. Journal of Geophysical Research, 70: No. 24, 6111-6119 (Dec. 15, 1965).
9. Crawford, N. H. and R. K. Linsley, A Conceptual Model of the Hydrologic Cycle. International Association of Scientific Hydrology Publication No. 63, pp. 573-587 (1963).
10. Crawford, N. H. and R. K. Linsley, Digital Simulation in Hydrology: Stanford Watershed Model IV. Technical Report No. 39, Dept. of Civil Engineering, Stanford University (July 1966).
11. Eagleson, P. S. and W. J. Shack, Some Criteria for the Measurement of Rainfall and Runoff. Water Resources Research 2: No. 3, 427-436 (1966).
12. Grace, R. A. and P. S. Eagleson, The Modeling of Overland Flow. Water Resources Research 2: No. 3, 393-403 (1966).
13. Grace, R. A. and P. S. Eagleson, Construction and Use of a Physical Model of the Rainfall-Runoff Process. Hydrodynamics Laboratory Technical Note No. 11, Massachusetts Institute of Technology, Cambridge, Mass. (June 1966).
14. Gray, D. M., Synthetic Unit Hydrographs for Small Watersheds. Proc. ASCE 87:HY 4, 33-54 (1961).
15. Laurenson, E. M., A Catchment Storage Model for Runoff Routing. Journal of Hydrology 2:, 141-163 (1964).
16. Laurenson, E. M., E. F. Schulz and V. Yevjevich, Research Data Assembly for Small Watershed Floods. Engineering Research Center Report CER 63 EML-EFS-VMY 37, Colorado State University, Fort Collins, (Sept. 1963).
17. LeGrande, H. E., Patterns of Contaminated Zones of Water in the Ground. Water Research 1:1, 83-95 (1965).
18. Machmeier, R. E. and C. L. Larson, The Effect of Runoff Supply Rate and Duration on Hydrographs for a Mathematical Watershed Model. ASCE Hydraulics Division Annual Conference, Madison, Wisconsin, August 24-26, (1966).
19. Meyer, D. L., Simulation of Rainfall for Soil Erosion Research. Trans. Amer. Soc. of Agricultural Engineers 8:1, 63-65 (1965).
20. Miner, J. R., et al., Cattle Feedlot Runoff - Its Nature and Variation. Journal of Water Pollution Control Federation, 38:10, 1582-1591, (Oct. 1966).
21. Palmer, R. S., Water Drop Impact Forces. Trans. Amer. Soc. of Agricultural Engineers, 8:1, 69 (1965).
22. Reich, B. M., Design Hydrographs for Very Small Watersheds from Rainfall. Engineering Research Center Report CER 62 BMR 41, Colorado State University, Fort Collins, (July 1962).
23. Webb, H. J., Water Pollution Resulting from Agricultural Activities. Journal of American Water Works Association, 54:1, 83-87 (Jan. 1962).
24. Weibel, S. R., et al., Pesticides and Other Contaminants in Rainfall and Runoff. Journal of American Water Works Association, 58:8, 1075-1084 (Aug. 1966).
25. Wooding, R. A., A Hydraulic Model for the Catchment-Stream Problem. Journal of Hydrology, 3:254-267 (1965).

PART II. DESCRIPTION OF EXPERIMENTAL FACILITY

by G. L. Smith*

1. Introduction

The Rainfall-Runoff Experimental Facility (hereinafter called the Facility) represents a small prototype watershed on which the precipitation, runoff hydrograph, and other hydrologic variables will be generated under controlled conditions. The development of the Facility has been accomplished in three phases: (a) Phase one was the selection of a field site, which could be easily converted to a generalized prototype small watershed; (b) Phase two was the establishment of the basic geometry of the Facility using both the published works of other hydrologists and a careful analysis of the physiographic characteristics of sixty watersheds from 0.1 to 1.0 sq. mi. in size; and (c) Phase three was the design and construction of the Facility with anticipated modification of the preliminary design as dictated by results of initial experimental runs. The first two phases are completed and the third phase is well advanced. Each phase is discussed in detail in the following paragraphs. A brief philosophy of the planned experimental program concludes the description of the Facility.

2. Facility Location

The selection of the field site for the Facility was based principally upon two factors, namely: (a) the area should be easily converted into the initial generalized geometrical shape to be described in the next section, and (b) in order to simulate prototype response of a watershed to precipitation, the area should be about one acre in size. The site selected is shown in Fig. RR1 and is part of the Engineering Research Center located at the Foothills Campus of Colorado State University. The developed Facility area is shown in Fig. RR4.

Additional factors considered in the selection of the site included water supply and availability of electric power. The selected site location is adjacent to a 26-in. diameter pipe line from Horsetooth Reservoir, which will supply water by gravity flow of sufficient head and quantity to develop the desired range of precipitation intensities. Electrical power is also within easy access to the site, and will permit the use of electronic equipment for data acquisition and recording for eventual analysis by digital computer.

3. Facility Geometry

Although no attempt was made to model a specific watershed, it was necessary to decide on a shape and slope for the Facility representative of typical small watersheds. Rather than make a capricious decision, it was decided to study the shapes and slopes of actual watersheds for which data were available.

Generalized shape. Sixty-one small watersheds with a range in drainage area from 0.11 square miles to 0.97 square miles were studied. The most generalized composite basin shape was found to resemble a lemniscate [1, 2, 3]. The polar form of the equation was chosen for adaptation to the field site of the Facility:

$$\rho = L_b \cos p \theta \quad (1)$$

in which

ρ = radius from outlet to rim

θ = angle between baseline and the radius under consideration

L_b = basin length measured from outlet to the most distant point on the perimeter

p = coefficient which determines the rotundity of the basin (when $p = 1$, the basin outline is a circle).

Basin area A is obtained by integration of equation (1) between the limits $-\frac{\pi}{2p}$ and $\frac{\pi}{2p}$, giving

$$A = \frac{\pi L_b^2}{4p}$$

and hence

$$p = \frac{\pi L_b^2}{4A}$$

The degree of approach of the Facility form to the pure lemniscate form is measured by a lemniscate ratio, the ratio of perimeter of the lemniscate to actual perimeter of the basin.

To maintain prototype proportions, a minimum area of one acre was established for the Facility. Furthermore, the generalized basin indicated a length to width ratio of approximately 1.8 to 1. An arbitrary maximum length of 285 feet was selected, and with an area of approximately 44,000 square feet, Eq. (1) becomes

$$\rho = 285 \cos 1.47 \theta \quad (2)$$

Eq. (2) was to be used as a guide in the development of the initial Facility. The final form of Eq. (1) would necessarily depend upon the dimensions of the constructed Facility.

* Assistant Professor, Civil Engineering Department, Colorado State University, Fort Collins, Colorado.

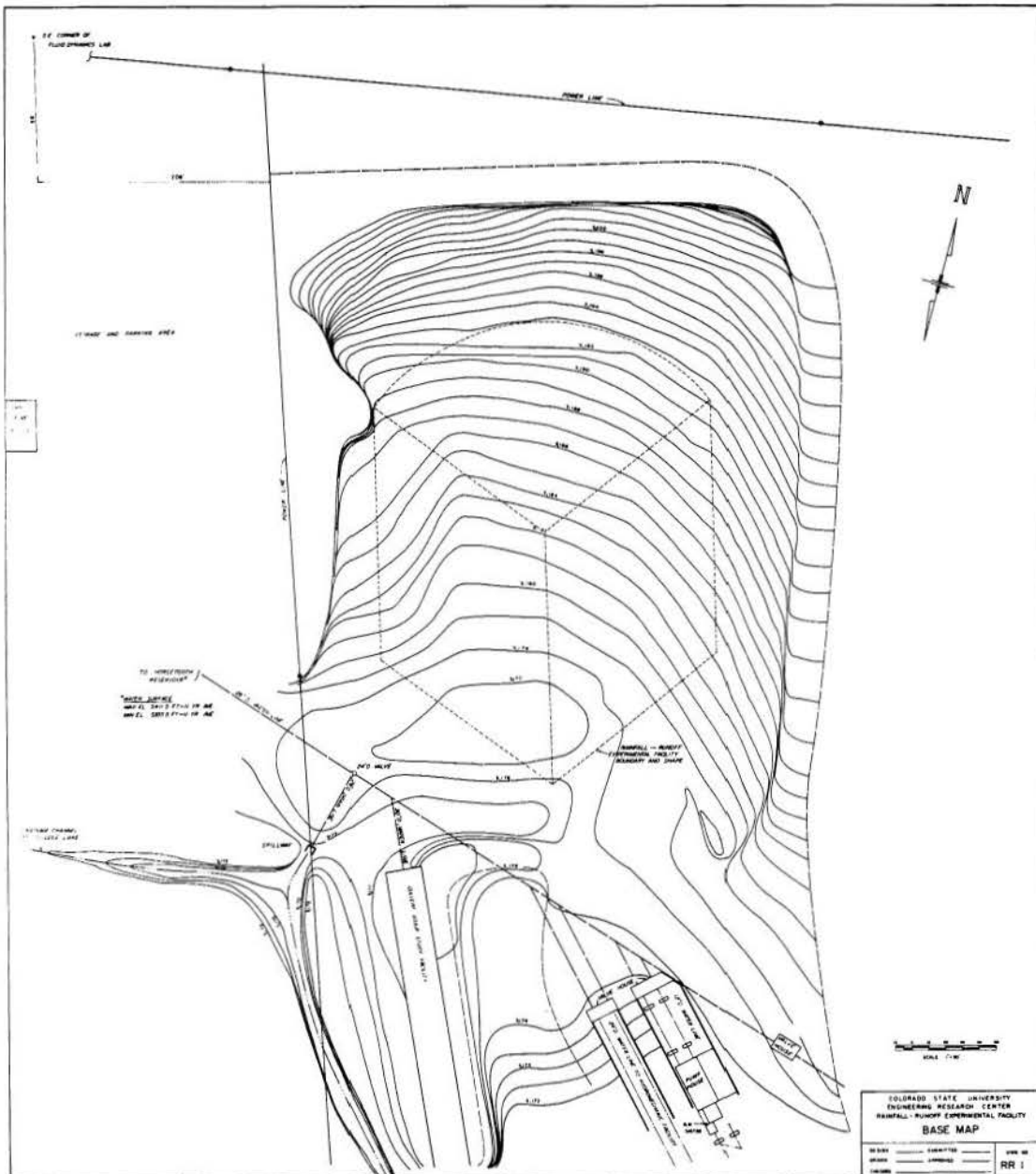

Fig. RR 1 Base Map of Rainfall-Runoff Facility

Generalized slope. From a review of literature it was evident that the longitudinal stream profile could be fitted by an equation expressing the statistical regression of elevation Y as the dependent variable on distance X as the independent variable [4]. Of those examined, the best seems to be of the following form:

$$\log Y = \log a - b \log X \quad (3)$$

in which a and b are constants.

From the watershed study, the longitudinal slope seemed to be related to the geological region in which the basins were situated. For example, the steeper slopes were encountered in igneous-metamorphic and in absolute deformed regions. From a

composite main stream profile plot, a mean slope of approximately 5 per cent was found to be a good fit slope.

Generalized cross section. No suitable mathematical description for the typical cross section of the Facility could be found in available literature.

Initial generalized facility geometry. For the initial geometric shape of the Facility it was decided to compromise between the results obtained in the survey of the small watersheds in nature and the natural shape of the selected Facility site (see Fig. RR1) as discussed in the previous section of this report. Furthermore, it was decided to simplify the initial shape and drainage characteristics as much as possible. The less complex the geometrical

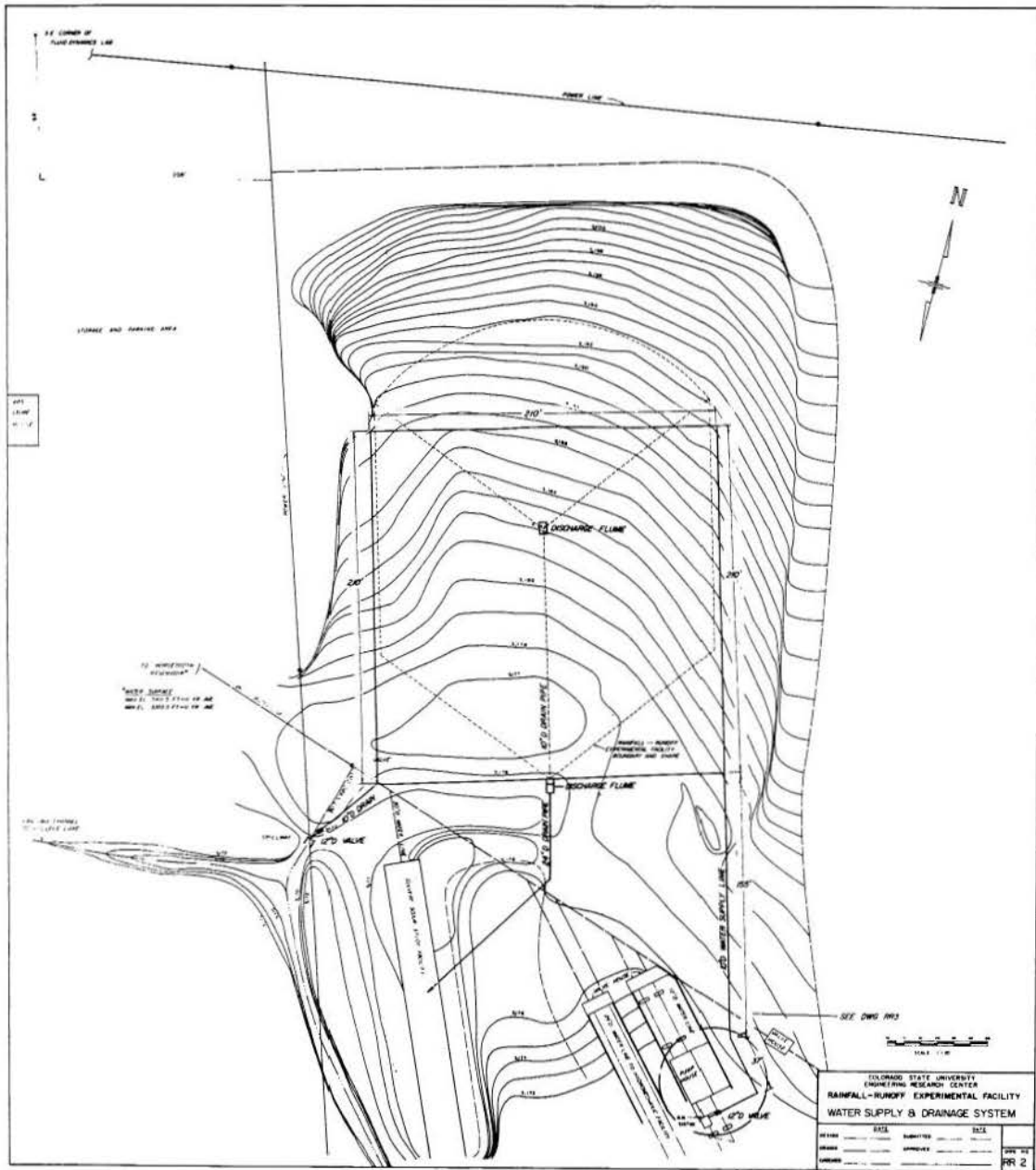

Fig. RR2 Water Supply and Drainage System

shape of the basin, the less difficulty in data analysis as well as in site construction. A description of the initial Facility geometry as developed is given in the following paragraphs.

Two planes, intersecting like the pages of an open book, were selected as the simplest geometric shape that could be fitted to the lower portion of the selected site. The slopes of the two planes were chosen on the basis of balancing the cut and fill in the actual field construction. A slope of 3 per cent was selected for the line of intersection of the two planes, which, in turn, were kept at a 4 per cent slope at right angles to the intersection line. The resultant slope of the two planes was the desired maximum 5 per cent slope, which made an angle of $53^{\circ} 06'$ with the line of intersection. Thus, surface runoff will follow the line of maximum slope.

To avoid damming of the overland flow or runoff, it was decided to form the outline--perimeter--in such a way that it would correspond with the lines of maximum slope. Thus the "arrowhead" shape shown in the lower part of figure RR2 was created. In addition to the two planes, each of which constitutes a watershed, a headwater watershed was necessary to complete the initial generalized shape of the Facility. As an approximation of the lemniscate, a sector of a cone was selected for the shape of the headwater watershed. Its radius is 125 feet and becomes tangent to the "arrowhead" as shown in Fig. RR2. The watershed drains toward the center of the sector at a slope of 5 per cent.

By ditching and small earth embankments, it will be possible to isolate the headwater watershed

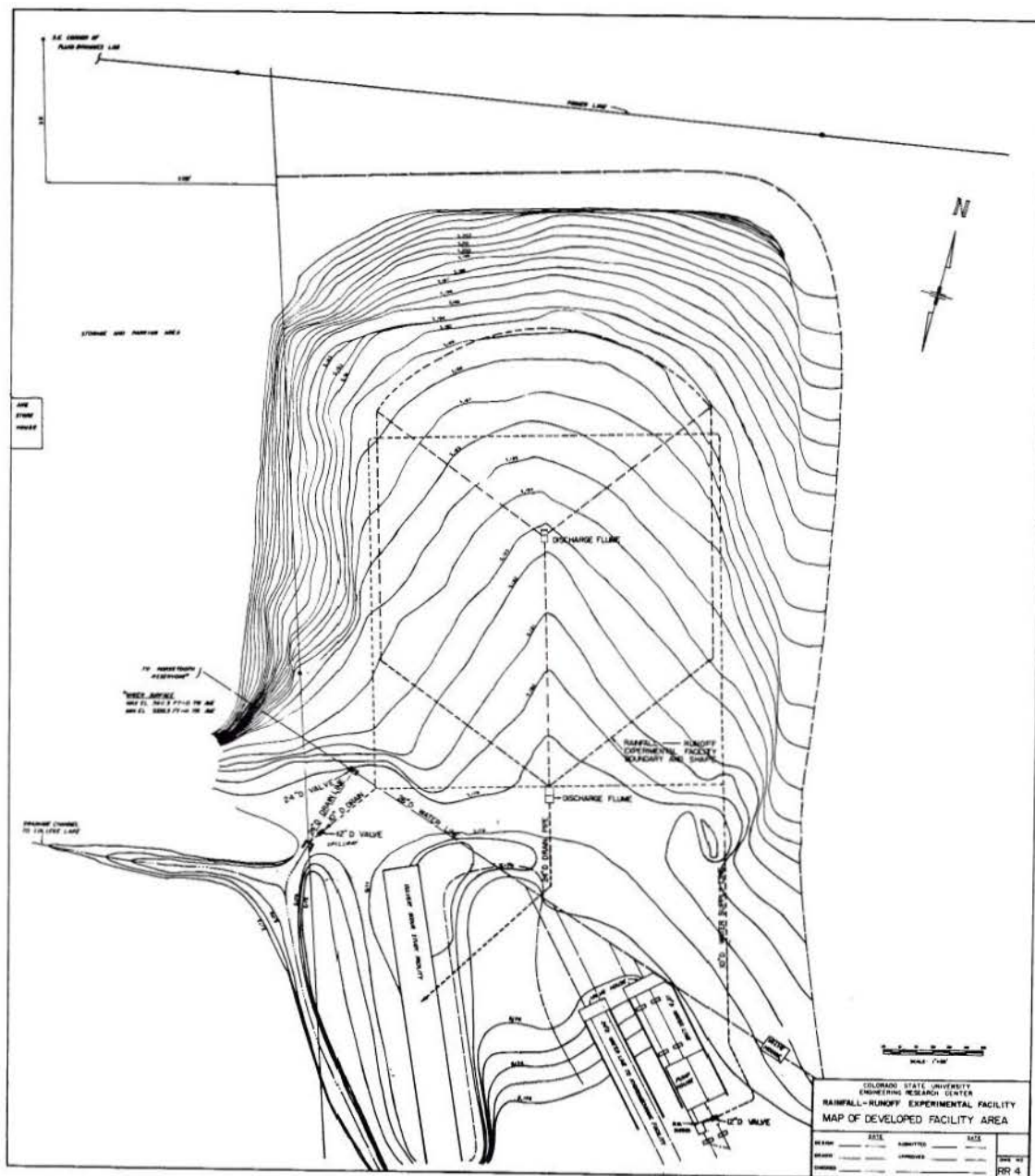

Fig. RR 4 Map of Developed Facility Area

The necessary prerequisites in the operation of the facility are the simulation of natural precipitation, and the subsequent measurement of the precipitation and runoff. Precipitation measurement should be as accurate as possible and should be continuous during any given simulated storm. To accomplish the objective of both accuracy and sensitivity, the capacitance gage system for measuring and recording very small surface waves was adapted to a standard precipitation gage after an experimentation period of several weeks. The developed system is shown schematically on Fig. RR-6, titled Block Diagram Capacitance Gage Analog Rain System, and pictorially in the Figs. RR-7 and RR-8, titled Precipitation Measuring System and Data Acquisition System, respectively.

The system depicted schematically by Fig. RR-6 is a dual system. The capacitance probe in the rain

gage senses the depth of water at a given instant of time. The capacitance gage transmits the depth of water as an electric signal either to a magnetic tape recorder or to the analog-digital converter. The magnetic tape recorder is a high speed response unit for field use. It permits the storage of data for eventual transmission at a slower rate into the analog-digital converter. A calibration standard consisting of power supply, digital voltmeter and frequency counter is used to monitor the data stored on magnetic tape. As noted in Fig. RR-6, the data received by the analog-digital converter may be transmitted to either a printer or a card punch for eventual analysis by computer.

In addition to precipitation, it will be necessary to measure the runoff amount produced by a given rate of precipitation. The H-flume developed by the Agriculture Research Service was chosen for this



OVERALL VIEW OF FACILITY, AUGUST 1967



EXPERIMENTAL RAIN TOWER, AUGUST 1967

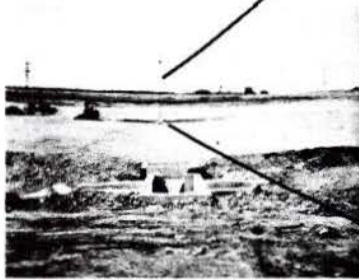

UPSTREAM VIEW OF FACILITY FROM LOWER DISCHARGE FLUME

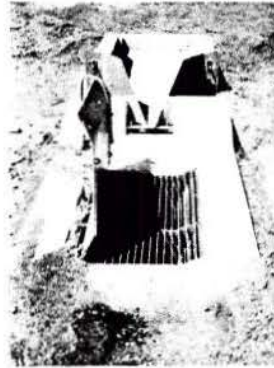

UPPER DISCHARGE FLUME WITH DRAIN LINE OPEN (UPSTREAM VIEW) AUGUST 1967

Fig. RR 5 Pictorial View of Facility Area

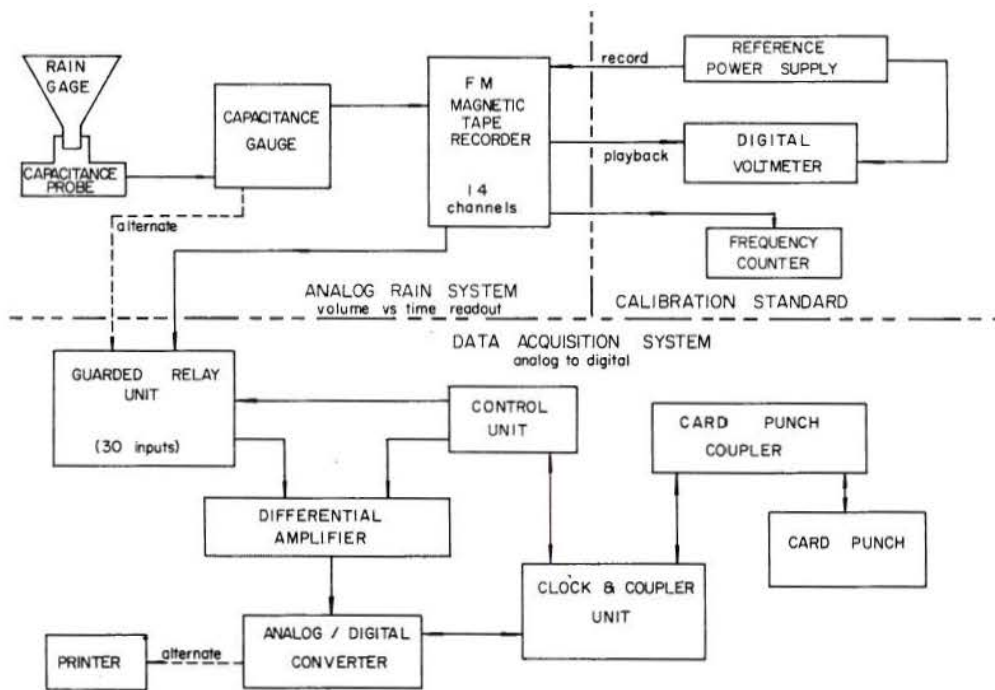

Fig. RR 6 Block Diagram of Capacitance Gage Analog Rain System

purpose. The principal reasons for selecting the H-flume were: (a) simplicity in design and construction, (b) freedom of passage of debris through the measuring section, and (c) below surface construction of the head box minimizing the formation of backwater at the measuring structure. Details of the flumes are given in Fig. RR-9, titled Runoff Measuring Flumes.

In the construction program relative to precipitation and discharge measurement, the flumes have been installed in place in the field at the locations shown on Fig. RR-2. The precipitation gages with capacitance probes have been built and are currently being installed in the field. Each recording gage will represent an equal area determined by a modified form of the Thiessen method of area subdivision. A total of twenty-seven recording gages will be used. For each recording gage, there will be four non-recording gages, which will, in turn, represent sub-areas of equal area. The total number of measurement points over the entire Facility will be 135, or 45 for each sectional watershed.

The last phase of the design and construction program consists essentially of two major parts, namely: (a) the precipitation generating mechanism, and (b) the development of an impervious surface for the initial experimental program. To simulate precipitation, a system of high towers with nozzles are planned as shown in Fig. RR-10, titled Preliminary Rainfall Towers. A single tower has been constructed

and experiments on precipitation pattern for a range of discharges are being made. The final tower design awaits the analysis of the results of the current testing program.

Treatment of the soil to make it impervious is still under investigation. In the shaping of the site, care was exercised in the compaction of the soil in the fill area. The soil having a high clay content was placed in 4 to 6-in. layers under moist conditions. Each layer was compacted by a rubber-tired roller to maximum density. A 2-in. layer of gravel road base placed under compacted conditions, is planned for the preliminary finished surface of the headwater watershed only. A 20 by 20 foot test area of compacted gravel on the watershed has proven virtually impervious during an above-normal natural rain period of several months. Rainfall amounts of up to 0.50-inch per hour were experienced on the basin on several occasions during this period. Infiltration was less than one-half inch and erosion has been minimal. Because of the planned changes in both slope and shape, a permanent surface of concrete or asphalt is not desirable. Cost has eliminated the use of the various plastic type materials commercially available. Tests using various soil-cement mixtures showed that maximum density was obtained with the 8 per cent by volume mixture. Because of the high percentage of bentonite clay in the soil, all soil-cement samples showed undesirable cracking. A paraffin-base liquid

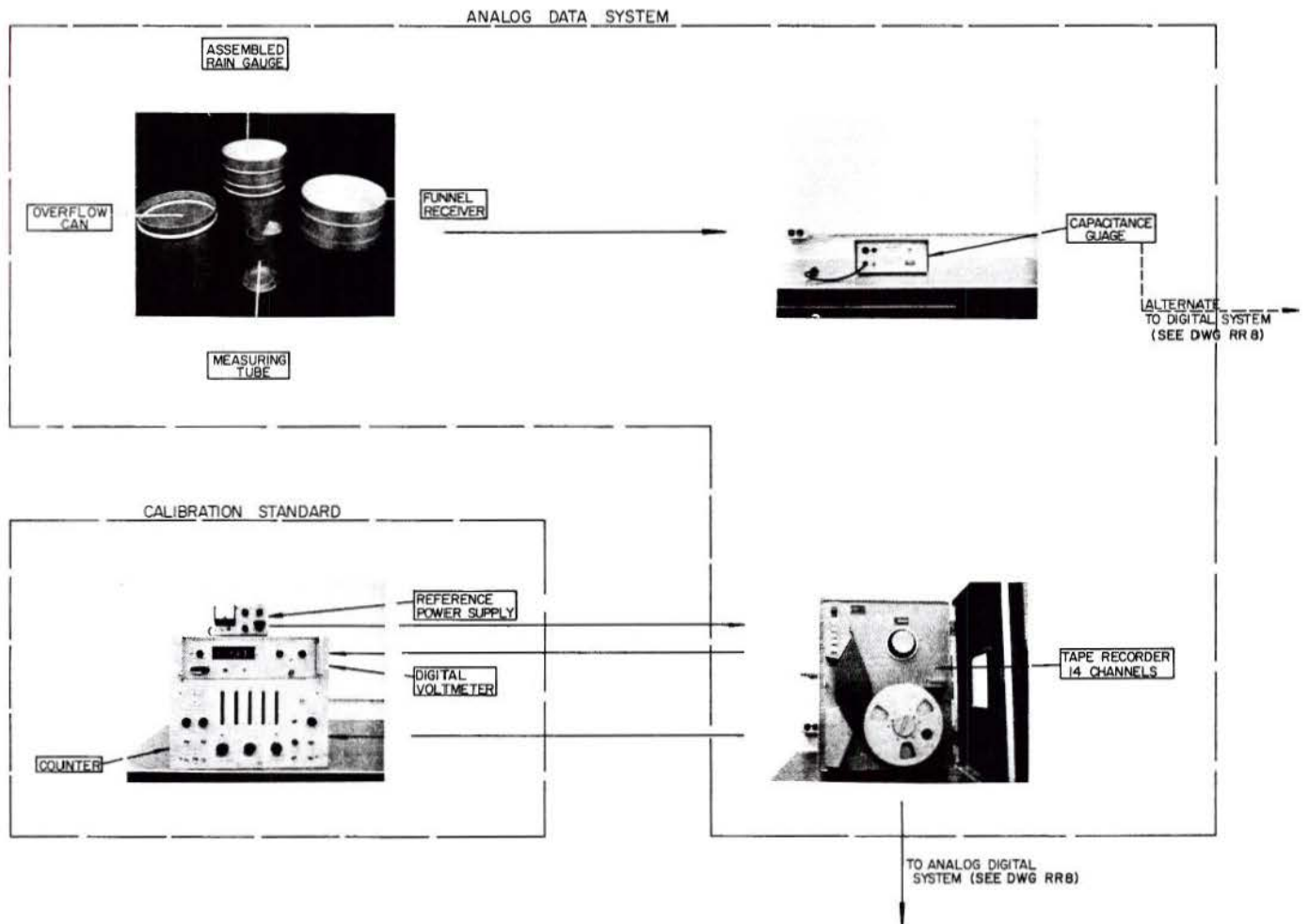

Fig. RR 7 Precipitation Measuring System

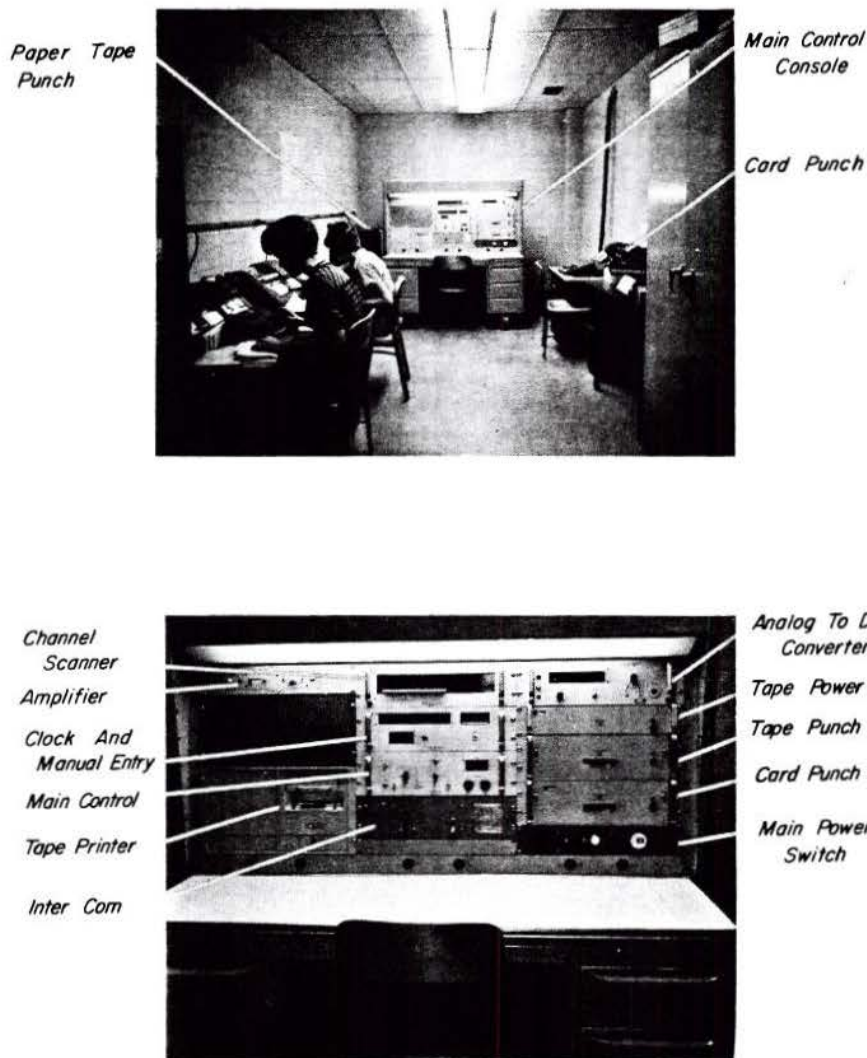

Fig. RR8 Data Acquisition System

under the trade mark of SS-13 is currently being field tested on the Facility site. The liquid has been applied at the rate of 1 gallon per square yard over a 20 x 20 foot area.

5. Experimental Program

The research using the facility will be pursued in a sequential fashion. This is necessary because there is no precedent for comparison in constructing an experimental prototype watershed. The initial experimental tests will utilize the upper, conic, section of the facility with equipment conforming to the preliminary designs. From the analysis of the results of the initial runs, the system design will be checked and modified before the facility is completed.

Watershed response experiments. The preliminary runs of the facility will provide data for analyzing watershed response as well as for testing the facility itself. The first series of tests will examine the response of overland flow to variations

in rainfall rate, because the conic section of the facility provides overland flow to the upper H-flume. The differential equations for overland flow on a conic section will be studied in a related project and the results from the experimental facility will be compared with the solutions obtained by computer methods. Simple storage models will also be examined and their responses compared with the runoff from the experimental facility.

After the facility is completed, the range of experiments will be broadened. As stated above, the facility can provide three different geometric patterns: the conic section, the intersecting flat planes and the entire watershed. The runoff from the conic section is measured by the upper flume and can be either permitted to enter the channel flow reach or diverted by the underground drainage pipe to by-pass the channel. Thus, the effects shape and of channel flow will be investigated in the early runs of the completed facility. The predictions of more complex computer models will also be compared with the response of the facility.

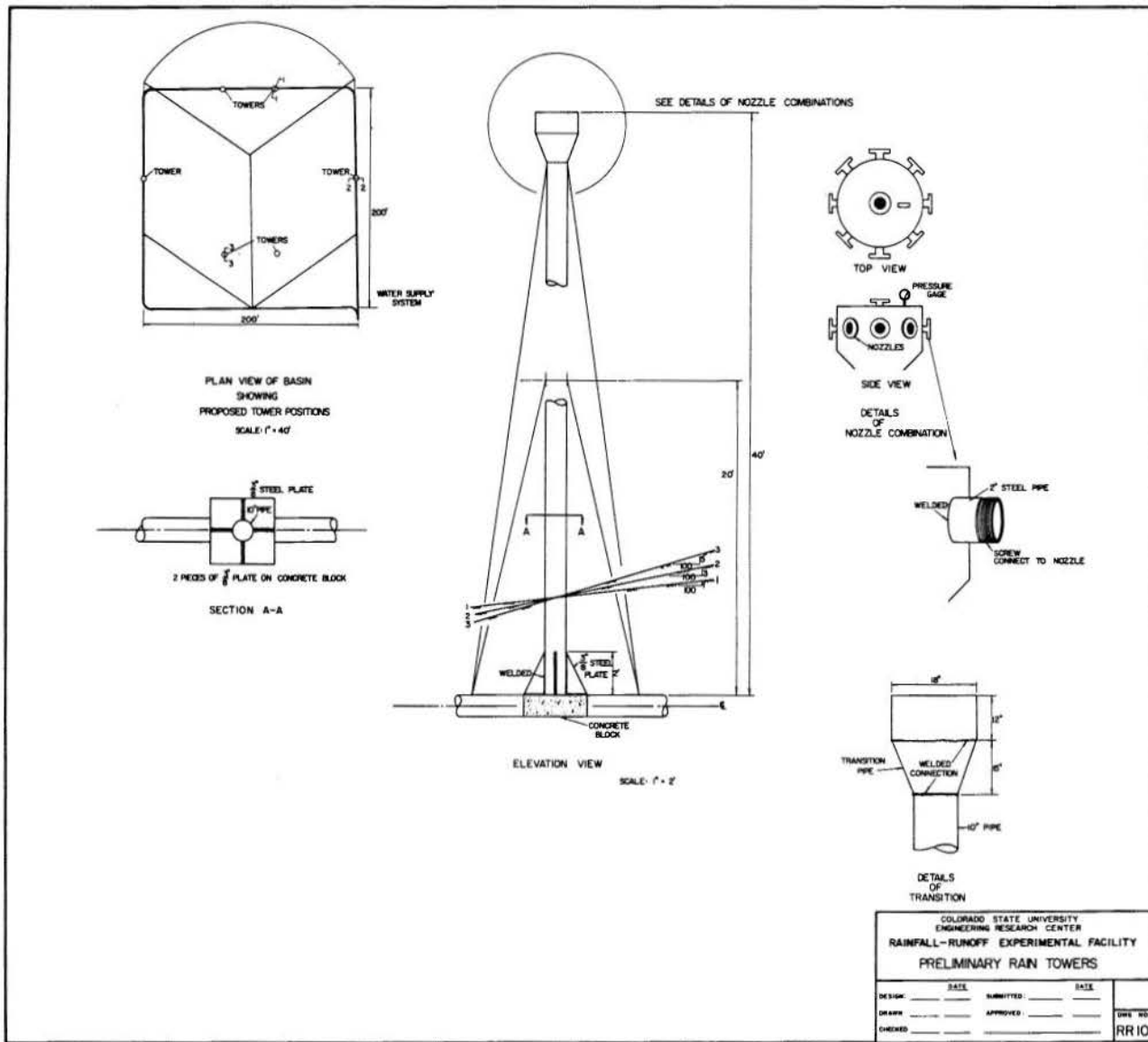

Fig. RR10 Preliminary Rainfall Towers

BIBLIOGRAPHY

1. Strahler, Arthur N., Section 4-II of "Handbook of Applied Hydrology," by Ven Te Chow, Editor in-Chief, McGraw-Hill Book Co., New York, 1964, p. 4-51 and 4-56-59.
2. Chorley, R. G., Donald E. G. Halm and H. A. Pogorzelski, "A New Standard for Estimating Drainage Basin Shape," Am. J. Sci., 1957, Vol. 225, pp. 138-141.
3. Morisawa, M. E., "Measurement of Drainage-Basin Outline Form," J. Geol., 1958, Vol. 66, pp. 587-591.
4. Broscoe, A. J., "Quantitative Analysis of Longitudinal Stream Profiles of Small Watersheds," Project NR 389-042, Tech. Rept. 18, Columbia University, Dept. of Geology, ONR, Geography Branch, N. Y., 1959, pp. 5-6.

PART III. A SURVEY OF WATERSHED RESPONSE MODELS

CHAPTER I

A HISTORICAL REVIEW

by Trevor Dickinson*

1. Time Distribution of Runoff

General approach. An understanding of the basic rainfall-runoff relationship is one of the central problems of hydrology. This portion of the hydrologic cycle has received much attention in recent years, with results that have been varied, contradictory, and often inconclusive. It seems worthwhile that the literature should be critically reviewed, summarized, and appraised in an attempt to delineate accomplishments in this area. It is the purpose of this study to initiate such work.

The importance of studying the time distribution of runoff as an indication of watershed response was first acknowledged in the Report of the Committee on Floods (1930), of the Boston Society of Civil Engineers. In that report it was stated that:

"The relationships on any particular watershed are so involved that it is practically impossible to determine the effect of each of these factors analytically, but the various factors are all reflected in the flood hydrographs. It is believed that flood hydrographs afford the best basis for the study of the flood drainage area characteristics of a stream. . . . It is (also) believed that the flood hydrograph resulting from a given storm on a stream is the best key to the behavior of that stream with other storms."

Not only was the study of the time distribution of runoff encouraged, but also it was accepted as a model of the response of a watershed, having particular characteristics, to a storm also characterized in a particular way. The stage was set for consideration of direct runoff as the output of a watershed system responding to a given rainfall input.

In the light of previous research, the Report of the Committee on Floods (1930) can be seen to be a significant contribution. Prior to 1930, attention had been focused on the study and determination of peak discharge relationships. These studies, initiated in the U. S. by sanitary engineers and continued by both highway and conservation researchers, has been of major importance, particularly in the realm of culvert and small bridge construction. However, the Boston committee's suggestion to study the entire hydrograph rather than only the peak can be

recognized as a real step toward the understanding of the rainfall-runoff relationship. The literature regarding peak flow considerations has been well annotated by such authors as Jarocki (1953), Reich (1960), and Chow (1962), and is not included in this review.

Conversion of rainfall to runoff. The literature regarding watershed response can be classified into two general groups. The majority of the research has dealt with obtaining the time distribution of direct surface runoff at a point, given the volume and distribution of the effective rainfall. The second group of investigations has studied the total rainfall-runoff relationship, including estimation of the volume of effective rainfall from consideration of the loss functions experienced by the storm rainfall. The latter group includes total models of response, whereas the larger group deals with direct runoff response models.

Studies regarding the conversion of effective rainfall to hydrographs of streamflow at the catchment outlet stem primarily from unit hydrograph theory. The theory has been modified, applied, verified, used for analysis, and used for synthesis. It remains the basis of most practical work. The concept of the instantaneous unit hydrograph along with various storage and routing ideas has led to numerous theoretical response models. From these theoretical viewpoints, analog models have also been formulated. Recently, physical laboratory models have become popular as research tools. These various approaches have been utilized to study the formation of a direct runoff hydrograph from a known effective rainfall.

On the other hand, a few rainfall-runoff models have been investigated with emphasis on the conversion of rainfall to effective rainfall. This phase of the problem has not received the attention given to the direct runoff problem and remains largely unanswered. Although many of the physical concepts have become better understood in recent years, a satisfactory model has not yet been developed. The approaches include microscale hydrologic studies and watershed models using computer techniques. The microscale studies involve both small plot research and urban investigations. The accuracy of predictions based on these models has generally been inversely proportional to the size of the watershed considered.

* Former Graduate Research Assistant, Civil Engineering Department, Colorado State University, Fort Collins, Colorado, now Assistant Professor, School of Agricultural Engineering, University of Guelph, Guelph, Ontario, Canada.

Baseflow separation. Research concerned with the analysis stage of direct runoff models has had to devise methodology to separate baseflow from the total flood hydrograph. The term baseflow has usually been defined to be that flow which enters the stream channel from subsurface storage. The separation procedures have involved three aspects: (i) the time when direct surface runoff begins, (ii) the time when surface runoff ends, and (iii) the time distribution of baseflow during the interval of surface runoff. Many of the techniques applied in the literature have been summarized graphically by Dickinson (1963), and are included in fig. 1.

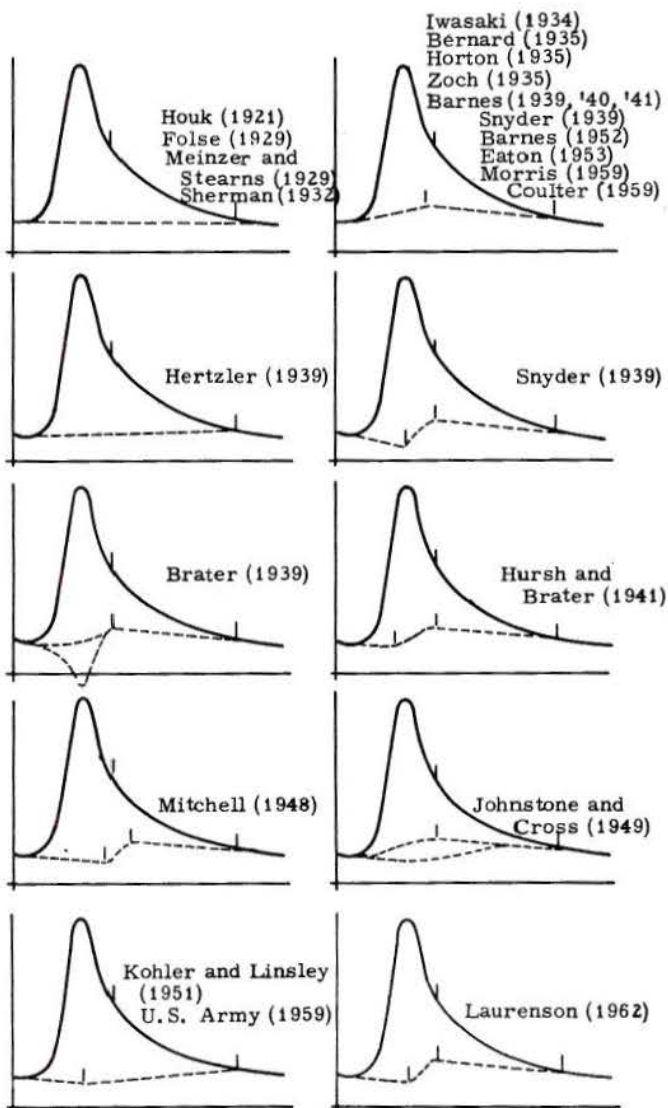

Fig. 1 Hydrographs illustrating methods of baseflow separation.

The first approach, referred to by Houk (1921), Meinzer and Stearns (1929), Folse (1929), and Sherman (1932), involved the joining of the low points of a record of runoff by straight or arbitrarily curved

lines. As early as 1903, Horton had observed that the falling limb of a streamflow hydrograph during a period of drought was a depletion curve having the characteristic exponential decay equation,

$$Q_t = Q_0 e^{-ct}$$

However, Iwasaki (1934) appears to have been one of the first to use an average depletion curve as an aid in separating baseflow. Many authors have since employed the normal depletion curve either with an empirically or mathematically defined shape. Brater (1939) considered separation of baseflow from a physical viewpoint. He felt that the groundwater contribution could be negative for a short interval when the stream rose more rapidly than the groundwater gradient. Brater (1939) also found that the peak baseflow occurred at a time coincident with the equilibrium time of the watershed, at the inflection point on the recession limb. Hursh and Brater (1941) also discovered a significant delay before a rise of baseflow occurred. Barnes (1940, '42, '52) recognized three stages of depletion from surface, interflow, and groundwater flow, where interflow represented a subsurface flow of water which had not reached the water table. Roche (1963) has taken exception to this concept of interflow and suggests that it is more closely related to surface flow through vegetation. Most authors have included interflow with surface runoff in their separation procedures.

Other methods of separation have been considered. Linsley and Ackermann (1942) employed recession curves for both surface and groundwater flow, as well as numerous plots involving surface and groundwater flow with surface and groundwater storage. The method was too laborious for common usage and did not guarantee increased accuracy of separation. Merriam (1951) used an empirical envelope approach to determine recession constants for groundwater and surface flow. Although aspects of salt concentration and radioactive tracers have not been used for separation purposes directly, the work of Lenz and Sawyer (1944) and of Pilgrim (1966) suggests that such approaches might be feasible.

One must conclude from a consideration of the literature on baseflow separation that a method has not yet been determined for adequately separating baseflow from surface flow. All techniques are essentially analytical tools for achieving an approximate division. Although different methods of separation give significantly different direct runoff hydrographs and unit hydrographs, as shown by Hertzler (1939), Eaton (1953), Coulter (1959), and Dickinson (1963), there is no way of determining at present which method is most applicable. The importance of correct baseflow separation is a function of the size and nature of the watershed, or, in other words, of the relative volume of baseflow and its distribution in time.

2. Analysis of Direct Surface Runoff.

Unit hydrograph theory

The concept. The unit hydrograph approach to analysis and synthesis of flood hydrographs has been the most widely used in practice during the past

thirty years. The concept, introduced by Sherman (1932), a member of the original Boston Committee on Floods, was the first to consider the existence of a unique direct runoff hydrograph for a storm of given duration and volume over a particular watershed. This unique response, termed the unit hydrograph or unitgraph, was originally defined as the hydrograph representing a selected volume of surface runoff from a given basin for a one day rainfall. The hypothesis on which Sherman (1932) based the unitgraph was "that in any drainage basin, surface runoff from rainfall that is distributed with satisfactory uniformity as to area and time and that occurs in a given unit of time will produce hydrographs in which the bases are approximately equal and the ordinates vary directly with the intensity of net rainfall. The prefix "unit" referred to the specified unit of time in which the storm occurred, and not to the runoff volume which has often been chosen to be a unit depth over the watershed.

The roots of the unit hydrograph concept were grounded in the report of the Committee on Floods (1930), when it was observed that the time bases of flood hydrographs at a selected stream station were approximately equal, and that the peak flow tended to vary directly with the total runoff volume. Sherman (1932) further found that all ordinates of the hydrograph were proportional to the volume of surface runoff, that direct runoff hydrographs were independent of previous runoff events and simple hydrographs could be linearly superimposed to constitute complex hydrographs, and that a definite duration could be attached to the storm producing the hydrograph. The theory was also based upon a rainfall that was uniform in time and area, that was of high intensity, and whose duration was less than the time of concentration of the watershed.

More recently, the unit hydrograph has been expressed as a portion of a summation form of the convolution integral, used for determining a functional relationship for the direct runoff hydrograph. That is,

$$Q(t) = \sum_{i=1}^n u \left[\Delta t_0, t - (i-1) \Delta t \right] I_i \Delta t$$

where the ordinate at time t of the unitgraph having unit duration Δt_0 is represented by $u \Delta t_0, t$; the effective rainfall for a given storm is considered to consist of n blocks of intensities I_i and of the same duration Δt_0 ; and $Q(t)$ is the ordinate of the direct runoff hydrograph. This approach has led to the mathematical analysis of direct runoff hydrographs to obtain unitgraphs, and to the mathematical synthesis of direct runoff hydrographs.

Modification. Several modifications have been made to unit hydrograph methodology. They have served to strengthen the approach as a practical tool rather than to alter the basic assumptions. Bernard (1935) expressed the unitgraph in terms of

the percentage of direct runoff which occurred in successive time intervals. He termed his hydrograph a distribution graph. Smith (1941) modified Bernard's approach by employing a smooth curve through the discrete points and used instantaneous distribution coefficients. Morgan and Hulinghorst (1939) introduced the concept of the S-curve to represent the watershed response to a continuous uniform rainfall. The utility of this concept was in the determination of unitgraphs for storms of different durations. The algebraic difference between two S-curves lagged by a selected time interval was shown to yield a unitgraph for a storm of duration equal to the lag interval. Cuenod (1956) referred to the S-curve as "l'hydrogramme indiciel", or characteristic hydrograph. Like unitgraphs, S-curves were indices of watershed response.

Methodology. There have been numerous accounts of the standard methods of hydrograph analysis for the determination of unitgraphs. Some of the most informative descriptions have been given by Mitchell (1948), Barnes (1952), and the U. S. Army Corps of Engineers (1963). A few other approaches have been developed in order to obtain the best unitgraph estimate. Collins (1939), and later Fekete (1954), employed a trial and error procedure for analyzing complex hydrographs. An assumed unitgraph was employed on all rainfall events except the largest. Then a unitgraph was obtained from the largest runoff event and compared with the assumed one. The procedure was repeated until the assumed and computed unitgraphs agreed favorably. Snyder (1955) employed the method of least squares in order to obtain the distribution coefficients of the distribution graph. Barnes (1959) used what he termed a method of progressive addition, which involved successive estimation of the distribution coefficients with continuous checking of the estimated and actual hydrographs.

Verification. The practicability of the unitgraph theory has been verified by literally hundreds of researchers. Although the approach has been seriously questioned in theory, its use in practice cannot be disputed. Not only has the approach been verified on large basins for storms of long duration, as used by Sherman (1932), but also it has been used successfully on all sizes of watersheds. Some representative articles have been written regarding the application and suitability of the unitgraph approach by Horner and Flynt (1936), McCarthy (1938), Pettis (1938), Brater (1939), Hertzler (1939), Hathaway (1941), Morris (1959), Remenieras (1960), Coulter (1961), and Watson and Body (1961). A list including these and other researchers, their regions of study, and the watershed areas involved is given in Table 1. Inferences regarding the use of unitgraphs have reflected the sizes of the watershed areas.

Correlation and synthesis. As has been stated, Sherman (1932) suggested that there was a unique response model for each storm duration for each watershed. The characteristics of this response were, therefore, a function of watershed parameters. Further, it was stated that the storm rainfall should be distributed "with satisfactory uniformity as to

Table 1 Location and area of watersheds studied by various researchers,

Author	Watershed	
	Location	Area (sq. miles)
Boston Society (1930)	U. S. A.	23.9 to 2,525
Sherman (1932)	Illinois and New York, U. S. A.	510 to 5,000
Bernard (1935)	Ohio, U. S. A.	500 to 6,000
Horner & Flynt (1936)	St. Louis, Missouri	small urban areas
Hoyt (1936)	Ohio, U. S. A.	5,980
Pettis (1938)	U. S. A.	--
Snyder (1938) (1943)	Appalachian Highlands, U. S. A.	10 to 10,000
Collins (1939)	Ohio, U. S. A.	1,398
Brater (1939)	Michigan, U. S. A.	0.0073 to 2.93
Barnes (1939)	Iowa, U. S. A.	1,500 to 3,230
Snyder (1939)	Pennsylvania, U. S. A.	1,147
Laden, Reilly, Minnotte (1940)	Ohio, U. S. A.	<800
Hathaway (1941)	U. S. A.	190 to 8,000
Hursh and Brater (1941)	Michigan, U. S. A.	0.0625
Linsley (1943)	Sierra Nevada & Coast Range, U. S. A.	100 to 3700
Lucas (1949)	Ohio, U. S. A.	139 to 331
Kohler and Linsley (1951)	Washington, U. S. A.	--
Fekete (1953)	Australia	560 to 1,850
Eaton (1953)	Australia	48 to 178
Barnes (1952)	Colorado, U. S. A.	--
O'Kelly (1955)	Ireland	--
Snyder (1956)	Tennessee, U. S. A.	0.0055 to 2.68
Villares (1956)	Illinois, U. S. A.	<200
Beyer (1957)	U. S. A.	--
Nash (1958)	England	--
Barnes (1959)	East Pakistan & U. S. A.	3,800
Morris (1959)	Canada	--
Coulter (1959)	New Zealand & Australia	13 to 600
Nash (1960)	England	--
Willeke (1962)	U. S. A.	0.0007 to 0.074
Body (1962)	Australia	4,150
Minshall (1960)	U. S. A.	0.0425 to 0.453
Body & Watson (1962)	Australia	4,150
Laurenson (1962)	Australia	34.6

area and time". Since, in practice, a unitgraph representing runoff generated by rainfall of perfectly uniform areal and time distribution is seldom if ever found, several workers have questioned the effect of storm characteristics on unitgraph shape. Therefore, much research has investigated the correlation among various unit hydrograph, watershed, and storm characteristics. Such correlations have often been used to advance methods of synthesizing unit hydrographs for ungaged watersheds. Table 2 has been prepared as a summary of the parameters studied by many individuals.

Several researchers have also reasoned that a single dimensionless unit hydrograph could be conceived which could be applied to most if not all watersheds. In some instances the dimensionless shapes were merely observed to be similar; in other cases, the factors used to render the graphs dimensionless were correlated to watershed parameters for syn-

thesis purposes. Parameters involved in a number of these studies are listed in Table 3.

Instantaneous unit hydrograph. The Committee on Floods (1930) suggested that the hydrograph due to an instantaneous storm could provide a good indication of watershed response. This suggestion was another example of how forward-looking this committee was, as the concept of the instantaneous unit hydrograph was not fully introduced until the works of O'Kelly (1955) and Nash (1957). The instantaneous unit hydrograph is now recognized as the unit hydrograph resulting from a storm rainfall which has an infinitesimally small duration. Therefore, it is a concept or a conceptual response model rather than a physically realizable hydrograph. Using the linear assumptions of basic unit hydrograph theory, each ordinate of the direct runoff hydrograph may be expressed as the convolution, or Duhamel, integral

Table 2 Hydrograph, watershed, and storm parameters considered in watershed response literature

Author	Hydrograph Characteristics	Watershed Characteristics	Effective-Storm Characteristics	General Comments
Sherman (1932 b)	Peak discharge (uh)*	Area	-	General inference used to transpose uh
Bernard (1935, 1936)	Time distribution of runoff (dg)*	Watershed factor--watershed shape factor, length, channel shape factor, channel slope	Duration, intensity, recurrence interval	Graphical correlation, with possibilities for synthesis of dg
Horner & Flynt (1936)	Time distribution of rising and falling limbs (srh)*in terms of lag time and peak runoff rate	-	-	Mathematical description of small urban hydrographs, in terms of hydrograph parameters
Horton (1936, 1938)	Time distribution of rising limb (srh)	Surface slope, length, roughness	Intensity	Mathematical description of rising limb of small plot hydrographs
McCarthy (1938)	Peak discharge, lag time, base time (uh)	Area, slope of area-elevation graph, stream pattern	-	Graphical correlation for uh synthesis
Snyder (1938, 1943)	Peak discharge, lag time, base time (uh)	Area, length, length to center of area	Duration of rainfall excess	Mathematical relationships for uh synthesis
Brater (1939)	Peak discharge (uh)	Area	-	General inferences
Hertzler (1939)	Peak discharge, base time (dg)	Area, vegetative cover	-	Graphical inferences
Sherman (1939)	Peak discharge, lag time (uh)	-	Areal distribution	General inferences
Kirpich (1940)	Time of concentration (th)*	Slope	-	Mathematical relationships for small agricultural watersheds
Laden, Reilly, Minnotte (1940)	Peak discharge, lag time, base time, S-curve (uh)	Area, length, length to center of area	-	Mathematical & graphical relationships for uh synthesis
Meyer (1940)	Time of concentration (th)	Area	-	General inference for transposing uh
Hathaway (1941)	Peak discharge (uh)	Area	-	Graphical inference
Hicks (1942)	Time of concentration (srh)	Slope, length, roughness	Intensity	Mathematical expressions for laboratory and plot surfaces
Horner & Jens (1942)	Time distribution of runoff (srh)	Slope, length, roughness	Intensity	Mathematical expression for small plot hydrographs

Table 2 - continued

Author	Hydrograph Characteristics	Watershed Characteristics	Effective-Storm Characteristics	General Comments
Linsley (1943)	Peak discharge, lag time, base time (uh)	Area, length, length to center of area	Duration of rainfall excess	Mathematical relationship for uh synthesis
Jetter (1944)	Time distribution of runoff (dg)	Slope, length	Areal distribution	Graphical inferences
Williams (1945)	Peak discharge rate, lag time (uh)	Length, length to center of area	-	Mathematical relationships for urban uh synthesis
Mitchell (1948)	Lag time (uh)	Area	-	Mathematical expression for uh synthesis
Lucas (1949)	Clark's parameters of C and K (iuh)	Length, channel-slope, width, land slope, stream branching factor	-	Mathematical expressions for iuh synthesis
Soong (1950)	Mean time, standard deviation about the mean time (uh)	-	Distance from rainfall center to outlet, concentration coefficient, spread coefficient	Mathematical inferences
Edson (1951)	Time distribution rate per square mile (iuh)	Shape, channel network, channel slope	-	Mathematical expression for iuh in terms of general watershed parameters
Taylor & Schwartz (1952)	Peak discharge, lag time (uh)	Area, length, length to center of area, channel slope	Duration	Graphical correlations for uh synthesis
Warnock (1952)	Peak discharge, lag time, base time (dg)	Area, shape, land slope	-	Graphical inferences
Eaton (1954)	Clark's parameters of C and K (iuh)	Area, length, branching factor	-	Graphical expressions for uh synthesis
Fekete (1954)	Time distribution of runoff (uh)	-	Areal distribution	uh of similar storm patterns used for synthesis
O'Kelly (1955)	O'Kelly's parameters of T and K (iuh)	Slope	-	Table of values for iuh synthesis
Dooge (1956)	Time distribution of runoff (uh)	Area, slope	-	Mathematical inferences and expressions for uh synthesis
Villares (1956)	Peak discharge, lag time (uh)	Area, slope	-	Mathematical expressions for uh synthesis
Mockus (1957)	Peak discharge (uh)	Area	Duration	Peak rate equation plus dimensionless uh to synthesize
Hickok, Keppel, Rafferty (1959)	Peak discharge, lag time (uh)	Area, land slope, drainage density, length to center of area, width	-	Mathematical expressions for uh synthesis

Table 2 - continued

Author	Hydrograph Characteristics	Watershed Characteristics	Effective-Storm Characteristics	General Comments
Minshall (1960)	Peak discharge, lag time (uh)	Area	Time and areal distribution	Graphical correlations for uh synthesis
Nash (1960)	1st & 2nd moments of iuh (iuh)	Area, land slope	-	Mathematical expressions for iuh synthesis
Amorocho (1961)	Nash's parameters of n and c (iuh)	-	Intensity	Mathematical inferences
Coulter (1961)	Time distribution of runoff (uh)	-	Time distribution, duration	General inferences
Gray (1961)	2 parameter Gamma function, lag time (uh)	Length, channel slope	-	Mathematical expressions for uh synthesis
Rainbird (1961)	Time distribution of runoff (drh)*	Moisture	Duration, time distribution	Graphical correlation and inferences
Body & Watson (1962)	Peak discharge (uh)	-	Areal distribution	Statistical inference
Eagleson (1962)	Peak discharge, lag time, base time, time interval between points of 50% peak flow and between points of 75% peak flow	Slope, length	-	Graphical correlations for uh design for sewer inflow
Getty & McHughs (1962)	Peak discharge (uh)	Area, channel slope, length, length to center of area	-	Mathematical expression for uh peak
Viessman & Geyer (1962)	Peak discharge lag time, standard deviation of normal distribution producing equivalent rising limb, time distribution of runoff (drh)	Area, channel slope, roughness	Intensity	
Dickinson (1963) & Ayers (1965)	Peak discharge, lag time (uh)	-	Areal and time distribution	Statistical inferences
Henderson (1963)	Peak discharge (iuh)	-	Time distribution	General inferences
Holtan & Overton (1963)	Peak discharge, lag time (drh)	-	Duration	Mathematical expressions for synthesis
Wu (1963) et al (1964)	Lag time, recession coefficient (uh)	Area, length, channel slope	Areal and time distribution	Methodology for synthesis
Harbaugh (1966)	Time distribution of runoff (drh)	Shape, length, slope, roughness	Intensity, duration	General inferences
Pilgrim (1966)	Time of concentration, peak discharge (th)	-	Duration	Graphical inferences

*uh - unit hydrograph; dg - distribution graph; srh - surface runoff hydrograph; th - total hydrograph; drh - direct runoff hydrograph.

Table 3 Dimensionless unit hydrographs

Author	Dimensioning Parameters and Characteristics Correlated with them for:		Comments
	Time	Discharge	
Langbein (1940)	Time lag between centers of mass of effective rainfall and direct runoff	Peak discharge	Actual S-curves were made dimensionless and found to appear equivalent for areas ranging from 30 to 4,000 sq. mi.
Commons (1942)	Time unit (hrs) = $\frac{720 \times \text{Vol. (ac/ft)}}{1196.5 \times \text{Peak (cfs)}}$	Flow unit (cfs) = $\frac{\text{Peak flow (cfs)}}{60}$	A standard dimensionless plot with the base time divided into 100 units, the discharge into 60 units, and the area of 1196.5 sq. units was presented for synthesis purposes, given the peak flow and the volume.
Williams (1945)	Time lag time to peak (length, length to center of area)	Peak discharge (in terms of time lag)	A curve was presented whose recession time was four times the rising time, and the parameters were related to watershed characteristics.
Mockus (1957)	Time to peak (time of concentration)	Peak discharge (area, volume duration, time to peak)	A dimensionless plot was given and related to storm and watershed characteristics.
Hickok, Keppel, Rafferty (1959)	Time lag between center of mass of intense rainfall and the hydrograph peak. (area, land slope, drainage density)	Peak discharge (time lag, volume)	A standard dimensionless hydrograph was related to watershed characteristics for synthesis purposes.
Bender, Roberson (1961)	Time base	Peak discharge (duration)	An average dimensionless unitgraph was derived for synthesis purposes.
Kleen, Andrews (1961)	Time to peak (duration, time of concentration)	Peak discharge (area, duration, time of concentration)	The dimensionless distribution graph approach of the S. C. S. was presented.
Ogrosky (1962)	"	"	"
Kleen (1964)	"	"	"
Lienhard (1964)	Time lag	Characteristic of storm intensity (usually peak discharge)	A dimensionless unitgraph was determined purely by a probability approach. It was virtually independent of watershed properties.

$$Q(t) = \int_0^{t' \leq t_0} u(t - \tau) I(\tau) d\tau$$

in which the instantaneous unit hydrograph is expressed by the kernel function, $u(t - \tau)$; the effective rainfall, $I(\tau)$, is the input function and has duration t_0 ; $t' = t$ when $t \leq t_0$, and $t' = t_0$ when $t > t_0$.

Langbein (1940) was the first to recognize that the S-curve could be used to obtain the equivalent of the instantaneous unit hydrograph. He calculated the maximum slope of the S-curve to obtain the peak of a hydrograph resulting from an instantaneous storm. Chow (1962) and Henderson (1963) used the derivative at each point of the S-curve to obtain the entire instantaneous unit hydrograph. Other methods

of determining the instantaneous unit hydrograph from existing data have also been advocated.

Cuenod (1956) was one of the first to study the convolution integral in this regard. He applied a mathematical differentiation of the integral to obtain the desired graph from input and output data. Nash (1957) developed a method of moments to obtain parameters of the instantaneous unit hydrograph in terms of moments of the rainfall and runoff data. A procedure employing harmonic analysis was proposed by O'Donnell (1960). This analysis involved series

representation of the input, the output, and the instantaneous unit hydrograph. Eagleson (1966) made use of the Wiener-Hopf equations for optimum linear systems in order to achieve optimum realizable instantaneous unit hydrographs.

Other conceptual models

Various theoretical conceptual models have been hypothesized to describe the conversion of effective rainfall to runoff. Virtually all models have treated the drainage network as some combination of channel and storage components, the specific nature of the components and their interrelationships characterizing each model. The output of most of the models has been in the form of an instantaneous unit hydrograph, although it was not called such until the last 1950's.

A basic component of many recent models, the time-area-concentration diagram, was considered by Ross (1921). He used time contours to account for linear translation effects throughout the watershed. Zoch (1934) was the first to recognize that both translation and storage effects were realized in the runoff process. Incremental areas were lagged by travel times, and the rate of runoff was assumed to be proportional to the rainfall remaining with the soil at that time. Sherman (1940) used a similar procedure, although the detention reservoir had slightly different storage characteristics. In a later portion of his original work, Zoch (1935) accepted the time-area-concentration diagram as the inflow hydrograph and routed it through a single linear reservoir to obtain the equivalent of the instantaneous unit hydrograph. This work appeared before its time and was not paralleled or augmented until the research of Turner and Burdoin (1941) and Clark (1943).

In the intervening years, the emphasis was placed on better describing the storage effect of the watershed. Horton (1936, 1937) expressed the rate of channel flow in terms of the volume of channel storage remaining. Langbein (1938) recognized channel storage effects and attempted to account for them. Guthe and Owen (1941) employed relationships between baseflow, channel storage, and total discharge to solve the storage equation. Barrows (1942), Turner (1943), and Parsons (1944) determined relationships between storage and discharge from the recession limbs of hydrographs, assumed these relationships to be valid for the rising limbs, and developed inflow hydrographs. These studies were perhaps more practical than theoretical in nature, but aided in clarifying the possible channel storage effects.

Then followed the many classical conceptual models for the instantaneous unit hydrograph. All involved an inflow hydrograph, using a time-area diagram, a modification of it, or an approximation for it, and the routing of this hydrograph through some system of detention or storage reservoirs. Horton (1941) routed a triangular virtual inflow graph through a channel storage-discharge relationship. Turner and Burdoin (1941) routed the time-area-concentration curve through a reservoir of linear storage coefficient K , which was determined from the recession limb of existing hydrographs. Clark (1945) used a similar model, but obtained the storage coefficient from the point of contraflexure on the recession limb. Assuming the time-area diagram to be parabolic in shape, Edson (1951) routed it through a single linear reservoir to obtain an expression for the equivalent of the instantaneous unit hydrograph. Dooge (1955, 1956, 1957) found that the time-area diagram could be satisfactorily replaced by a triangle. It was routed through a linear reservoir whose storage coefficient remained constant for similar sized basins. O'Kelly (1955) approximated the time-area diagram with an isosceles triangle and routed it through a linear storage unit. As used by Turner and Burdoin (1941) and Edson (1951), the storage coefficient was estimated by the recession constant. The base of the inflow triangle was approximated from correlation with basin slope and the storage coefficient. Watkins (1956, 1963) also used the time-area diagram and a linear reservoir, but employed an empirical approach on the recession limb to obtain a storage coefficient.

Multiple storage units were introduced by Nash (1957) when he routed a time-area diagram through n linear reservoirs in series with equal storage coefficients. The coefficients were evaluated by the method of moments. Dooge (1959) followed with a model which resulted from adding partial curves obtained by routing a time-area diagram for the upper reach through n reservoirs, plus the area diagram for the next reach through $(n - 1)$ reservoirs and so on. Although the original model had reservoirs of unequal storage coefficients and channel reaches of different lengths, a solution was too difficult. Therefore, all reservoirs and all channels were equalized. Laurenson (1962, 1963) was the first to use nonlinear storage units. He routed the effective rainfall of the uppermost area through a concentrated nonlinear storage. The output of this storage was combined with the effective rainfall of the next sub-area and routed through a second nonlinear storage. The channel reaches were selected to be equal. Singh (1964) routed the time-area diagram through two reservoirs in series which had unequal properties. Diskin (1964) considered two series of reservoirs in parallel with all reservoirs in series identical. Kulandaiswamy (1964) developed a storage representation which could handle linear reservoirs in series and/or parallel.

A few rather individualistic conceptual models are of interest. These particular studies have also given consideration to the nonlinearity of the

watershed system. Amorocho (1963) represented a nonlinear response model by a functional series. The linearity of a system could be evaluated by the relative importance of linear and nonlinear terms. Although runs were made in a laboratory flume to investigate this model, methods of solution are still being studied. One type of solution that has been proposed involved Laplace transforms. Diskin (1965) revealed the application of this technique. Kulandaiswamy (1964) used a systems analysis approach and developed a general equation for a nonlinear reservoir. More recently, Harbaugh (1966) and Machmeier (1966) have developed models on the basis of spatially varied unsteady flow concepts. Harbaugh (1966) checked his mathematical model with runs on a laboratory catchment and with watershed data. Machmeier (1966) built up a drainage network of idealized stream channels and solved the model by digital computer. No consideration was given to stream junctions, and the model was not tested against field results. Of these models, the only two revealing strong nonlinear effects were those of Amorocho (1963) and Machmeier (1966).

Analog models

Computational analogs. In conjunction with the theoretical conceptual models, a number of analog models have been used. The similarity between conceptual equations and formulas describing other phenomena raised the question of whether a suitable model could be developed. Such models permitted reconstruction of the effective rainfall-runoff relationship, with opportunities for analysis of the significant factors involved and the synthesis of existing and design conditions. Paynter (1952) compared the drainage network to an admittance network, using the derivative of the admittance function to represent the instantaneous unit hydrograph. Appleby (1954) compared the equation of flow from a drainage network to the equation for the lineal flow of heat under similar conditions. A capillary flow model was used by Sagaware and Maruyama (1956) to generate watershed response. Robinson and Beyers (1962) used an electrical analog model based on the S. C. S equation to calculate runoff increments for average rainfall rates. Lienhard (1964) compared an equation for the dimensionless hydrograph with the Maxwell-Boltzmann molecular speed distribution. The drainage network has been recently compared to a salt diffusion model by Diskin (1965). Another electrical analog has been employed by Rosa (1966) to route runoff.

Physical laboratory models. Physical laboratory models for studying watershed response have been of the experimental flume type or of the iconic type. The former has been used extensively to study the nature of spatially varied unsteady overland flow, and the results of these investigations are being adapted for models such as that of Machmeier (1966). Iconic, or look-alike, models have recently become very popular for the analysis of significant watershed and storm parameters. Neither approach has yet yielded conclusive results.

The basic studies of Izzard and Augustine (1943), Izzard (1944), and Keulegan (1944) laid the

groundwork for research in spatially varied overland flow. Richey (1954), Behlke (1957), and Liggett (1959) further studied the mechanics of overland flow, including methods of solution; and Woo (1962), Amorocho (1963), Henderson and Wooding (1964), and Morgali (1965) began investigating the effect of rainfall parameters and surface conditions on overland flow flume studies.

Iconic models have been investigated by Chery (1966), Grace and Eagleson (1966), and Harbaugh (1966). Chery (1966) constructed a physical laboratory model which looked like a watershed, and used this model under rainfall simulation to study watershed response. Grace and Eagleson (1966) designed and tested a model. The modeling criteria were found to be valid if surface tension was negligible. Harbaugh (1966) used the Illinois watershed model to test his theory, and in particular to study the effect of raindrop impact as a roughness factor. All laboratory models have been impermeable and the modeling problems have not yet been completely mastered.

3. Analysis of the Total Response

Microscale studies. Microscale hydrologic studies have done much to clarify physical concepts of the rainfall-runoff relationship. However, to the present, researchers have had considerable difficulty extrapolating the approach to the macroscale. These studies may be considered to include small plot analyses, as well as urban hydrologic investigations.

Urban watershed response was initially considered by Horner and Flynt (1936). Their approach involved consideration of the loss functions and use of an urban runoff unitgraph. Horton (1936, 1938) carried on extensive small plot studies, primarily to advance his infiltration theory. However, his approach was also applied to runoff from small watersheds. Horner and Jens (1942) studied the rainfall-runoff relationship on an urban area in true microscale. Their methodology involved delineation of the areal distribution of rainfall, adjustment of infiltration values to antecedent conditions and the precipitation pattern, determination of the rate of production of excess rainfall, interception, depression storage, and infiltration out of surface detention, and translation of the mass surface runoff to hydrograph form. Hicks (1944) also proposed a complex design procedure for urban runoff hydrographs. The work of Izzard (1944) in overland flow, already noted in a previous section, has been used extensively by urban hydrologists. Watkins (1956) made an incremental determination of runoff by considering an impermeability factor, the area, and the mean rainfall contributing to that increment. The classic Chicago Hydrograph Method, presented by Tholin and Keifer (1960) and Keifer (1961), has proven to be one of the most practical urban hydrologic approaches. The general methodology has since been adopted by many cities in the U.S. Eagleson (1962) investigated unitgraph characteristics for sewered areas. The lag time, peak discharge, and the width of the unitgraph at some percentage of the maximum discharge were

related to sewers and basin characteristics. Viessman and Geyer (1962) also studied parking-lot runoff by regression analysis. These last two studies can scarcely be called microscale investigations, even though they were involved with small areas.

Watershed models. A total watershed response model necessitates determination of the storm yield as well as of the distribution of the runoff. It is the former determination that has plagued researchers throughout the years, whereas the latter problem has been considered extensively and discussed in a previous section. Many correlation-type studies have been applied to monthly and annual yield, but no such approach has given satisfactory storm yield estimates. A correlation approach taken by Folse (1929) has often been compared with the unitgraph method. However, Folse (1929) correlated daily yield with rainfall and runoff on previous days, vapor pressure, air temperature, and wind velocity. His methodology was entirely different from that of Sherman (1932), although each dealt with daily runoff values.

The initial studies regarding the total hydrograph involved graphical relationships between various parameters. Iwasaki (1934) obtained and applied approximate relationships between precipitation and the corresponding increments of groundwater and surface runoff.

Horton (1935) proposed a technique which involved use of a normal depletion curve, channel storage vs outflow relationships, surface detention vs runoff plots, initial storage values, and infiltration curves. A similar type of empirical approach was used by Snyder (1939). He studied graphically the variation of groundwater recharge with total runoff, the variation of groundwater discharge with storage, the variation of capillary water with precipitation minus the initial loss, the variation of capil-

lary water with groundwater storage, and the variation of the initial loss with groundwater storage and temperature. Linsley and Ackermann (1942) also considered many such graphs. The failure of most of these initial studies was due to the inability to sort out the significant parameters and to envisage a reasonable model of the watershed.

The most satisfactory practical methods for estimating storm yield have been presented by Kohler and Linsley (1951), and by Rainbird (1961). Both presented coaxial correlations. Kohler and Linsley (1951) considered basin recharge, antecedent precipitation, week of the year, storm duration, and storm rainfall in one correlation; and antecedent precipitation, storm duration, storm rainfall, and storm runoff in another. Rainbird (1961) investigated rainfall, moisture conditions, status of the catchment, season, duration, and peak runoff.

Watershed response models have been developed by the U. S. Weather Bureau [Kohler (1964)], Linsley and Crawford (1960), Watson and Body (1961), and Bell (1967). The first three models have been critically reviewed by Bell (1964). Each model employed storage units of various characteristics in order to monitor the moisture status of the watershed. The drying phase simulation involving evapotranspiration models, and the wetting phase simulation involving infiltration models varied from one approach to another depending on the particular evaporation or infiltration theories which were adopted. The conversion of rainfall excess to runoff used by Linsley and Crawford (1960) and by Bell (1967) was analogous to some of the theoretical conceptual models discussed previously; other watershed models relied upon the unitgraph method. None of these models has yet reached the point of being readily applied as an accepted working tool.

CHAPTER II

REVIEW OF RECENT METHODS OF DETERMINING WATERSHED RESPONSE

by Melvin Holland

The unit hydrograph is the most widely applied rainfall-runoff response model, but the widespread availability of high-speed digital computers has led to considerable investigation of extensions of the unit hydrograph approach and to development of more complex models of runoff response.

General "Black-Box" analysis. The unit hydrograph may be derived from the rainfall and runoff records after initial losses are subtracted from rainfall to give excess rainfall. Recognition that the unit hydrograph concept treats the watershed as a linear system has led to an application of techniques of linear systems analysis from electrical engineering. Electrical engineers have been considering general linear systems for many years and have developed an extensive literature on the subject. A least squares fit of the linear system unit impulse response function, which is analogous to the instantaneous unit hydrograph, based on given input (excess rainfall) and output (runoff) leads to the Wiener-Hopf equations (Restrepo and Eagleson, 1965). The solution of this set of simultaneous linear equations gives the ordinates of an optimal (in the least squares sense) unit impulse response function, but it may have some negative ordinates, impossible for a real hydrograph. To prevent the appearance of negative ordinates, the solution has been recast in the format of a linear programming problem (Eagleson, Mejia and March, 1965, 1966). Linear programming problems have been widely used in operations research and standard techniques are available for their solution.

To utilize the linear programming format, which results in only non-negative solution, the Wiener-Hopf equations are rewritten as inequalities and the objective function is the minimization of the sum of deviations from equality in the relations. Thus, a solution is obtained which is closest to equality of all solutions with ordinates that are either positive or zero.

The extension of the unit hydrograph to include nonlinear elements has been attempted in a variety of ways, some of which have been described above. Two methods which are related to the general linear system approach are the method of functionals and the method of decomposition analysis. General nonlinear formulations are more difficult than linear analysis because the latter has the form of the relationship specified and requires only the evaluation of parameters. There is an infinity of

forms that nonlinear relations may take and little progress is made unless the form of the relationship is specified beforehand.

The use of functionals is an extension of the instantaneous unit hydrograph, which has the mathematical designation convolution, in a manner analogous to the series expansion in terms of a polynomial (Amorocho and Orlob, 1961). In the series expansion, the linear form is

$$Y = a_0 + a_1 X$$

and the general form is

$$Y = a_0 + a_1 X + a_2 X^2 + \dots$$

The linear form of watershed response is

$$Y(t) = \int_{-\infty}^{\infty} u(t-\tau)X(\tau)d\tau$$

and the general form is

$$Y(t) = \sum_{n=1}^{\infty} \int_{-\infty}^{\infty} \dots \int_{-\infty}^{\infty} \left[u_n(t; \tau_1, \tau_2, \dots, \tau_n) \right. \\ \left. \prod_{j=1}^n X(\tau_j) \right] d\tau_1 d\tau_2 \dots d\tau_n$$

where $u_n(t; \tau_1, \tau_2, \dots, \tau_n)$ is the impulse response of the system and $X(\tau^n)$ is the input function. The analysis by functionals (the multiple integral is termed a "functional") does not have a well-developed mathematical analysis to draw on as linear systems analysis has, and progress has been slow on practical applications.

The method of decomposition analysis assumes that the nonlinear time-lag system may be represented by a series combination of linear time-lag systems and nonlinear no-time-lag systems (Jacoby, 1966). The linear time-lag systems use Laguerre systems with

$$Y_m(t) = \int_0^{\infty} \ell_{\mu}(t) X(t-\tau) d\tau$$

where the subscript m denotes the m th such system of a parallel set. The outputs of these systems are combined and used as input to a parallel set of polynomials whose output is compared to the output of the physical system to estimate parameter values. This system is less general than the

method of functionals because the forms of the component systems are specified, but this makes mathematical analysis more tractable.

Routing methods. Essentially all methods except the "black-box" analyses involve routing procedures. However, in the present discussion, a more limited meaning is attached to the term routing. The methods to be considered here involve routing flows through channel and/or storage elements. The routing of flows through linear reservoirs to establish the instantaneous unit hydrograph has already been mentioned. The routing equations themselves may be utilized to operate on a given flow to generate a specific hydrograph instead of a general unit hydrograph. Two approaches have been used in applying routing methods to watershed response. The first method divides the flow into overland and channel segments and applies the differential equations governing flow to the overland flow to establish the distributed input for the channel which is analyzed separately (Wooding, 1965). The second approach divides the watershed into isochronal segments based on time of flow to the outlet and, beginning at the farthest upstream section, routes inflow of one segment through storage and adds it to rainfall for the next lower section to establish the input for the latter segment (Laurenson, 1964).

Assuming that the overland flow occurs from a rectangular surface with distributed input,

$$\frac{\partial h}{\partial t} + \frac{\partial q}{\partial x} = v - f$$

where

- h is depth of flow,
- q is discharge per unit width,
- x is distance measured from the top of the rectangular surface,
- v is the rainfall input, and
- f is the loss to infiltration, evaporation, etc.

The channel flow relation is

$$\frac{\partial H}{\partial t} + \frac{\partial Q}{\partial x} = q_i$$

where

- H is depth of channel flow,
- Q is discharge,
- x is distance along the channel, and
- q_i is the overland flow for reach i at the channel bank.

For solution, these equations are converted to finite difference forms and appropriate boundary conditions are established, such as, h=0 for overland flow when t = 0 and x > 0 and h = 0 for t > 0 and x = 0. The equations may be solved by standard techniques such as the method of characteristics.

A routing method using less sophisticated mathematics consists of routing input to an element of the watershed area through a storage unit. The use of linear storage elements leads to a unit hydrograph model, but the storage can be made nonlinear for more generality. For a nonlinear reservoir, the storage-discharge relation has the form

$$S = K(q) \cdot q$$

where the storage coefficient K(q) depends on the outflow, q. The finite increment form of the continuity equation can be used to generate a routing equation of the form, for example, of the Muskingum routing equation, except that the coefficients are not constant but depend on the unknown outflow. The routing equation is solved iteratively by assuming a value for K(q), computing the current value of q and adjusting K for another iteration until the agreement between successive iterations is adequately close. Routing the time-distribution of input for an element of area establishes the outflow hydrograph, which is added to the rainfall input hydrograph for the next lower element to give the input for the latter.

Synthesis methods. The final type of mathematical model of watershed response to be discussed is the synthesis approach. It is a form of routing in which the elements are not sub-areas of the basin, but component processes of the hydrologic response. Using this approach, the rainfall may be divided among interception storage, infiltration and surface water. These may be further assigned to evapotranspiration, temporary storages and runoff processes (interflow, overland flow, and channel flow) (Boughton, 1966, Crawford and Linsley, 1966). The assignment for each subunit is developed on the basis of current knowledge of the physical process associated with it.

In the routing methods discussed previously, the routing elements could be considered sequentially. That is, the entire hydrograph for an upstream element could be computed before moving downstream. This is not possible for the synthesis models. The component processes are interdependent and the amount that leaves one type of storage frequently depends on how much is currently in the next component. Thus, all components are treated for one time unit before the next time unit is considered for any component.

The complexity of the synthesis models shows considerable variation. The unit hydrograph might be considered to be a one-process model, although this is not recommended. The other extreme of complexity in the breakdown and specification of model components is limited only by the existing knowledge of the physical processes involved in the response of the watershed to rainfall.

CHAPTER III

A CRITICAL APPRAISAL OF WATERSHED RESPONSE MODELS

by Trevor Dickinson

1. Accomplishments

Practice vs. Theory. An evaluation of any research attainments must be considered with regard to the purpose of the research. On one hand, the practical engineer is interested in objective methodology or tools to aid judgment in the solution of field problems. On the other hand, the theorist or scientist is usually concerned with increasing the knowledge about a particular system in order to attain a better understanding of the parameters involved and their interrelationships. It is important to consider both viewpoints for a critical appraisal.

Practical Viewpoint. With regard to the conversion of effective rainfall to runoff, it is evident that the most practical approach developed to date is that involving the unit hydrograph, the first method designed for the conversion. The methodology has been streamlined, and the technique has been found to be applicable to most watersheds. If several unitgraphs are determined for the same watershed from existing records, the peak discharge values may be expected to lie within plus or minus fifteen percent of the mean value 95% of the time [Coulter (1961), Dickinson (1963)]. The time to peak values will fall within similar limits. If the unitgraph is synthesized for an ungaged basin, the standard error of estimate may be more on the order of thirty to forty percent. Therefore, it should be recognized that the unit hydrograph approach does not yield precise estimates. Rather, it successfully gives the general order of magnitude and general distribution of the direct runoff hydrograph. For most practical problems, such estimation is sufficient.

The more elaborate storage type conceptual models are considerably more laborious to apply, and do not guarantee increased accuracy. In studies where these approaches have been compared with the unitgraph approach, it has been apparent that either approach yields equally as good, or as poor, an estimate of response. This type of conclusion, made by Laurenson (1962), Kulandaiswamy (1964), and Wu (1964), has not often been stated clearly by the researcher because of its negative reflection on his study. However, for both the researcher and the practicing engineer, it is important that this conclusion be realized.

With regard to the total watershed models, none is yet acceptable for storm response. All approaches yield fair estimates of the monthly or annual volume of runoff, but may be grossly in error

for storm runoff volumes. Investigations concerning the basic physical loss functions and parametric interactions on a watershed appear necessary before satisfactory working watershed models are achieved.

Theoretical Viewpoint. It has been suggested by Chow (1964) that the years since 1950 could be termed a period of theorization in hydrology. The review of literature bears this out. If the degree of theoretical sophistication is a measure of accomplishment, then the contributions have been many and significant. However, if the degree of increased understanding of the parameters and relationships involved is the yardstick, it is evident that there have been no large advances made regarding watershed response.

Because hydrologic data tend to be crude and inaccurate in nature, theorists have been loath to work with it. They have preferred to work entirely in terms of concepts and hypotheses. There have been few attempts to evaluate the quality of hydrometric work in order to deal with the data properly, and research has moved away from an understanding of the physical watershed. Since the theoretical approaches have failed either to yield increased accuracy in hydrologic estimates or to improve the understanding of the rainfall-runoff relationship, it appears inevitable that the hydrologic scientist will return to consideration of physical models and the physical processes on the watershed. It is interesting to note that at least two of the major academic institutions in the U. S. working in hydrology, and which have spent considerable time in theoretical conceptual models, are now considering physical modeling.

2. Suggestions for Research

Loss functions. As has been stated previously, knowledge regarding the loss functions experienced by rainfall falling on a watershed is meager, and what is known has not been used advantageously. Bell (1964, 1967) has suggested that there is considerably more information regarding evaporation, infiltration, and the soil moisture status in general than the hydrologist has been willing to use. Much more emphasis must be placed on these topics before storm yield can be properly predicted.

Both the time and space distributions of the loss functions require attention. The time distributions during a particular storm are not fully understood. The space distribution of these functions, as well as the space distribution of rainfall itself, and

the effect of these distributions on watershed response have not yet received any attention. Consideration of these aspects of rainfall-runoff relationships is essential for accurate estimation and understanding of runoff.

Nonlinearity. There seems to be little doubt that watershed response can be highly nonlinear in nature. However, it should be of considerable interest that such a nonlinear system tends to react somewhat linearly on occasion, particularly during flood occurrences. A number of questions arise. What are the significant factors which cause nonlinearity in response? Which of these nonlinear effects tends to approach linearity in certain ranges? Over what ranges, or when during the response process, can linear approximations be justifiably used?

A few thoughts in this regard may be noted. In studying the time of concentration on watersheds, Pilgrim (1966) noted that the time was a nonlinear function of peak discharge. However, in the range of discharges normally considered as flood hydrographs, the time remained virtually constant. In other words, in the range of flood interest, the nonlinear effect approached linearity. This very example may be due partially at least to the distribution of mean velocity in a stream versus discharge. At low discharges, the mean velocity may vary considerably with discharge. However, for higher discharges contained within banks, the mean velocity in the channel remains approximately constant. Therefore, in the range of flood discharges, the mean velocity, and hence the time of concentration, tend to be constant, and effects that are highly nonlinear in some parts of their ranges can be seen to approach linearity in the range usually considered for flood hydrographs.

The most significant nonlinear effects in the literature have been noted by those researchers

investigating either laboratory flume or conceptual unsteady flow models. Unsteady open channel flow introduces a nonlinear effect which is a function of the degree of unsteadiness in the flow regime. For example, an instantaneous or very short intense storm results in a steep flood wave in the channel, and leads to a large nonlinear effect during the rising limb, peak portion, and initial part of the falling limb of the hydrograph. This effect was observed by Amorocho (1963). However, a small percentage of floods occur from such storms. Usually, the duration is longer and the resulting flood wave is considerably flatter in nature. Therefore, large floods do not reflect the nonlinearity which might be expected from unsteady flow.

New runoff concepts. For several years, the concepts of surface flow, interflow, and baseflow have been accepted as adequately describing watershed response. These rather classical ideas are now being challenged by a number of scientists. Roche (1963) was one of the first to attack the generally accepted concept of interflow. He suggested that this flow was constituted by flow through vegetation and not laterally moving flow through the soil above the water table. However, on rural and agricultural watersheds, there is some question whether there is ever a significant amount of flow over the surface of the ground. Field workers have often observed flood peaks on rural watersheds, without having observed any real surface runoff. Therefore, are the present concepts of flow really meaningful? Further, is all work on surface or direct runoff entirely justified? The feasibility of some other views of the watershed and its manner of response should be and are likely to be considered in the near future in an attempt to come to an understanding of the processes involved.

CHAPTER IV

A DISCUSSION OF WATERSHED RESPONSE

by Melvin Holland

"Black-Box" Analysis. The major advantage of the black-box approach is that only the input (rainfall) and output (streamflow) records are required for applying the methods. A cost is associated with this feature in that the parameters of the resulting mathematical model cannot be related to specific watershed characteristics. This effectively limits the ability to transpose the model to unaged watersheds. Records of rainfall and runoff are required at the watershed which it is desired to investigate. In addition, the response of a watershed is not constant, so the parameters obtained from a joint rainfall-runoff record are estimates of the actual parameters and an extensive record may be required to establish confidence limits for the parameter estimates. At some point, it becomes more efficient to consider the distribution of runoff values instead of the model parameters in estimating runoff for design purposes. The point at which the direct utilization of the runoff record becomes more appropriate depends on the complexity of the procedure for estimating the parameter values and on the accuracy with which the model predicts runoff from given rainfall. The comparison between estimating model parameters and estimating the runoff distribution directly deserves further study. There are, of course, applications in which the frequency distribution of runoff is not sufficient, e. g., flood forecasting, but the trade-off between complexity of the model and accuracy of estimating parameters must be considered in any practical use of prediction models based on limited historical data.

Routing Methods. The direct use of the differential equations of flow to route the water through the catchment basin draws upon the success of these techniques in flood-routing and unsteady flow in channels. However, in the overland flow section, it is more difficult to establish simple boundary conditions for the flow segments and to assign values to the parameters of the equations.

Overland flow has been receiving additional attention in recent years in both theoretical and experimental research. As the factors involved in the overland process become more clearly understood, the routing methods based on the differential equations of flow will be more accurate and consistent in predicting the runoff. Another problem in the application of the routing techniques is the large number of areal flow units that may be required to describe a natural

catchment. The amount of time required for the routing calculations can be quite large even on the high-speed computers available today. In natural watersheds there is frequently considerable variation among the subareas, and this means both the parameters and the boundary conditions for the differential equations will vary significantly.

Synthesis Methods. Synthesis methods have two characteristics that are especially appealing to engineers. First, the water in a hydrologic unit is divided and routed according to what are believed to be the physical processes acting to convert rainfall to runoff. This means that physical significance may be clearly attached to individual parameters of the model and components of the model may be improved as additional knowledge gives better descriptions of the physical processes. The second feature is the flexibility of the model. Complex or simple models of component processes may be selected as required. The simplifying assumptions that are made can be related to the individual processes and direct adjustment made to model parameters. The effects of the assumptions are more easily related to the engineer's reasons for making the assumptions.

The synthesis models are limited by the lack of knowledge of the actual physical processes at work in forming the response of the watershed. The infiltration process is of primary significance in determining the runoff, but the descriptions of the process in current models are quite crude. In addition, the variability of natural conditions causes the same problems for parameter values here as for routing by differential equations. Finally, the comments made with reference to the number of parameters estimated with limited data in the "black-box" analysis apply also to the synthesis models. The more complex models of the component processes require many parameters to be estimated, and the confidence limits for the estimates may be extremely wide if the rainfall-runoff records are used to establish the parameter values. This can be partially offset for the synthesis model because investigations of the component processes yield independent data with which the parameters may be estimated. As more information is acquired from detailed studies of the component processes, less use will have to be made of the rainfall-runoff record in estimating model parameters, and the confidence limits for the model predictions can be narrowed.

CHAPTER V

BIBLIOGRAPHY OF PARAMETRIC HYDROLOGY

by W. T. Dickinson and M. E. Holland

1. Houk, I. E., 1921, Rainfall and runoff in the Miami Valley. Miami Conservancy District Tech. Rept., Pt. 8.

A separation between ground-water runoff and surface runoff was made by drawing on the hydrograph of total streamflow "lines representing the rate of ground-water flow---so as to pass through the low points only" of the hydrograph. The endeavor was to draw the line so that the increased flow of tiles immediately after a flood would be included in the surface run-off since such flow acts more nearly like surface flow.

2. Ross, C. N., 1921, The calculation of flood discharges by the use of a time contour plan. Trans. Inst. Engrs. (Austr.) Vol. 2:85-92.

The concept of time-contours was introduced in this article, leading to a time-area diagram. The author also showed how, and to what extent, it was possible for the greatest discharge from a given area to occur for a greater intensity of rainfall over part of the area than for a lesser intensity over the whole area. A numerical example was included.

3. Folse, J. A., 1929, A new method of estimating stream-flow based upon a new evaporation formula. Carnegie Institute of Washington, Publ. 400, Washington, D. C.

General formulas were derived which expressed the relationship between the daily flow of a perennial stream in a moist climate, on the one hand, and the meteorological elements of rainfall, snowfall, vapor-pressure, air temperature, and wind velocity observed on the watershed, on the other. The method was based on the correlation of the daily flow to the antecedent conditions, including rainfall and runoff on previous days, by a series of coefficients derived by least squares.

This was the first comprehensive study undertaken to compute daily runoff, and was one of the first articles to suggest the separate handling of "normal flow," a base flow, and "flood flow," a surface runoff. The formulas developed essentially gave storm yield, in terms of direct and total runoff.

4. Meinzer, O. E. and Stearns, N. D., 1929, A study of ground water in the Pomperang Basin, Conn. U. S. G. S. -W. S. P. 597, pp. 73-146.

The general method employed by Houk (1921) was used here. In addition, the curves showing ground-water runoff were brought up to meet the descending curve that showed total runoff.

5. Committee on Floods, 1930, Report of the committee on floods. Jour. Boston Soc. of Civil Engr., Vol. 17, No. 7:285-464.

This report has been credited with laying the foundation for storm and unit hydrograph studies. The following original concepts were presented: (1) the flood hydrograph resulting from a given storm on a

stream is the best key to the behavior of that stream with other storms, and also under different conditions of storage and pondage; (2) the physical features of the watershed are reflected in the flood hydrograph; (3) consideration of the flood hydrograph should take into account only the flood runoff (horizontal straight lines were used to represent and separate base flow); (4) the interval of time which it takes the water falling on the extreme part of the watershed to reach a given point under consideration is called the "concentration period" for the drainage area at that point; (5) the total flood period or base of the flood hydrograph is approximately constant for a given point on a stream; (6) the peak flood flow tends to vary directly with the total runoff; (7) a characteristic flood curve can be obtained by dividing the time by the square root of the drainage area and by dividing the quantity of flow both by the square root of the drainage area and the volume of runoff expressed in inches; (8) the hydrograph due to an instantaneous storm can provide an indication of watershed characteristics. Concepts (5) and (6) formed a portion of the basis for the unit hydrograph theory.

It is particularly interesting to note the thought of an instantaneous storm so early in the literature. This is the first reference to such a concept. Further, Sherman, recognized as the father of the unitgraph theory, was a member of this committee.

6. Sherman, L. K., 1932, Streamflow from rainfall by unitgraph method. Eng. News Record, Vol. 108:501-505.

This was Sherman's original paper outlining the concept of the unit hydrograph. His theory was based on the Report of the Boston Committee on Floods as can be seen from two of the basic postulates. The first specifying a constant base length was taken directly, and the second making all ordinates proportional to the volume of runoff was a generalization of the committee's findings. The contribution made by Sherman was to attach a definite duration to the storm producing the hydrograph. Indeed, the term "unit" in the title "unit hydrograph" referred to the duration yielding the unique unitgraph. Sherman further stipulated that the unitgraph should be based upon a uniform depth of rainfall over the entire watershed, the rain should be of high intensity and the duration of the storm must be less than the time of concentration of the watershed. He used the technique of Meinzer and Stearns (1929) for separating baseflow.

7. Sherman, L. K., 1932, The relation of hydrographs of runoff to size and character of drainage-basins. Trans. A. G. U., Vol. 13, Part 2:332-339.

It was the chief purpose of this paper to show how unitgraphs for similar basins could be computed from an original graph. The process is based upon the principle that the dimensions of similar areas vary as the square roots of the areas. Sherman also used the paper to stress the point that the unitgraph reflects all of the runoff effects due to the physical

characteristics of a given drainage basin excepting soil and seasonal variation of vegetation. The unit-graph was considered as the coefficient of runoff-rates for any particular basin.

8. Horton, R. E., 1933, The role of infiltration in the hydrologic cycle. Trans. A.G.U., Vol. 14, Part 2:446-460.

In discussing the role of infiltration, Horton considered the separation of base flow from surface runoff. He introduced the concept of the "normal depletion curve." It was shown that for a simple phreatic basin, the equation of the normal depletion curve is

$$q = q_0 e^{-ct}$$

where q is the ground water flow at time t , and t is the time elapsed from a date when flow was q_0 . This particular equation was derived by Horton in 1904 from theoretical considerations and applied to the depletion curves of several streams. If many phreatic sub-basins were present, the curve for the entire basin could be represented by

$$q = q_0 e^{-ct^n}$$

in which n is a constant. In general, the normal depletion curve could be represented by one or another of the above equations or by an equation similar to these but consisting of the sum of two exponent terms.

9. Leach, H. R., Cook, H. L., and Horton, R. E., 1933, Storm-flow prediction. Trans. A.G.U., Vol. 14, No. 2: 435-446.

A method was advanced for predicting, during the progress of a storm, the total amount of surface runoff which the storm would produce on a given drainage basin. The measured runoff taking place from a small area was used as an index of the runoff to be expected from the same storm on a part or the whole of the main drainage basin for which the prediction was made. The method depended on the fact that there was usually a close correspondence between the forms of hydrographs produced by a given storm in different streams within a given basin.

10. Iwasaki, T., 1934, A stream-flow study of the Tokyo water supply. Am. Water Works Assoc. Jour., Vol. 26: 163-175.

By a detailed study of the runoff from a mountainous drainage area, the author developed a standard depletion curve and also determined the approximate relation between precipitation and the increment of ground-water and surface runoff and was able to build up a hydrograph of total runoff.

11. Zoch, R. T., 1934, On the relation between rainfall and stream flow. Monthly Weather Review, Vol. 62, No. 9: 315-322.

Equations were developed for the relation between rainfall and the rate of runoff on the assumption that the rate of runoff at any given time was proportional to the rainfall remaining with the soil at that time. In other words, the storage s over the area was proportional to the runoff q . From this basic assumption,

$$\int_0^t i dt - \int_0^t q dt = cs$$

or

$$q = i(1 - e^{-t/c}) \text{ for } t \leq t_r$$

$$q = q_0 e^{-t'/c} \text{ for } t' = t - t_r \geq 0$$

where q is the rate of direct surface runoff, "/hr
 t is the time elapsed from the beginning of rainfall excess,

i is the intensity of rainfall excess, "/hr, for a duration t_r ,

q_0 is q at $t = t_r$

c is a constant depending on soil type, cover, and antecedent conditions.

Then,

$$Q = \int_0^{tv} q w dx$$

where w is the width of the contributing strip at a distance x from the outlet,

$t = x/v$, where v is the constant velocity of the moving water surface.

The equations for the hydrograph from a large rectangular drainage area were developed. In Zoch's integrations, it was assumed that the contributions of the elemental areas could be summed up independently provided they were lagged by their travel times. This paper was probably the first one to consider the runoff process in terms of the time of travel and the storage effect as two separate processes.

12. Bernard, M. M., 1935, An approach to determine streamflow. Trans. A.S.C.E., Vol. 100: 349-360.

The transition from rainfall to stream flow was accomplished through the medium of a "distribution graph," which was also found to be a function of watershed characteristics. The distribution graph is only a differently-dimensioned unit hydrograph, with the time scale expressed in days from the beginning of the storm and the flow scale in effective percentage of area contributing or percentage of the total runoff contributed each day. The author then graphically correlated the effective percentage, the day from the beginning of the storm, and w watershed character U , defined as:

$$U = \left(\frac{60 P}{L} \right)^{4 eg} F^{8 eg} \frac{S^{1.5 eg}}{1000^{2 eg}}$$

where P is a constant, depending on the shape of the area of the watershed and its manner of concentration,

L is the length in feet which water has to traverse in running from the most remote portion of the watershed to the outlet,

F is a constant depending on the shape and condition of the main flow channel,

S is the fall in feet per 1000 feet of main channel of flow,

e is a positive fractional exponent of t in the rainfall-intensity formula,

$$i = \frac{a T^n}{t^e}$$

where t is the duration of rain and T the recurrence interval,

$$g \text{ is } \frac{1}{4 - e}$$

The approach may be considered the first correlation of basin characteristics with parameters of the unit hydrograph. Bernard expressed the possibility of using the method for synthesizing hydrographs. It might also be noted that an average "recession curve" was used to separate base flow.

13. Horton, R. C., 1935, Surface runoff phenomena-Part I: Analysis of the hydrograph. Voorheesville, N. Y., Horton Hydrological Lab., Publ. 101, February.

The analysis and synthesis of flood hydrographs was discussed, on the basis of Horton's surface detention and infiltration theory. The steps of his analysis involved: (i) the separation of ground-water flows as determined from the normal depletion curve, (ii) determination of the relation between outflow rate and channel storage, and therefrom the graph of channel inflow, (iii) determination of infiltration capacity from the difference between rainfall and runoff for the interval from the beginning of rainfall excess to the end of direct surface runoff, (iv) the plotting of mass lines of rainfall, infiltration, and runoff, (v) plotting the mass supply line by subtracting the ordinates of mass infiltration from those of mass rainfall, (vi) plotting a graph of surface detention depth by taking the difference between the ordinates of mass supply and mass runoff, (vii) plotting a surface detention vs. outflow rate graph. If for a given area, the following information was known: normal depletion curve, channel storage - outflow relation, surface detention-runoff relation, initial storage, and infiltration capacity; then, a flood hydrograph could be synthesized by: (i) plotting a rainfall graph and mass curve, (ii) plotting a mass infiltration line and a mass supply line, (iii) determining the surface runoff and surface detention lines, (iv) applying the storage equation and the outflow rate - channel storage relation to obtain the hydrograph at some point downstream, (v) adding appropriate ground-water flows.

This publication was one of the first classical works of Horton. It acknowledged the effects of surface and channel storage and presented a graphical synthesis of flood hydrographs.

14. Bernard, M. M., 1936, Determination of flood flow by unit-hydrograph method. Article in U. S. G. S. - W. S. P. 771: 451-461.

The methodology was outlined for constructing a flood hydrograph, having available the distribution graph of the basin, a storm of known magnitude and areal distribution, and a knowledge of approximate relations between surface runoff and the pluviograph under accompanying seasonal and antecedent conditions. The author observed that no adaptable device similar to the unitgraph had been available for directly comparing, in the final terms of flood flow, the effect of placing a storm of a given pattern in various positions on the basin.

This article is included in U. S. G. S. - W. S. P. 772.

15. Folse, J. A., 1936, The Hayford method of estimating surface runoff versus the Sherman ("unit-graph") method. Trans. A. G. U., Vol. 17, Part 2: 306-309.

The author pointed out that the basic principles underlying the unitgraph method appeared first in his publication 400 (1929). The method of applying

the principles involved in his reference were more rigorous as well as more widely applicable than Sherman's graphical method, and the principle had been used since 1911 on the computations and studies involved in his publication. Folse reiterated that his equations infer that the surface-runoff to the stream is a linear function of the increase in storage above the ground surface. Also, the surface flow curve for any stream or its analytical expression, i. e., the Folse equation, is constant, but different streams have different characteristics.

16. Horner, W. W. and Flynt, F. L., 1936, Relation between rainfall and runoff from small urban areas. Trans. A. S. C. E., Vol. 101: 140-183.

The shape of the runoff unitgraph from small urban areas was derived from a study of the records of a few short rains of fairly uniform intensities and empirical equations were presented. For increasing values of q , the equation was,

$$q_a = q_m \left(\frac{t}{t_1} \right)^j$$

and for decreasing values of q , the equation was,

$$q_d = \frac{q_m}{K^{t-t_1}}$$

where q_a and q_d are the ascending and descending instantaneous values of the runoff rate q resulting from a rainfall of unit duration on a unit area,

q_m is the peak runoff rate,

t is the time from beginning of rainfall,

t_1 is the lag time between the centers of mass of the rainfall and runoff rate curves,

j and k are arbitrary constants determined by trial and error. (For stations considered, j varied from 1 to 2; k varied from 1.2 to 2)

By integration, the area under the runoff curve was found to be,

$$I = q_m \left[\frac{t}{j+1} + \frac{1}{1nk} \right]$$

If each of the ordinates of the 100% runoff curve for a given storm and location as computed by the unitgraph formula was multiplied by the runoff factor for that storm (i.e. total runoff divided by total rainfall), the resulting curve usually agreed fairly well with the measured runoff. The agreement was better for the larger storms and for the later parts of storms.

This study tended to verify the assumption of linearity in the unit hydrograph method when applied to small urban areas.

17. Horton, R. E., 1936, Natural stream channel-storage. Trans. A. G. U., Vol. 17, Part 2: 406-415.

The paper marked the first time that channel storage was recognized to play a part in determining the shape of a hydrograph. From an analysis of a number of records, it was observed that the rate of channel-storage out-flow could be expressed in terms of the volume of remaining channel-storage as,

$$q_s = K_s S_c^m$$

where q_s is the discharge,

S_c is the volume of channel storage,

K_s, M are the parameters pertaining to each particular case.

18. Horton, R. C., 1936, Hydrologic interrelations of water and soils. Proc. Soil Sci. Soc. of Am., Vol. 1: 401-437.

On the basis of Manning's equation, a relationship was developed for computing the rising side of the surface runoff graph from small plots of unit width having 75% turbulent flow in a thin sheet.

$$q_s = \sigma \tanh^2 \left[\frac{3}{2} \sqrt{\sigma K_s} t \right]$$

where q_s is the discharge in cfs,

σ is the rate of rainfall in excess of infiltration, inches per hr.,

t is the time from the beginning of supply in minutes,

K_s is a constant dependent upon drainage area characteristics, or $K_s = \frac{1020\sqrt{S}}{n l_o}$,

S is the surface slope,

n is the roughness coefficient,

l_o is the length of overland flow.

19. Hoyt, W. G. et al., 1936, Studies of relations of rainfall and runoff in the U.S., U.S.G.S. - W. S. P. 772.

A good review was given of the methods of baseflow separation used to date. It was suggested that "in the problem of separating ground-water runoff from surface runoff, it might be necessary to take into account such relations and flow characteristics as depletion curves, recession curves, recharge curves, unit hydrographs, infiltration and storage factors, together with the effect of meteorologic conditions."

20. Zoch, R. T., 1936, On the relation between rainfall and stream flow-II. Monthly Weather Review Vol. 64, No. 4:105-120.

The concept of the drainage area curve, or time-area-concentration diagram, was introduced and used to extend the original theory (Zoch, 1934) to irregularly-shaped drainage areas. This curve related the effective shape of the drainage area.

In terms of later conceptual models, this work was equivalent to the assumption of an instantaneous unit hydrograph obtained by routing the time-area-concentration curve through a single reservoir.

21. Horton, R. E., 1937, Natural stream channel-storage. Trans. A.G.U., Vol. 18, Part 2: 440-456.

This paper was a continuation of that by Horton (1936). The further topics of: (i) relation of channel-storage for rising and receding stages, (ii) channel outflow with constant ground-water inflow, and, (iii) depletion of channel storage during recession with constant ground-water inflow were considered.

22. Zoch, R. T., 1937, On the relation between rainfall and stream flow - III. Monthly Weather Review Vol. 65, No. 4: 135-147.

This article of the series (see Zoch, 1934 and 1936) considered the evaporation which takes place

after the rain has stopped, and its effect on stream flow. The rate of rainfall, the condition of the soil, and the velocity of the water were considered to be constant. Equations were presented which (1) showed the effect of evaporation on runoff, (2) gave the discharge from a rectangle when the effect of constant evaporation rate was considered, (3) gave the discharge from a drainage area of any shape where the rate of evaporation was any function of time, (4) considered the diurnal variation of rate of runoff. A few hypothetical hydrographs were computed revealing the magnitude of the effect of evaporation on the discharge.

23. Horton, R. E., 1938, The interpretation and application of runoff plot experiments with reference to soil erosion problems. Proc. Soil Sci. Soc. of Am., Vol. 3: 340-349.

An equation was developed that indicated the rate of overland flow to be expected from a uniform rate of rainfall-excess, assuming flow characteristics ranging from fully turbulent to laminar.

$$q_s = \sigma \tanh^M \frac{M+1}{M} (\sigma K_s)^{1/M} \frac{t}{60}$$

where q_s is the rate of overland flow at the lower end of an elemental strip, in cfs per acre,

σ is the rate of rainfall in excess of infiltration, inches per hr.,

M is an exponent dependent upon the type of overland flow,

K_s is a constant dependent upon drainage area characteristics,

t is the time from the beginning of supply, in minutes.

The equation was strictly rational for 75% turbulent flow (i. e., $M = 2$), and quasi-rational for other degrees of turbulence from 33% to 100%. The constant K_s involved slope, roughness and length of overland flow, and percentage of turbulence.

$$K_s = \frac{1020 \sqrt{S}}{I n L}$$

where S is the surface slope,

I is the factor of turbulence,

n is the coefficient of roughness,

L is the length of an elemental strip of turfed or paved surface in a direction parallel to the maximum slope.

M is 3.00 for laminar flow and 5/3 for fully turbulent flow.

$$I = \frac{3}{4} (3.0 - M)$$

If M were assumed to be 2.00,

$$q = \sigma \tanh^2 \left[0.922 t \left(\frac{\sigma}{nL} \right)^{0.50} S^{0.25} \right]$$

This paper was a more generalized approach than that given by Horton (1936).

24. Langbein, W. B., 1938, Some channel-storage studies and their application to the determination of infiltration. Trans. A.G.U., Vol. 19, Part 2: 435-445.

It was recognized that surface-runoff was obscured by channel storage effects. Attempts were

made to adjust hydrographs for these effects in order to compute the hydrograph of surface-inflow into the channel system.

25. McCarthy, G. T., 1938, The unit hydrograph and flood routing. Presented at Conference of North Atlantic Division, Corps of Engineers, June, 1938.

Unitgraph and topographic parameters were correlated, and the results were summarized in a figure in such a way as to permit an estimate of the unitgraph parameters for an ungaged drainage area. Three unitgraph parameters were selected, namely: peak discharge, lag-to-peak from beginning of rain, and total base time. The three predominant topographic characteristics were: size of area, slope of area-elevation graph [(1) plot area versus elevation equalled or exceeded; (2) planimeter the area between this graph and a horizontal line drawn through the minimum elevation of the watershed; (3) divide this area by half the square of the drainage area to get the average slope in ft/sq. mi.], and stream pattern expressed by the number of major streams [one-branch - a single stream drains 25%; two-branch - 2 branches drain at least 50%; three-branch - three branches drain 75%]. The basic data consisted of 6-hr. unitgraphs of 22 streams in Connecticut, ranging from 74 to 716 sq. mi.

This paper, out of print and difficult to locate, is quite accurately summarized by Johnstone and Cross (1949).

26. Pettis, C. R., 1938, Appraisal of unitgraph method of flood estimation. Civil Engineering, Vol. 8, No. 2: 114-115.

From a consideration of several unit hydrographs, taken from U. S. G. S. - W. S. P. 772 and a report of the Boston Society of Civil Engineers, involving some 15 rivers, it was determined that: (a) for all practical purposes, the fundamental linear assumption of the unitgraph is correct, (b) the main source of error in unit hydrographs is in the estimate of baseflow, (c) an individual unit hydrograph of less than 0.5 inches of runoff is not reliable, (d) an average distribution graph is fairly reliable.

27. Snyder, F. F., 1938, Synthetic unit graphs. Trans. A.G.U., Vol. 19, Part 2: 447-454.

The author correlated basin characteristics with peak flow, basin lag (i.e., time from the center of mass of rainfall excess to the peak), and total time base of the unitgraph. He presented for drainage areas of 10 to 10,000 sq. miles,

$$t_p = C_t (LL_c)^{0.3} \quad \text{in which } t_p = \text{basin lag in hours;}$$

$$A = \text{basin area, mi}^2$$

$$L = \text{length of the main stream from the divide to the outlet, miles.}$$

$$L_c = \text{distance from the outlet to the point on the main stream nearest to the centroid, miles.}$$

$$C_t \text{ is a coeff., 1.8 to 2.2 for Appalachian highlands}$$

$$q_p = \frac{640 C_p}{t_p} \quad q_p \text{ is peak discharge, cfs.}$$

$$C_p \text{ is a coeff., 0.56 to 0.69}$$

$$T = 3 + 3 \frac{t_p}{24} \quad t_r \text{ is unit duration of rainfall excess} = \frac{t_p}{5.5} \text{ hrs.}$$

$$t_{pR} = t_p + \frac{1}{4}(t_R - t_r)$$

$$q_{pR} = \frac{640 C_p}{t_{pR}}$$

$$t_{pR} = \text{basin lag for duration of effective rainfall equal to } t_R$$

$$T \text{ is time base in days}$$

$$q_{pR} \text{ is peak discharge of unitgraph of duration } t_R$$

The coefficients C_t and C_p were found to vary considerably for different regions.

28. Barnes, B. S., 1939, The structure of discharge - recession curves. Trans. A.G.U. Vol. 20: 721-725.

The concept of flow from three different sources was attributed to hydrographs in the Upper Mississippi Valley: surface-flow, storm-seepage, and base-flow. The equation,

$$Q_t = Q_o K^t$$

was adopted by the writer to represent the depletion curve, and was used by him to separate the base-flow and storm-seepage from the records.

This paper was one of the first to describe the concept of storm-seepage.

29. Brater, E. F., 1939, The unit hydrograph principle applied to small watershed. Papers of the A. S. C. E., 1191-1215. (Also Trans. A. S. C. E., Vol. 105: 1154-1178, 1940).

The preparation of unit hydrographs and distribution graphs for twenty-two small streams, 4.24 acres to 1876.7 acres, and a study of their relation to the corresponding rainfall and watershed characteristics served to reveal some of the natural phenomena involved in the runoff process and indicated the usefulness of the unitgraph principle. It was observed that the unitgraph peak was reduced as the watershed area increased, but no expression was derived. The method of baseflow separation involved a curve, convex upward, which passed through the start of rise of the hydrograph and the point where all flow is baseflow, and had a maximum ordinate which occurred near the end of overland flow or about midway between the peak of the hydrograph and the end of surface runoff.

The paper tended to fill the gap with respect to size to which the unitgraph principle is applicable, from the city block (Horner and Flynt, 1936) to areas of several hundred square miles.

30. Collins, W. T., 1939, Runoff distribution graphs from precipitation occurring in more than one time unit. Civil Engineering Vol. 9, No. 9: 559-561.

A trial-and-error method was advocated for computation of the distribution coefficients. First a constant loss, or infiltration, large enough to account for about half the total loss was subtracted from the precipitation of each period; then a percentage was applied to the remainder. The inches of runoff were determined and a distribution graph was estimated and used on all events except the largest. Discharges from the smaller runoff amounts and the baseflow were subtracted from the hydrograph and the residual was considered to be the distribution of discharge from the largest runoff amount. The coefficients of the two distributions were compared and the method repeated until satisfactory results were obtained.

This paper presented a lengthy trial-and-error procedure to better estimate the infiltration rates

during a storm rather than using a constant infiltration capacity.

31. Hertzler, R. A., 1939, Engineering aspects of the influence of forests on mountain streams. Civil Engineering, Vol. 9: 487-489.

The unitgraph method was investigated as a technique for analyzing runoff from small basins. The study of from 2 to 6 unitgraphs for each of 22 drainages revealed (a) for comparable forested areas, peak percentages of runoff decreased as drainage area increased, (b) the width of the bases of the distribution graphs increased with area, (c) the effects of vegetative cover were reflected in the peak percentage and time base. A straight-line method of baseflow separation was utilized.

This paper showed that the unitgraph principle afforded a sound method of investigating land-use-runoff relations on small drainage basins.

32. Morgan, R. and Hullinghorst, D. W., 1939, Unit hydrographs for gaged and ungaged watersheds. U.S. Eng. Office, Binghamton, N. Y. July.

The S-curve or S-hydrograph was defined as the hydrograph of runoff from a basin with continuous generation of runoff. It afforded a compact means for comparing the hydrograph characteristics for storms of different durations. Unitgraphs for storms of any effective length could be readily derived by placing two identical S-curves along one another, displacing them by a time interval equal to the length of the desired unitgraph storm, and subtracting the ordinates at corresponding times.

This is believed to be the original definition of the S-curve concept.

33. Snyder, F. F., 1939, A conception of runoff-phenomena. Trans. A. G. U. Vol. 20: 725-738.

The author considered a procedure for determining the amount and kind of runoff that occurred under various conditions which involved the variation of groundwater recharge with total runoff, the variation of groundwater storage with groundwater discharge, the variation of capillary water with precipitation minus the initial loss, the variation of capillary water with groundwater storage, and the variation of the initial loss with groundwater storage and temperature. These characteristic relationships were determined for an example watershed.

Normal groundwater depletion curves were obtained from segments of the hydrographs when there was no surface-runoff in the channels. An arbitrary procedure was used in separating groundwater and surface runoff. The recession was extended downward under the current rise in the hydrograph just as the groundwater flow would have decreased had no rain occurred. At a convenient interval near the time of peak flow, a straight line was drawn forward to meet the recession of the current rise at the point where surface runoff ceased.

34. Zoch, R. T., 1939, A mathematical synthesis of the flood-hydrograph. Trans. A. G. U. Vol. 20: 207-218.

A general discussion was presented of Zoch's approach to the subject, which was given in detail by Zoch (1934, 1936, 1937).

35. Barnes, B. S., 1940, Flood forecasting in the upper Mississippi Valley. Univ. of Iowa Studies, Studies in Engineering, Bull. 20, March.

A rather detailed account was given of the division of the recession curve into three or more exponential decay portions. Use was made of the unit hydrograph in the flood forecasting system, although there was no discussion of the problem of predicting time lag.

36. Clark, C. O., 1940, Discussion of "Analysis of runoff characteristics" by O. H. Meyer. Trans. A. S. C. E., Vol. 105: 128-131.

Attention was given to the two separate phases involved: storage and lag-time. The Muskingum method of flood routing was used to show correlation between Meyer's analysis and the familiar function of storage in the usual routing of floods.

37. Horner, W. W., 1940, The analysis of hydrologic data for small watersheds. U. S. D. A. - S. C. S. T. P. 30.

The purpose of the method of analysis was to facilitate the prediction of infiltration capacity values from data. The procedure consisted of an introduction and discussion of the hydrologic principles and factors involved in the analytical work, and the development of specific procedure for the production of infiltration capacity values.

38. Hoyt, W. G., 1940, Current technique in runoff analysis. University of Iowa Studies, Studies in Engineering, Bull. 20, March.

A very general discussion was presented with regard to the observation and analysis of hydrologic data. It was more a popular version than a scientific article.

39. Kirpich, Z. P., 1940, Time of concentration of small agricultural watersheds. Civil Engineering, Vol. 10, No. 6: 362.

The time of concentration, defined as the time required for a particle of water from the most remote part of the watershed to reach the outlet, for small agricultural watersheds ranging in size from one to 200 acres, was observed to be a function of a factor K , which varied directly with the length of travel and inversely with the square root of the slope.

The relationship can be shown to be of the form,

$$T_c = 0.00733 K_1^{0.775}$$

where

T_c is time of concentration in minutes,

$$K_1 = L^{3/2} / H_1^{1/2} = L / \sqrt{S_1}$$

where L is the length of travel in feet,

H_1 is the difference in elevation in feet between the remote point and the outlet,

$$S_1 = H_1 / L$$

or

$$T_c = 0.8087 K_2^{0.562}$$

where

$$K_2 = L / S_2 = L / \sqrt{H_2/A}$$

H_2 is the average height of the watershed above the outlet in feet,

A is the watershed area in square miles.

40. Laden, N. R., Reilly, T. L., and Minnotte, J. S., 1940, Synthetic unit hydrographs, distribution graphs, and flood routing in the upper Ohio River basin. Trans. A. G. U., Vol. 21: 649-659.

The study involved the development of distribution graphs for both gaged and ungaged watersheds in the upper Ohio River Basin. It was discovered that McCarthy's synthetic method yielded computed hydrographs with peaks lower than those observed. The method was also tedious and was developed for areas less than 800 square miles. Also, Snyder's method was limited by a wider range of the constants in the Ohio district, and by the unreliability of transposing the constants. In general, the method adopted resolved itself into a combination of the two methods and use of developed S-curves.

41. Langbein, W. B., 1940, Channel-storage and unit-hydrograph studies. Trans. A. G. U., Vol. 21: 620-627.

The author suggested that the lag between the center of mass of effective rainfall and the center of mass of direct runoff was the best definition of the lag-time and that it was a measure of the channel-storage of unit-hydrograph characteristics of a basin. It was also shown that the lag-interval could be employed to compare S-curves, by plotting discharge in percent of ultimate discharge versus time in percent of lag-interval. These dimensionless S-curves for areas ranging from 30 to 4,000 square miles agreed quite well.

From the S-curve, the discharge of a unit-graph was found to be,

$$q = S [\text{volume of runoff/lag-interval}]$$

where S is the slope of a chord of the S-curve over an interval equal to the duration of the period of effective rainfall;

or

$$q = S 646 / \text{lag}$$

where q is rate in second feet per square mile and lag is expressed in hours.

A notable contribution was made when consideration was given to the maximum slope of the S-curve, which was noted to be the maximum discharge following a one-inch rainstorm of negligible duration. This discharge, the peak of what is now known as the instantaneous hydrograph, was determined to be

$$\text{Peak discharge} = [770 / \text{lag-interval}] .$$

The concept of obtaining the ordinates of the instantaneous unitgraph by considering the slope of the S-curve has been more recently described by Chow (1961), and Henderson (1963).

42. Meyer, O. H., 1940, Analysis of runoff characteristics. Trans. A. S. C. E., Vol. 105: 83-100 (Also Proc. ASCE 64: 1769-86, 1938).

Consideration was given to the shape of the rising limb of the "concentration curve" of the basic hydrograph (that resulting from a storm of duration equal to the time of concentration) in terms of the

"histogram" of the drainage area (the time-area-concentration curve). Modifications of the rising limb for storms shorter than the time of concentration were discussed, and the recession limb was treated as an exponential decay. For transposing hydrographs to areas where no measurements were available, the time of concentration was considered to be proportional to the three-fourths power of the length, and a set of curves giving distribution percentages on successive days of runoff for different topographies was used. The groundwater curve and percentage of runoff were each considered to follow annual cycles, which were almost proportional. The superposition of storms was accomplished by the linear addition of the hydrographs resulting from horizontal blocks of the rainfall hyetograph rather than vertical blocks.

This paper gave an attempt to mathematically define the shape of the hydrograph in terms of the physical concept of channel storage. The approach was perhaps midway between those of Sherman and Zoch.

43. Sherman, L. K., 1940, The hydraulics of surface runoff. Civil Engineering Vol. 10, No. 3: 165-166.

The purpose of this paper was to test the correctness of the assumption that the ordinates of unit hydrographs are proportional to their respective volumes. A hypothetical drainage area was considered and hydrographs were computed by routing small finite increments of flow through given channel reaches. In the process of routing, time of transit was in accordance with Seddon's wave velocity, m , which was equal to the increment of discharge divided by the corresponding increment of cross-section area. The outflow from each lateral strip was then routed through the 100 feet of a detention reservoir whose outflow was represented by $q = 0.33 d^{3/2}$ where d is the depth. Two hydrographs, one from a heavy and another from a light rain, yielded ordinates which were proportional to their volumes.

Like Zoch's analysis, this one considered the runoff process in terms of the time of travel and the storage effect as two separate processes. However, Zoch's "detention reservoir" can be shown to be of the form, $q = cd$, rather than the above.

44. Sherman, L. K., 1940, Discussion of "The unit hydrograph principle applied to small watersheds," by E. F. Brater. A. S. C. E. Trans., Vol. 105: 1181-1183.

The effect of the pattern of effective rainfall on the unitgraph was noted here. A storm centered on the lower end of the basin gave a relatively high and early peak, and conversely, a storm centered at the upper part of the basin gave a lower peak rate of runoff.

Also, the opinion was expressed that many baseflow lines had shown too great an increase during the period of surface runoff. Many cases had been found in which the baseflow had been negative, due to bank storage of water by infiltration at overbank or high stream stages. This concept of negative baseflow was relatively new with this discussion.

45. Snyder, F. F., 1940, Discussion of "The unit hydrograph principle applied to small watersheds," by E. F. Brater. A. S. C. E. Trans., Vol. 105: 1179-1181.

Regarding separation of baseflow, Snyder believed it possible that for a short period of time the groundwater discharge might actually decrease at a greater rate following the occurrence of runoff than

before. At sometime near the occurrence of crest discharge the groundwater discharge would begin to increase and then probably follow a trend similar to that described by Brater.

This paper was one of the first to consider baseflow separation following the above-described pattern.

46. Guthe, O. E., and Owen, J. C., 1941, A proposed method for calculating stream-flow. *Trans. A. G. U.*, Vol. 22: 799-809.

Calculations were made on the basis of four-hour intervals, and time-contours were used for determining the time-lag between the occurrence of runoff and its effect on discharge at the outlet of the watershed. Charts showing the relationships of baseflow and channel storage to total discharge were evolved for the rapid solution of the storage equation. After an analysis of the hydrologic characteristics of the watershed and the establishment of a single initial value for groundwater storage, a synthetic hydrograph was constructed solely on the basis of rainfall data and losses.

47. Hathaway, G. A., 1941, Application of hydrology in flood control. *Proc. of Hydrology Conf.*, Penn. State College, July.

It was affirmed that the most practical method of estimating the regime of runoff in natural drainage basins less than a few thousand square miles in area involved an application of the unit hydrograph. A more rational approach consisted in estimating runoff from principal tributaries individually by the unitgraph method and combining the tributary flows by flood routing. A plot of unitgraphs peaks versus drainage area revealed the discharge to be approximately a function of the three quarter power of area, for basins larger than fifty square miles.

48. Horton, R. E., 1941, Virtual channel-inflow graphs. *Trans. A. G. U.*, Vol. 22: 811-819.

A triangular channel inflow graph was conceived as adequately describing the runoff from a watershed into the channel. This graph began at the beginning of channel outflow, exhibited a common point with the outflow graph at the maximum outflow, ended under the point of centreflexure on the recession side of the channel-outflow graph, and had an area equal to that of the outflow graph. This virtual inflow graph was therefore an approximation for the time-area-concentration curve routed to the channel. The graph encompassed watershed storage effects, but left out the channel storage and lag actions. It was noted that these latter two could be studied by analyzing the virtual inflow and actual outflow hydrographs. Actual values of channel storage were determined for some sample hydrographs and the inflow graphs were routed through these storage elements to obtain the outflow hydrographs.

49. Horton, R. E., 1941, Flood-crest reduction by channel-storage. *Trans. A. G. U.*, Vol. 22: 820-835.

It was shown how from an outflow graph, it is possible to determine the virtual channel-inflow graph and the channel-storage characteristics. The first phase had already been described by Horton in a previous article in the same journal. For the second phase, he developed the equation,

$$\frac{q_g}{I_g} = \rho \left(1 - \frac{S_g}{Q_s} \right)$$

where q_g is the maximum outflow rate,

I_g is the maximum inflow rate,

S_g is the maximum channel storage,

Q_s is the total flood volume, excluding baseflow

ρ is a parameter to be evaluated.

This equation could be applied to the determination of flood-crest reduction.

50. Hoyt, W. G., 1941, An outline of the runoff cycle. *Proc. of the Hydrology Conf.*, Penn. State College, July.

The hydrologic cycle was considered in five phases: (i) rainless period when stream-flow is maintained by outflow from natural subterranean storage; (ii) initial period of rain associated with an initial rise in streamflow; (iii) period of continuation of rain until all available natural storage has been utilized; (iv) period of continuation of rain after all available natural storage has been utilized; (v) post rain periods during which channel storage and surface retention have not become entirely depleted. Each phase was discussed in qualitative terms.

51. Hursh, C. R. and Brater, E. F., 1941, Separating storm-hydrographs from small drainage-areas into surface- and subsurface-flow. *Trans. A. G. U.*, Vol. 22: 863-870.

A study was made of a number of recession limbs of hydrographs from watersheds in the Coweeta Experimental Forest. It was concluded that the main peaks of the hydrographs were the result of channel precipitation routed to the outlet, and the lower portions of the recession curves were made up of subsurface and groundwater flow.

52. Smith, Waldo E., 1941, Period versus instantaneous distribution-coefficients. *Trans. A. G. U.*, Vol. 22: 851-854.

In order to handle a large mass of work involving the use of distribution-graphs, it was decided to use, not period-average distribution-coefficients, but rather instantaneous ones read from a plotting of the graph as a smooth curve at the dividing points between the successive periods. This method and the regular block distribution-graph approach were used and compared. The agreement was excellent except where no coefficient occurred near the crest. The conclusion was that either method could be used without sacrificing dependability.

53. Turner, H. M., and Burdoin, A. J., 1941, The flood hydrograph. *Jour. Bos. Soc. Civil Engrs.*, Vol. 28, No. 3: 232-256.

The runoff hydrograph was considered as the result of routing a time-area-concentration curve through a reservoir having a linear storage coefficient K derived from an analysis of the recession curve of the hydrograph. The inflow hydrograph was hypothesized from the time-area curve; the storage relationship was determined from recession limbs; and then the inflow was routed through the storage to obtain the instantaneous unitgraph. The method presented gave results that were almost identical with those obtained from Zoch's general equation if it was assumed that Zoch's storage factor applied to surface and channel storage only, baseflow having been omitted.

54. Barnes, B. S., 1942, Discussion of "Methods of predicting the runoff from rainfall" by R.K. Linsley and W. C. Ackermann. Trans. A.S.C.E. Vol. 107: 836-841.

The discussor proposed the name "interflow" to designate flows that were neither of groundwater nor of surface origin. It was suggested that the most objective manner for separating hydrographs involved the use of three recession constants: one for each of groundwater, interflow, and surface runoff.

55. Barrows, H. K., 1942, A study of valley-storage and its effect upon the flood-hydrograph. Trans. A.G.U., Vol. 23: 483-486.

The object of this paper was to study the effect of valley storage upon the form of the flood hydrograph. Using Horton's concept (1936) that a portion of the descending limb of the flood hydrograph represented flow from valley storage, a linear relationship between valley storage and discharge was determined. Assuming that this same storage-discharge relationship was experienced during the rising stages, a valley-storage inflow hydrograph was developed.

56. Commons, G. G., 1942, Flood hydrographs. Civil Engineering, Vol. 12, No. 10: 571-572.

A dimensionless flood hydrograph was developed by trial to cover typical floods for Texas conditions. This hydrograph was defined as the normal distribution of a given amount of runoff from a single storm, when the peak rate of flow was given. The base time was divided into 100 units, and the discharge axis into 60 units. The area under the curve was 1196.5 square units. The value of one unit of flow in cfs was determined by dividing the peak flow in cfs by 60 and one square unit in acre-feet was obtained by dividing the volume in acre-feet by 1196.5. The value of one unit of time in hours was the value of one square unit multiplied by twelve and divided by one unit of flow. That is

$$\frac{\text{Volume (acre-feet)}}{1196.5} \times \frac{60}{\text{Peak Flow (cfs)}} \times 12$$

= Value of one unit of time (hrs.)

It can be seen that if the base length of hydrographs at a station remain relatively constant, the peak flow is proportional to the volume. In other words, the linear assumption of the unitgraph theory is met. However, this method allows for different base lengths if practice yields such. The method has served as a useful practical tool, although it neither defines the distribution of runoff mathematically, nor describes the rainfall-runoff relationship.

57. Hicks, W. I., 1942, Discussion of "Surface runoff determination from rainfall without using coefficients" by W. W. Horner and S. W. Jens. Trans. A.S.C.E., Vol. 107: 1097-1102.

Formulas were developed for both average depth of detention and time of concentration as functions of slope, length of travel, and rate of supply, for tar and sand surfaces, tar and gravel surfaces, and a clipped sod surface. From experimental data, a curve was derived relating percentage of time of concentration and percentage of total storage or depth of detention. With formulas and corresponding charts, the alteration of the hydrograph of supply over a plane surface could be computed.

58. Horner, W. W. and Jens, S. W., 1942, Surface runoff determination from rainfall without using coefficients. Trans. A.S.C.E., Vol. 107: 1039-1075.

A methodology applicable to the determination of surface runoff from urban or large drainage areas was presented, involving (i) delineation of the precipitation pattern from which surface runoff was to be evaluated, (ii) choice of a basic infiltration capacity curve, (iii) adjustment of infiltration capacity values to antecedent conditions and precipitation pattern, (iv) determination of the rate of production of excess rainfall, (v) interception, depression storage, and infiltration out of surface detention, (vi) translation of mass surface runoff to hydrograph form. On the basis of the assumed flow-depth relationships,

$$Q = K \delta^2$$

where Q is the rate of flow, K is a constant, δ is the depth of flow,

$$V = 18.9 \delta^{0.67} S^{0.5} \text{ for imperious surfaces} \\ (n = 0.015),$$

$$V = 0.96 \delta S^{0.5} \text{ for turfed surfaces.}$$

The writers developed for pavements,

$$q = \sigma \tanh^{1.67} \left[\frac{1.60 (1,020)^{0.60} S^{0.30} \sigma^{0.60} t}{n^{0.60} l^{0.60} 60} \right]$$

where q is in inches per hour; σ is the rate of supply of excess rainfall, inches per hour; S is the absolute slope; l is the length of overland flow in feet; t is the time in minutes; n is the coefficient of roughness. This equation corresponds to one developed by Horton (1938) for turb conditions. To determine the hydrograph of overland flow, the q equations were applied to the rate of supply. The recession curves were adjusted to conform to experimental plot results where

$$q = 18 \delta_a$$

and δ_a is the average depth over the entire tributary area of the residual detention at that time.

The method essentially routes the effective rainfall histogram through a hydraulic overland flow model to obtain the outflow hydrograph. It is particularly applicable to urban and sewered areas, where the hydraulic model is most suitable.

59. Linsley, R. K. and Ackermann, W. C., 1942, Methods of predicting the runoff from rainfall. Trans. A.S.C.E. Vol. 107: 825-835.

New methods of streamflow separation were presented and consideration of vegetative and soil evapo-transpiration was given for the prediction of surface runoff from average rainfall. Recession curves for both surface and groundwater runoff, plots of the volume of groundwater discharge versus discharge, total runoff versus groundwater flow, groundwater runoff versus net peak groundwater flow, and duration of rainfall versus time to groundwater peak were developed for the Valley River at Tomothen, N. D., and subsequently utilized to separate flood hydrographs. The peak groundwater flow was observed to occur sometime after the flood peak, and the low point before this peak corresponded with the start of rise of the hydrograph. Surface loss was found to be proportional to rainfall, and panevaporation was used as an index of the field-moisture loss.

60. Merriam, C. F., 1942, Analysis of natural fluctuations in ground-water elevation. Trans. A.G.U., Vol. 23: 486-488.

The author suggested a ground-water index for several wells scattered over a wide area in an attempt to present hydrologists with a value that could be studied with regard to streamflow. However, as the first step in the procedure was to disregard those wells that did not "conform with the rest," the index was not a truly representative one. That is, it did not integrate all factors involved.

61. Smith, W. E., 1942, Discussion of "A study of valley-storage and its effect upon the flood hydrograph" by H. K. Barrows, Trans. A. G. U., Vol. 23: 486-488.

The chief criticism was that the storage-discharge relationships developed from the recession curve could not be applied to the rising phase. Further, the storage-discharge relationship was not linear but rather an exponential form. For the rising side, the storage for a given rate of flow was substantially higher than that on the curve developed for the falling limb.

62. Izzard, C. F. and M. T. Augustine, 1943, Preliminary report on analysis of runoff resulting from simulated rainfall on a paved plot. Trans. A. G. U., Vol. 24: 500-509.

This paper dealt with the preliminary results of analysis of runoff from a paved plot. The volume of detention was studied with regard to length of plot and discharge. The most important concept developed was the fact that detention on the rising limb, or at any time that rain was falling, was appreciably greater than detention required to maintain the same rate of flow on the recession limb after rainfall had ceased.

63. Linsley, R. K., 1943, Application of the synthetic unit-graph in the western mountain states. Trans. A. G. U., Vol. 24: 580-585.

This paper presented the results of an investigation to determine the necessary adjustments for Snyder's method in order to make them most effective for use in the basins of the Sierra Nevada and Coast Range of the U. S. It was found that basin-lag (time from center of mass of rainfall to runoff peak) was not a constant, and a standard unit of duration equal to the intercept on the time-to-peak axis was selected. The lag for a storm of short duration, t_{po} , was correlated with the product ($L_{ca} L$). Then the lag for a storm of duration t_r was written in terms of t_{po} and the effective rain. L_{ca} is distance from gaging station to center of area and L is basin length.

64. Snyder, F. F., 1943, Discussion of "Application of synthetic unit-graphs in the western mountain states" by R. K. Linsley. Trans. A. G. U. Vol. 24: 586-587.

Snyder's original premise that basin lag was constant had been altered to make basin lag a function of the duration of effective rainfall.

$$t_{pR} = t_p + (t_R - t_r)/4$$

Using this relationship, his and Linsley's work corresponded very closely. Only the coefficients varied from the one region to the other.

65. Turner, H. M., 1943, The flood-hydrograph and valley-storage. Trans. A. G. U., Vol. 24: 609-615.

This paper was essentially a discussion of that by Barrows (1942). The writer showed that the storage in the main river-channel, chiefly that near the station, was the chief factor in damping out the differences in the various floods. Then, the behavior of channel storage should permit without much error the application of the storage determined from the recession curve to the rising stage.

66. Hicks, W. I., 1944, A method of computing urban runoff. Trans. A. S. C. E. Vol. 109: 1217-1253.

Rainfall-runoff data for urban areas was analyzed in order to develop runoff hydrographs for areas of various sizes, development, and time of concentration. The peak runoff rate for a given storm pattern was found to be proportional to the volume of runoff resulting from the intense portion of the storm. The runoff hydrograph was the result of the travel and confluence of hydrographs from small units of area. A design procedure was outlined.

This was the first article to suggest the possibility of synthesizing urban runoff hydrographs. However, application of this technique was quite complex, particularly for storms with non-uniform rainfall-time relationships.

67. Horner, W. W., 1944, The drainage of airports. Ill. Univ. Eng. Exp. Sta. Circ. 49, 48 pp., Nov.

It was suggested that a real equation for the coefficient in the Rational Formula looks something like

$$C = \sqrt{\frac{K - K'}{K}} \cdot K'' \frac{A}{S}$$

where K , K' , and K'' are parameters of the equations of the rainfall curve, the infiltration capacity curve, and the hydraulic flow,

A is the area in acres,

S is the controlling slope.

Horner did not advocate the use of this equation, but considered it only to illustrate the complexity of the coefficient. His own approach involved the study of infiltration capacity and surface storage on small strips of different-surfaced areas, and the combination of runoff from these strips. The work was based on observed records from a number of existing airports.

Essentially the same paper was presented by:

Snyder, C. G., 1944, Additional arguments for modification of the rational formula for runoff from small agricultural areas. Trans. A. G. U., Vol. 25: 45-53.

68. Izzard, C. F., 1944, The surface-profile of overland flow. Trans. A. G. U., Vol. 25: 957-968.

Experimental data was presented applying Keulegran's equation of motion. Computed and actual water surface profiles were determined and compared for paved and turfed plots. Volumes of detention corresponded very favorably.

69. Jetter, K., 1944, Evaluation of runoff-distribution values from basic data and study of related drainage-area characteristics. Trans. A. G. U., Vol. 25: 990-1004.

Distribution graphs were derived from hydrographs resulting from storms having several periods of unequal rainfall. Infiltration was assumed to

occur at a constant rate and the method used to develop the distribution coefficients involved reversing the procedure normally used to constitute a flood hydrograph from the distribution graph. Then, interrelationships of the drainage-basin characteristics of length, slope, and areal distribution were shown graphically.

70. Keulegan, G. H., 1944, Spatially variable discharge over a sloping plane. *Trans. A.G.U.*, Vol. 25: 956-958.

The most general form of the dynamic equation of motion for a spatially variable discharge was developed. The frictional effect due to the mixing of the additive masses of the descending rain was acknowledged and equated to an equivalent shear stress acting at the water surface. By appropriate approximations and simplifications, an approximate solution of the runoff problem was given.

71. Lenz, A. T. and Sawyer, C. N., 1944, Estimation of stream-flow from alkalinity determinations. *Trans. A.G.U.*, Vol. 25: 1005-1009.

Alkalinity-discharge rating curves were developed for a number of streams in the Madison Lakes Region of Wisconsin. A logarithmic plotting showed that alkalinity was a function of discharge. There were two distinct parts to the curve: for flows greater than 0.8 cfs per square mile, the alkalinity decreased rapidly with increased runoff; for flows less than 0.8 cfs per square mile, the alkalinity decreased rapidly with increased runoff; for flows less than 0.8 cfs per square mile (i.e., ground-water runoff) the slope of the curve was very flat.

Although this article did not present it directly, the idea that alkalinity might be used as a basis for separating surface flow from groundwater flow is inferred by the results.

72. Parsons, W. J., 1944, Basin-storage method of developing flood-hydrographs from precipitation records. *Trans. A.G.U.*, Vol. 25: 9-14.

Separate storage-discharge relationships were determined for each of groundwater, subsurface flow, and surface runoff. Assuming that these relationships were also valid on the rising limb, they were used to determine hydrographs.

Whereas such an approach may be valid for some watersheds for the inflow hydrograph, the separate portions cannot be routed down a channel independently.

73. Clark, C. O., 1945, Storage and the unit hydrograph. *Trans. A.S.C.E.* Vol. 110: 1419-1446.

The instantaneous unit hydrograph was derived by routing the time-area-concentration curve through a linear storage reservoir. The time of concentration, T , and coefficient of proportionality, K , were parameters. T was defined as the time interval from the end of excess rainfall to the point on the hydrograph at which the ratio of the rate of decrease in discharge to total discharge was greatest; and K was the coefficient in the linear storage-discharge relation,

$$S_t = K Q$$

where S_t is the storage in the reservoir,

Q is the outflow.

K was evaluated from

$$K = -Q / \frac{dQ}{dt}$$

where Q is the rate of direct surface runoff at the point of contraflexure on the falling limb of the hydrograph. Further, the same time-area-concentration curve was routed through a second linear storage reservoir to obtain an instantaneous ground-water hydrograph. A K value of 200 was selected for this latter purpose. Then a combination of 70% of the surface unitgraph and 30% of the subsurface unitgraph provided a practical unitgraph for the area, which included both surface and subsurface flow.

The main difficulty of this approach is the selection of the point of contraflexure. This approach was the first to consider instantaneous rainfall, and therefore, the first instantaneous unit hydrograph theory.

74. Hathaway, G. A. and Cochran, A. L., 1945, Flood hydrographs. Chap. 5, Sec. II of "Engineering for Dams" by W. P. Creager, J. D. Justin, and J. Hinds. John Wiley and Sons, Inc., New York, U.S.A.

A discussion was presented regarding basic hydrologic analysis, subdivision of hydrographs using normal recession curves and ground-water depletion curves, unit hydrographs, and Snyder's synthetic unit-hydrograph relations and S-curve hydrographs. The approach was such that it would be useful for the practicing engineer.

75. Hathaway, G. A., 1945, Design of drainage facilities. *Trans. A.S.C.E.* Vol. 110: 697-733.

The basic equation for the rate of overland flow, as developed by Horton (1938), was adapted to airfield drainage problems by considering n -values of:

Smooth pavements	$n = 0.02$
Bare, packed soil, free of stone	$n = 0.10$
Poor grass cover, or rough bare surface	$n = 0.20$
Average grass cover	$n = 0.40$
Dense grass cover	$n = 0.80$

Series of overland flow curves were computed for paved and turfed areas assuming a 1% slope. The linear superposition hypothesis of the unit hydrograph method was used to develop the overland flow curve from a series of runoff hydrographs.

76. Holtan, H. N., 1945, Time-condensation in hydrograph-analysis. *Trans. A.G.U.* Vol. 26: 407-413.

A graphical technique for analysis of hydrographs and the determination of rates of runoff and infiltration associated with intermittent or fluctuating rainfall was given. It involved the adjusting of the time-scale of mass-curves of observed rainfall and observed runoff so as to provide straight or slightly curved lines. Interpretation of the analyses led to mass-curves of detention and retention.

77. Howland, W. E., 1945, Discussion of "Design of drainage facilities" by G. A. Hathaway. *Trans. A.S.C.E.*, Vol. 110: 738-743.

A mathematical method for the determination of a runoff hydrograph for a rain of limited duration was presented and compared with that of Hathaway. The basic differential equation was,

$$\sigma \cdot dT = K y^2 dT + \frac{2}{3} dy ,$$

the same one as used by Horton (1938). Whereas Hathaway applied the unit-hydrograph concept of superposition of storms, Howland did not, and the wide differences between the results reflected the failure of the linear superposition hypothesis.

78. Williams, H. M., 1945, Discussion of "Design of drainage facilities" by G. A. Hathaway. Trans. A. S. C. E. Vol. 110: 820-826.

The method of Hathaway did not provide for the determination of runoff from lengths of flow greater than 600 ft, where sheet flow no longer existed. In an effort to provide an extension to the design criteria, consideration was given to the development of a synthetic hydrograph procedure, similar to Snyder's. The following relations were determined:

$$t_p = 0.466 (L L_{cA})^{0.3}$$

or if $L_{cA} \approx \frac{L}{2}$,

$$t_p = 0.378 L^{0.6}$$

and

$$q_o = 37.5/t_p$$

where t_p is lag, in minutes,

L is length in miles,

L_{cA} is length of center of area, in miles,

q_o is the peak rate of discharge of the unit-graph, in cfs per acre.

A dimensionless unit hydrograph was adopted with the length of the recession equal to four times the rising side, or a total base length of $5(t_p + \frac{t_d}{2})$

where $t_d = t_p/5.5$, assumed value for the unit of duration of rainfall excess, in minutes.

For lower values of supply, the synthetic unit hydrograph produced a higher rate of peak discharge than Hathaway's approach.

79. Mitchell, W. D., 1948, Unit hydrographs in Illinois. U. S. G. S. and State of Illinois Dept. of Public Works and Bldgs.

The object of the study was to provide the techniques for performing the determination of the sequence, or time distribution, of runoff at a point of investigation. The unit hydrograph methodology was clearly presented, and the data and graphs for 58 stations in Illinois were included. Methods were also given for constructing synthetic unitgraphs wherein: (a) lag was known, (b) lag was computed from time to peak, (c) lag was computed from area.

80. Hoyt, W. G., 1949, The runoff cycle. Chapter XI, "Hydrology," edited by O. E. Meinzer, Dover Publ., New York, U. S. A.

The hydrologic cycle was considered in five phases, and each discussed. This article was essentially the same as Hoyt (1941).

81. Johnstone, D. and Cross, W. P., 1949, "Elements of applied hydrology." The Ronald Press Co., New York, U. S. A., 275 pp.

The unit hydrograph approach was considered under the topics of elementary unitgraph theory, unitgraphs from multiperiod storms, applications of the

unitgraph and limitations of unitgraph theory and practice. Also, the specific approaches of Bernard (1935), McCarthy (1938), Snyder (1938), and Clark (1945) were presented with examples of the methodology involved.

The book included a comprehensive summary of watershed response models considered to that date.

82. Linsley, R. L. Jr., Kohler, M. A., and Paulhus, J. L. H., 1949, "Applied Hydrology." McGraw-Hill Bk. Co., Inc., New York, U. S. A., 689 pp.

A section was devoted to hydrograph analysis, including: factors determining hydrograph shape and separation of hydrograph components. Also, the unit hydrograph was considered under: derivation from isolated storms and complex storms (after Zoch (1936) and Folse (1929)), the distribution graph (after Bernard (1935)), unitgraphs for various durations, synthetic unitgraphs (after Snyder (1938), and Linsley (1943)), transposition of unitgraphs, and dimensionless unitgraphs (after Commons (1942)).

83. Lucas, R. B., 1949, Unit graphs for ungaged drainage areas of Ohio. M. S. Thesis, Ohio State Univ.

Equations relating Clark's (1945) parameters of C and K to watershed parameters were studied with regard to 7 watersheds between 139 and 331 sq. mi. The relationships were:

$$C = \frac{4.7}{r^2} \left(\frac{L}{\sqrt{S}} \right)^{1/2} \text{ and } K = 1.65 + 8.46 \left(\frac{W}{R} \right)$$

where L is the length of the main channel, in miles; S is the equivalent uniform slope of the channel, ft. per mi.,

$$S = \left(\frac{\sum_{i=1}^n l_i \sqrt{S_i}}{\sum_{i=1}^n l_i} \right)^2 \text{ where } l_i \text{ and } S_i \text{ are the length and slope of reach } i; r \text{ is a dimensionless branching factor (i.e., ratio}$$

between the area under a curve depicting total area tributary to the main stream above a point, and the area under a curve depicting the total area that would be tributary if the stream were single-branched and the drainage basin were of uniform width); W is the width of the drainage area, A/L , in miles; R is the general overland slope, in ft. per mi. The branching factor played an insignificant role for basins less than 200 sq. mi. It was suggested that the C and K relationship be used with caution and only for obtaining initial estimates.

84. Sherman, L. K., 1949, The unit hydrograph method. Chapter XI E. "Hydrology," edited by O. E. Meinzer. Dover Publ., New York, U. S. A.

The basic hypotheses of the unit hydrograph and the distribution graph were delineated and their application was discussed.

85. Soong, Yu-Cheh, 1950, Influence of the location of storm runoff on shape of the unit hydrograph. M. S. Thesis, Dept. of Mechanics and Hydraulics, State Univ. Of Iowa, Feb.

The effect of areal distribution of rainfall excess on the shape of the unit hydrograph was studied with regard to one river basin in Iowa. The unitgraph was characterized by its mean time, and the standard

deviation about the mean time. The parameters relating to the areal distribution of rainfall excess were D , the weighted mean distance of the rainfall distribution; the weighted concentration coefficient; and the spread coefficient. The weighted mean distance reflected distance from the center of rainfall to the outlet; the concentration coefficient reflected the concentration of rainfall excess; and the spread coefficient also indicated the spread of the rainfall-excess distribution. For the Iowa River Basin, only the weighted mean distance and the concentration coefficient were used. The mean time of the unitgraph was related to the weighted mean distance as,

$$\bar{t} = C_1 + C_2 D^n; \text{ (where } C_1 \approx 1.25, \text{ and } C_2 \approx 1/30, n \approx 1$$

for \bar{t} in days and D in miles)

and the standard deviation of the unitgraph was a function of the weighted concentration coefficient. This was one of the first attempts to study the effect of areal distribution. For the particular basin studied, the position of the rainfall had a pronounced effect on the unitgraph.

86. Edson, C. G., 1951, Parameters for relating unit-hydrographs to watershed characteristics. *Trans. A.G.U.*, Vol. 32; 591-595.

The time-area distribution diagram and a conceptual reservoir were used to derive a two parameter equation for the instantaneous unit hydrograph. The time-area diagram was assumed to be of a parabolic distribution, such that

$$A \propto t^x, \quad x > 1$$

so that the discharge might become,

$$Q \propto t^x, \quad x > 1.$$

Considering the valley of the watershed to act as a reservoir, the discharge was known to decrease exponentially with time, or

$$Q \propto e^{-yt}, \quad y > 0.$$

Combining the above equations,

$$Q = B \cdot t^x \cdot e^{-yt}$$

By using the requirement that the total volume of flow was unity,

$$q_t = \frac{C \cdot y^{x+1} \cdot t^x \cdot e^{-yt}}{\Gamma(x+1)}$$

where q_t is the discharge in cfs per square mile,
 x is an exponent which reflects the shape of the basin, the channel network, and the channel slope,
 y is the recession constant or slope of the recession curve on semi-log paper,
 t is the time in days from the beginning of runoff,
 Γ denotes the gamma function.

87. Kohler, M. A. and Linsley R. K., 1951, Predicting the runoff from storm rainfall. U. S. Weather Bureau, Research Paper No. 34, 9 pp.

The prime purpose of the paper was to describe a coaxial graphical correlation analysis for (i) basin recharge, antecedent precipitation index, season or week of year, storm duration, and storm rainfall, and (ii) antecedent precipitation index, storm duration, storm precipitation, and storm runoff. The step of determining runoff volume was a necessary step before the hydrograph itself was determined. Further, a method of baseflow separation was employed involving (i) an extension of the recession existing prior to the storm to a point directly under the peak, and (ii) a straight line to intersect the hydrograph at a point n -days after the crest or after the end of runoff-producing rainfall.

88. Merriam, C. F., 1951, Evaluation of two elements affecting the characteristics of the recession curve. *Trans. A.G.U.*, Vol. 32; 597-600.

An entirely empirical approach was used to determine the recession constants for both groundwater and surface flow. The first step, to determine groundwater flow, involved an envelope curve representing the quantity of water in terms of thousands of cfs-days per foot of change in groundwater elevation expressed as a function of the groundwater elevation in feet. The envelope concept was used because errors introduced by percolation and direct drainage would always be in the same direction and the idea of a limit was valid. The first curve was then integrated with respect to elevation to yield the equivalent to the capacity of a reservoir. Further, an envelope curve was developed to relate groundwater elevation to the number of days to drop one foot. This curve was then combined with the first to establish the rate as a function of groundwater elevation. By integrating the second envelope curve with respect to elevation, a groundwater elevation curve was established and combined with the elevation versus flow curve to yield the groundwater hydrograph. The surface flow recession was obtained by plotting daily flows versus the flow of the previous day and again employing the envelope curve.

89. Watkins, L. H., 1951, Surface water drainage—a review of past research. *Jour. Instit. of Munic. Engrs.*, Vol. 78, No. 4:301-320.

A critical review of a number of investigations regarding surface water sewer design was presented. Although most attention was given to peak flow equations, mention was made of the unitgraph work of Horner and Flynt (1936), and the methods of developing run-off hydrographs from small areas or plots given by Horton (1938), Izzard, (1946), and the U. S. Corps of Engineers (1947). This review was conducted as the first step in the implementation of a program of research in surface water drainage problems.

90. Barnes, B. S., 1952, "Unitgraph Procedures." Denver, U. S. A., U. S. Bureau of Reclamation Hydrology Branch, 48 pp. November.

A discussion of methods that were in regular practice or experimental use by the Hydrology Branch was presented. The basic assumptions, as well as the application of the methodology were very ably given. Snyder's synthetic approach and the use of an "endless unitgraph" were included, the latter making use of an exponential recession for the unitgraph itself as well as for the groundwater curve. The entire presentation is in manual form, and as such, serves as an excellent handbook for basic unitgraph methodology.

91. Paynter, H. M., 1952, Methods and results from M. I. T. studies in unsteady flow. Jour. Boston Soc. of C. E., Vol. 39: 151-153.

The author compared an actual drainage network to an admittance network where admittance was the output, also called effect or response, divided by the input, also called cause or disturbance. Admittance is the reciprocal of impedance. Admittances can be adjusted so that an input corresponding to the rainfall excess applied to the admittance network yields a graph corresponding to the given direct surface-run-off hydrograph.

He was the first to mention using methods of system analysis for flood routing and for hydrograph study - and he mentioned the possibility of non-linear effects. He concluded that non-linear effects, influencing the admittance function, may be due to two causes: a seasonal effect and an order of magnitude of flood size effect. He suggested dealing with the non-linearities by constructing a family of admittance functions, all of which resemble one another qualitatively but which are quantitatively different. The IUG which is mathematically the derivative of the admittance function is, according to Paynter, not an invariable curve but one of a family of curves which vary according to the season and to the magnitude of flow involved.

92. Taylor, A. B. and Schwarz, H. E., 1952, Unit hydrograph lag and peak flow related to basin characteristics. Trans. A. G. U., Vol. 33: 235-246.

Unit-hydrograph lag and peak-flow values were empirically related to basin characteristics and to the duration of rainfall excess, where the lag was defined from the centroid of rainfall excess to the unitgraph peak. The most significant basin characteristics were found to be drainage area, length of longest watercourse, length to center of area, and equivalent main-stream slope defined as the slope of a uniform channel having the same length as the longest watercourse and an equal time of travel. Graphs of the correlation studies were given, a method for determining equivalent main-stream slope was presented, and a nomograph for the computation of synthetic unit hydrographs was included.

93. Warnock, R. G., 1952, A study of the relationship between watershed characteristics and distribution graph properties. M. S. Thesis, Dept. of Mechanics and Hydraulics, State Univ. of Iowa, Feb.

The purpose of the investigation was to study the relationship between the distribution graphs and the physical characteristics of watersheds. The analysis was on 33 basins in the Illinois area. The distribution graph parameters were the time to peak (center of mass of rain to peak flow), time-length of base, and the peak percentage (% of total runoff occurring in peak interval). The drainage basin characteristics used were the area, its shape (reflected in compactness coefficient - ratio of perimeter to the circumference of a circle of the same area), and the mean slope of the land. It was found that, for all three distribution-graph properties, the mean land slope was an important factor for areas below ≈ 200 sq. miles. Inclusion of the shape of the area improved the correlations for the length of base and the peak percentage. Graphical fits led to

$$t_p = K A^{0.89}$$

where

t_p is time to peak

A is area

$$K = 0.250 + 0.000403 S$$

S is land slope.

94. Jarocki, Walenty, 1953, "Hydrologic and Hydraulic computations of culverts and small bridges." Warszawa, Poland. National Science Foundation 160 pp. (Translation available thru Office of Technical Services, U. S. Dept. of Commerce, Washington 25, D. C.)

An excellent review was given of methods for computing maximum discharges. It parallels Chow's publication (1961), but considers primarily the foreign approaches.

1. Polish formulas - Ministry of Railroads, Ministry of Public Works, Ministry of Agriculture, Inkowski, Parenski, Rozanski, Rybozynski, Matkiewicz, Lambor, Malopolska, Debski.

2. Russian formulas - Nicolai, N. K. P. S., Dubelu, Soyuzdorproekl, Dubalch Rippar, Protodyakonov, Srilnyi, Dubelu, Kurdyumov, Boldakov, Karachevskii - Volk, Sokolovskii, Polyakov, Kocherin, Honigberg, Ogievskii.

3. European formulas - French, Italian, Kostlin, Pascher, Kressnik, Lauterburg, Swiss, Kreps.

4. German formulas - Saxony railroad, Hofmann, Weyrauch, Hofbauer, Specht, Bavarian, Love, Grassberger.

5. American formulas - Myers, Jarvis, Gutmann, Kuichling, Foster, Fuller, Horton.

95. Appleby, F. V., 1954, Runoff dynamics: a heat conduction analogue of storage flow in channel networks. Int. Assoc. Sci. Hydrology, General Assembly of Rome, Publ. 38: 338-348.

The general differential equation of flow from a drainage network for rising flood conditions to peak flow was developed as

$$v \bar{x} \frac{\delta^2 S}{\delta x^2} + \phi_r = \frac{\delta s}{\delta t}$$

where v is the outflow velocity,

\bar{x} is a mean length, such that the product of the outflow value of s and \bar{x} is the total storage S ,

s is the storage per unit length of channel,

S is the total storage,

ϕ_r is the runoff function, or units of rainfall over the area,

t is time,

x is distance along the channel.

It was recognized that the above equation had a close analogy to the equation for the lineal flow of heat under similar conditions, storage corresponding to temperature. Further, the recession

$$\frac{\delta^2 s}{\delta x^2} = q = - \frac{\delta s}{\delta t}$$

corresponded to cooling after the flux of heat had reached peak value. The product $v \bar{x}$ corresponded to diffusivity and v with conductivity. The principal two parameters of the system were v and K , the storage transit factor, which is a response

characteristic indicative to the mean time of concentration. To solve for ϕ_r demands an analog computer that readily allows trial values of ϕ_r to be tested.

96. Eaton, T. D., 1954, The derivation and synthesis of the unit hydrograph when rainfall records are inadequate. Jour. Inst. Engrs. (Australia) Vol. 25: 239-246.

A method for constructing synthetic unit hydrographs for catchments lacking adequate rainfall records was presented, based entirely on the work of C. O. Clark (1945). The virtual-inflow graph, introduced by Horton (1941), was also used as an aid. From an analysis of data for seven Tasmanian rivers, correlations were obtained between the catchment characteristics of area, length of channel, and branching factor, and the unitgraph parameters, C and K_1 , as used by Clark. The correlations inferred the equations:

$$C = 1.35 \left(L \times \frac{A^{0.50}}{R^{0.50}} \right)^{0.37}$$

and

$$\frac{q_p}{R} = 9.4 \left(L \times \frac{A^{0.50}}{R^{0.50}} \right)^{0.63}$$

where C is Clark's parameter for the base of the time-area curve,

L is a watershed length dimension,

A is basin area,

R is a branching factor,

q_p is the peak value of the unitgraph in cfs.

It was found that C correlated well with the basin characteristics but K was not necessarily so dependent because of storage that was not in apparent agreement with the catchment dimensions.

97. Fekete, P. H., 1954, Development of unit hydrographs under Australian conditions. Jour. Inst. Engrs. (Australia) Vol. 25: 234-238.

This paper first explained the unitgraph method, and then investigated the possibilities of its use in New South Wales under existing conditions of sparse hydrometric data. The author's method of obtaining unitgraphs was essentially that of W. T. Collins (1939). Also, it was accepted that the areal pattern of the rain did not need to be uniform. As long as the areal pattern of the storm to which the unitgraph was applied was similar to the one from which it was derived, no further allowance for the areal pattern was considered.

98. Richey, E. P., 1954, The fundamental hydraulics of overland flow. Ph. D. Dissertation, Stanford University.

A general differential equation was derived for the surface profile on a smooth plane. Solutions were obtained by numerical integration for laminar, laminar disrupted by rainfall impact, and turbulent flow regimes. The simplest equation, in which the depth was proportional to the cube root of the distance from the origin, conservatively approximated the volume of water contained in the overland flow profile for all phases of flow.

99. Seiichi, Sato, Kikkawa Hideo and Kimura Toshimitsu, 1954, On the study of runoff function method. Report of the Public Works Inst., Construction Ministry No. 87-2, January (in Japanese).

Analyze runoff phenomenon by runoff function $q = a t e^{-\alpha t}$, q = specific discharge caused by unit rainfall intensity. For duration $d\tau$ of rainfall

$$\int_0^{\infty} q dt = \int_0^{\infty} a t e^{-\alpha t} dt = 1 \cdot d\tau$$

so that $a = \alpha^2 \cdot d\tau$.

$$q = 0.2778 \alpha^2 t e^{-\alpha t} r_e d\tau$$

for q in ($m^3/sec/km^2$), r_e = effective rainfall intensity (mm/hr), t is time (hr.)

At peak flow $\frac{dq}{dt}$ is zero, from which

$$\alpha = \frac{1}{T}$$

where T is the lag time to the peak flow.

If rainfall r (mm/hr) continued for τ hours

$$q = 0.2778 \int_{t-\tau}^{\tau} \alpha^2 \cdot f \cdot r \cdot t e^{-\alpha t} dt = 0.2778 f \cdot r$$

$$\left[e^{-\alpha t'} (\alpha t' + 1) - e^{-\alpha t} (\alpha t + 1) \right]$$

where t = time since beginning of rainfall and $t' = t - \tau$ [f is a runoff coefficient $r_e = f \cdot r$]. Compare observed and computed hydrographs to determine f . Use q_o/q_c near peak for f .

If a segment of the real hydrograph does not agree with the computed one, the difference between the two can be plotted and an additional term can be added to the unit graph equation to give this segment. Then,

$$q = 0.2778 f_1 r \left[e^{-\alpha_1 t'} (\alpha_1 t' + 1) - e^{-\alpha_1 t} (\alpha_1 t + 1) \right] + 0.2778 f_2 r \left[e^{-\alpha_2 t'} (\alpha_2 t' + 1) - e^{-\alpha_2 t} (\alpha_2 t + 1) \right]$$

Additional terms can be added but one additional term should be sufficient according to authors.

100. Dooge, J. C. L., 1955, Discussion of "The employment of unit hydrographs to determine the flows of Irish arterial drainage channels," by J. J. O'Kelly. Proc. Inst. Civil Engrs., Vol. 4, Pt. 3: 436-442.

The writer suggested the use of mathematical relations rather than trial and error in finding the equivalent triangular virtual-inflow graph. He showed that if any inflow $I = f(t)$ is routed through a storage $S = KQ$, the outflow from storage is:

$$Q \cdot e^{t/k} = \frac{1}{K} \int I \cdot e^{t/K} \cdot dt + \text{constant}$$

Further, if the inflow were triangular, then at the point of maximum outflow:

$$\frac{Q_p}{I_p} = \frac{T - t_p}{t_2}$$

and

$$e^{t_p/K} + \frac{t_2}{t_1} = \left(1 + \frac{t_2}{t_1}\right) e^{t_1/K}$$

where Q_p is peak flow,
 t_p is time of rise,
 K is the storage constant,
 t_1 is the time of rise of the triangular inflow,
 I_p is the peak inflow,
 t_2 is the time of fall of inflow.

If Q_p , t_p , and K are known for a given unit hydrograph, the values of t_1 and t_2 for the equivalent triangular inflow graph are uniquely determined. The equation could be written:

$$\frac{Q_p \cdot t_p}{\text{constant}} = \frac{t_p}{T} \left(1 - \frac{t_p}{T}\right) \frac{T}{t_2}$$

and t_2/t_1 obtained for which the equations give identical values of T . Trial computations indicated that for values of t_p/K less than unity, the assumption that $t_1/t_2 = 1$ (i.e. an isosceles triangle) appeared to be quite justified.

101. O'Kelly, J. J., 1955, The employment of unit hydrographs to determine the flows of Irish arterial drainage channels. Proc. Inst. Civil Engrs., Vol. 4 365-401.

The time-area diagram was replaced by an isosceles triangle without loss of accuracy and with very considerable saving of labor, gain of flexibility, and convenience. The constant, K , for the linear storage model was derived from the falling leg of the hydrograph; and the time base of the time-area triangle, T , was approximated from the following table, assuming that the ratio K/T was a function of the slope.

Slope	Flat	Medium	Steep
K	1.17T	0.74T	0.52T
K/T	1.17	0.74	0.52

A basic isosceles triangle was routed through linear storage for K/T ratios from 0.25 to 2 to yield instantaneous unit hydrographs for the various ratios. Further, a diagram was presented to show the peak of the unit hydrograph in terms of the instantaneous peak, for unit periods in terms of T , for K/T ratios of 0.5, 1.0, and 2.0. These synthetic curves could be used to determine values of K and T for an experimentally derived unit hydrograph. The model values of the hydrograph peak, Q_p , the storage constant, K , and the base of the inflow triangle, T , were plotted against the statistical slope, S , of the ten catchments examined.

102. Snyder, W. M., 1955, Hydrograph analysis by the method of least squares. Proc. A. S. C. E., Vol. 81, Paper 793:1-25.

The hydrographs of ten storms were analyzed by a technique based on the method of least squares. Computation of the ordinates of each hydrograph were expressed as:

$$Y_5 = U_A \cdot RO_5 + U_B \cdot RO_4 + U_C \cdot RO_3 + U_D \cdot RO_2 + U_E \cdot RO_1$$

where

Y_5 is the ordinate at the end of 5 periods of runoff,

RO_1 to RO_5 are the amounts of runoff during successive periods,

U_A to U_E are the first 5 distribution coefficients.

By iterative solution the distribution coefficients of runoff were obtained simultaneously with estimates of the runoff volume.

103. Chow, V. T., 1956, Hydrologic studies of Floods in the United States. International Association of Scientific Hydrology Publication 42: 134-170.

Review of literature of floods: (1) Studies of flood-magnitude: Extreme-flood formulas (Myers, rational, etc.); experience curves (Q vs. A); infiltration analysis; rainfall-runoff relationship; hydro-meteorological studies (transposed storms, radar,). (2) Studies on magnitude and timing: Hydrograph analysis, flood routing, model routing. (3) Magnitude and frequency: frequency analysis (log-probability, Gumbel, etc.); regional frequency; rainfall-runoff relationship using frequency (rational, correlate climate and physiography); extension of flood frequency.

Organizations engaging in flood studies: Gov't. (federal and state), universities, public corporations and technical societies.

Applications: Design of structures, operations and forecasting, flood plain zoning, flood insurance, and economic analysis of flood projects.

104. Cuenod, M., 1956, Contribution a l'etude des crues. Determination de la relation dynamique entre les precipitation et le debit des cours d'eau au moyen du calcul a l'aide de suites. La Houille Blanche. Vol. 11: 391-404.

A theoretical determination of the S-curve was given and led to the conclusion that the hydrograph is characterized by:

$$q = p \cdot k_e (1 - e^{-t/T_q})$$

where q is the rate of direct surface runoff due to a continuous rainfall,

p is the rate of precipitation,

T_q is the characteristic time of the basin,

K_e is the coefficient of flow.

This relationship corresponds to that of Zoch (1934). Then a series solution was advanced for solving the convolution integral of the unit hydrograph and rainfall excess.

105. Dooge, J. C. I., 1956, Synthetic unit hydrographs based on triangular inflow. M. S. Thesis, Dept. of Mechanics and Hydraulics, State Univ. of Iowa, June.

The aim of the study was to examine the unit hydrograph principle, Clark's routing system, and O'Kelly's use of triangular inflow from the viewpoint of physical hydrology. It was shown that unit hydrograph properties were maintained under translation, multiplication by a constant, and addition or subtraction of two hydrographs of the same duration. Linear storage was proven to be a sufficient condition for the existence of a unit hydrograph. If it is assumed that (a) all storage in the catchment is a linear function of inflow and outflow rates, and (b) the ratio of the translation to the storage delay time is constant throughout the watershed, then a uniform rate of rainfall excess produces an outflow hydrograph with the properties of a unit hydrograph; and this hydrograph can be reproduced by translating all the flow to the outlet point, producing a time-area curve, and then routing the flow through a single element of linear storage. Then it was shown that the shape of the unit hydrograph can be reproduced by routing a triangular inflow with a time base T through an element of linear storage with a delay time K ; that for a catchment of standard size and conditions, the value of T and K is 8 hours; that, within wide limits, no adjustment for catchment shape is required; that the effect of area and slope can be allowed for by a simple power formula; that, when appreciable storage exists, the values of T and K can be adjusted. A quantitative measure of storage was developed. A practical procedure was also outlined for deriving a unitgraph of finite duration given only the topographical characteristics of the catchment.

106. Sugawara, M. and Maruyama, F. 1956, A method of prevision of the river discharge by means of a rainfall model. Int. Assoc. of Sci. Hyd. Symposia Darcy. Publ. 42: 71-76.

Unit hydrographs were developed from a mechanism involving a vessel containing and receiving fluid and a horizontal capillary outflow. Such a mechanism physically reproduced the relationship,

$$Y(t) = \int_0^t x(t-\tau) K(\tau) d\tau$$

where $K(\tau) = \lambda \cdot e^{-\lambda\tau}$

In other words, the basic unitgraph method was generated. Total flood hydrographs were also developed by combining a number of vessels, a number of inflows, and the resulting outflows. It was found that actual field results could be simulated, once the various coefficients in the model had been determined by trial and error.

107. Tojiro, Ishihara, Tanaka Yozo and Kanamaru Akira, 1956, On characteristics of unit hydrographs in Japan. Journ. of Japan Soc. of Civil Engrs. Vol. 41, No. 3, March 1956 (in Japanese).

1. Noted that one unit hydrograph is not suitable for all storms on basin. Rainfall intensity and other factors cause variations.

2. Proposed use of Horton equation for estimating precipitation losses.

$$f = f_c + (f_o - f_c) e^{-kt}$$

In practice f cannot be observed but total loss is estimated by

$$F = R - Q$$

where R is total rainfall and Q is total direct runoff

$$F = \int_0^T f \cdot dt = f_c T + \frac{f_o - f_c}{k} (1 - e^{-kT})$$

By plotting curves of constant number of days of no precipitation preceding given storm on graph of F against storm duration, T , authors estimate f_o , f_c and k .

Authors suggest this for estimating storm losses in generating data for unit hydrograph study.

108. Toshimitsu, Kimura, 1956, Study on a method of runoff analysis. Pamphlet edited by Numazu Constr. Office, Construction Ministry (in Japanese).

Estimate runoff by continuity and storage equations:

$$S_o = S_i + \int_{t_i}^t Q_r dt - \int_{t_i}^t Q dt$$

where Q_r = rainfall input

Q = outflow including baseflow

S_o = storage at any time

S_i = initial storage (at time t_i)

Storage components are effective storage (related to runoff) and non-effective (related to groundwater storage):

$$S_o - S_i = S_e + S_n = \int_{t_i}^t Q_r dt - \int_{t_i}^t Q dt$$

Let

$$S_n = \int_{t_i}^t Q_r dt - f \int_{t_i}^t Q_r dt \quad \begin{array}{l} f = \text{runoff coef.} \\ = \text{const. through-} \\ \text{out storm} \end{array}$$

Then

$$S_e = f \int_{t_i}^t Q_r dt - \int_{t_i}^t Q dt$$

If storage is assumed to be a single-valued function of discharge and equal values of Q are taken on rising and falling limbs of hydrograph, then

$$S_{e1} = f \int_{t_o}^{t_1} Q_r dt - \int_{t_o}^{t_1} Q dt$$

$$S_{e2} = \int_{t_0}^{t_2} Q_r dt - \int_{t_0}^{t_2} Q dt$$

By assumption $S_{e1} = S_{e2}$ so

$$f = \left[\int_{t_0}^{t_2} Q dt - \int_{t_0}^{t_1} Q dt \right] / \left[\int_{t_0}^{t_2} Q_r dt - \int_{t_0}^{t_1} Q_r dt \right]$$

$$= \int_{t_1}^{t_2} Q dt / \int_{t_1}^{t_2} Q_r dt$$

From continuity

$$\frac{\Delta S_e}{\Delta t} = f \bar{Q}_{r_i} - \bar{Q}_i \quad \text{bars indicate ave. over time } \Delta t$$

Storage function

$$S_e = \phi(Q)$$

Author noted that it is necessary to consider a time of concentration in the storage equation so that either precipitation must be shifted back in time or runoff shifted ahead in time. Let \bar{Q}_{r_i} be shifted to $\bar{Q}_{r_{i+\tau}}$.

Then, from continuity and storage equations,

$$\phi'(Q_i) \frac{\Delta Q_i}{\Delta t} = f \bar{Q}_{r_{i+\tau}} - \bar{Q}_i$$

and hence

$$Q_{i+\Delta t} = \frac{2\phi'(Q_i) - \Delta t}{2\phi'(Q_i) + \Delta t} Q_i + \frac{f \cdot \Delta t}{2\phi'(Q_i) + \Delta t} (\bar{Q}_{r_{i+\Delta t+\tau}} + \bar{Q}_{r_{i+\tau}})$$

Given rainfall rates for all time periods and runoff at one time period, subsequent runoffs are computed from this equation.

109. Villares, A. M., 1956, A method for the synthesis of unit hydrographs for small watersheds. M. S. Thesis, Univ. of Iowa.

For watersheds in the Illinois area, having areas less than 200 sq. mi., the unit hydrographs were described by an equation of the form

$$Q = Q_p \cdot e^{-a(\ln t/T_p)^2}$$

where "a" is a constant characterizing the recession limb; Q_p is the unitgraph peak; T_p is the time to peak. Further, it was shown that,

$$T_p \cdot Q_p \cdot e^{1/4a} \pi/a = 645$$

The time to peak can be estimated by,

$$T_p = C_p (sA)^{1/3} / S$$

where S is the slope; A is the area; C_p varies from 4 to 9 according to the type of drainage net. Also,

$$Q_p = C_t / T_p$$

where C_t is some function of slope and area.

110. Watkins, L. H., 1956, Rainfall and run-off. Jour. Inst. Munic. Engrs., Vol. 82, No. 8: 305-316.

A theoretical run-off curve was calculated from each rainfall curve, using a time-area diagram to relate the area contributing to the flow at the outfall to the time after the commencement of rainfall. The time of concentration was taken as the time from the commencement of rainfall to the peak rate of runoff. The method involved an incremental determination of runoff considering an impermeability factor, the area and the mean rainfall contributing to that increment. The impermeability factor was none other than the total percentage of runoff. This theoretical curve was then routed through a linear storage model with a variable storage factor that was empirically determined from the recession limb. If this limb were strictly exponential, the storage factor would be constant.

111. Yonezo, Nakayasu, 1956, On the synthetic unit graph in Japan. Report of VIIth Technical meeting of Construction Ministry (in Japanese).

Modification of synthetic unit graph proposed by Horner and Flynt.

$$Q_{\max} = \frac{1}{3.6} A \cdot R_o / (0.3 T_1 + T_{0.3})$$

$$\text{Rising limb: } Q_a / Q_{\max} = (t/T_1)^{2.4}$$

$$\text{Recession: } Q_d / Q_{\max} = 0.3 \frac{t-T_1}{T_{0.3}}, \quad Q_d / Q_{\max} > 0.3$$

$$Q_d / Q_{\max} = 0.3 \frac{t-T_1}{1.5 T_{0.3}}, \quad 0.3^2 < Q_d / Q_{\max} < 0.3$$

$$Q_d / Q_{\max} = 0.3 \frac{t-T_1}{2.0 T_{0.3}}, \quad Q_d / Q_{\max} < 0.3^2$$

where Q_{\max} = peak discharge (m^3/sec), Q_a = discharge on rising limb, Q_d = discharge on recession limb, R_o = unit rainfall intensity (mm), T_1 = time from beginning of unit rainfall to peak of unit graph, $T_{0.3}$ = time from peak to $Q = 0.3 Q_{\max}$ on recession, t = time from beginning of unit rainfall.

Unit time should be 0.5-1.0 t_g where t_g is time from center of unit rainfall to hydrograph peak. Estimating t_g :

$$t_g = 0.21 L^{0.7} \quad L < 15 \text{ km}$$

$$= 0.4 + 0.058L \quad L > 15 \text{ km}$$

L = maximum stream length.

112. Behlke, C. E., 1957, The mechanics of over-land flow. Ph. D. Dissertation, Stanford University.

Spatially variable laminar flow due to the effect of rainfall upon a smooth plane was considered. The basic assumptions were that: the shear stress produced by the plane was the same as that for uniform, steady, laminar flow of the same depth; the slope of the plane was small; the momentum and kinetic energy correction factors were unity; the flow everywhere was disturbed laminar; the plane was infinite in the downstream direction. The equation of motion was solved simultaneously with the continuity equation and the total derivatives for the depth and velocity of flow.

The rising limb, transition from the steady to unsteady flow recession, and the recession hydrograph were developed analytically by the method of characteristics. A 30 ft. overland flow laboratory model was used to obtain experimental results. The laboratory work revealed that for short planes and rainfall intensities up to four inches per hour, the shear stress assumption appeared valid. For longer lengths, a correction term was required. Also, small rainfall intensities on small slopes showed end condition to materially affect the upper end of the rising limb of the hydrograph, but to have no effect on the falling limb.

113. Butler, S. S., 1957, "Engineering hydrology." Prentice-Hall, Inc. New Jersey.

Good general coverage was given to the unit hydrograph method, the distribution graph and the S-hydrograph. The synthetic unit hydrographs of Snyder (1938) and Taylor and Schwarz (1952) were presented with sample calculations. The hydraulics of laminar overland flow was discussed with reference to the work of Izzard (1946).

114. Dooge, J. C. I., 1957, Discussion of "The form of the instantaneous unit hydrograph" by J. E. Nash. Int. Assoc. Sci. Hydrology General Assembly of Toronto Publ. 45: 120.

It was suggested that the assumption of a hydrograph produced by successive equal storages was not attractive from a physical viewpoint. Rather, the writer preferred the assumption of a triangular inflow routed through a linear storage, claiming it to be more reasonable, satisfactory empirically, and mathematically more convenient.

115. Mockus, V., 1957, Use of storm and watershed characteristics in synthetic hydrograph analysis and application. Paper presented at annual meeting of A.G.U., Sacramento, California, February.

A peak-rate equation was developed from the basis of a triangular hydrograph. It was,

$$q_p = \frac{484 A Q}{\frac{D}{2} + L}$$

where q_p is the peak discharge rate in cfs,

A is the drainage area in square miles,

Q is the volume of runoff in inches,

D is the duration of excess rainfall in hours,

L is the time lag, defined as the time from the centroid of excess rain to the runoff peak,

and it can be estimated by $L = 0.6T_c$, where T_c is time of concentration. A dimensionless hydrograph was also developed in terms of $\frac{q}{q_p}$ vs $\frac{t}{T_p}$, where T_p is time to peak. Triangular hydrographs from sub-watersheds were suggested for complex hydrographs.

This paper laid the foundation for the S. C. S. method.

116. Nash, J. E., 1957, The form of the instantaneous unit hydrograph. Int. Assoc. Sci. Hydrology General Assembly of Toronto. Publ. 45: 114-119.

An equation for the instantaneous unit hydrograph was developed from the assumption that any catchment could be replaced by a series of n reservoirs, each having the storage characteristic $s = kQ$,

with the outflow from one reservoir becoming the inflow to the next. The storage coefficients were all assumed to be equal. The outflow from the nth reservoir, for a unit inflow, was given by:

$$U = \frac{1}{k\Gamma(n)} e^{-t/k} (t/k)^{n-1}$$

The parameters, n and k, were evaluated by the method of moments. The first moment of the instantaneous unitgraph about the origin was equal to the difference between the first moments of the runoff hydrograph and the rainfall hydrograph; the second moment about the centroid was equal to the difference in the 2nd moments of the two curves about their respective centroids. The main difficulty with using the method of moments as a fitting procedure was that it gave most significance to the extremities of the distribution and the best fit was more in error near the peak than at the extremities.

117. U. S. Dept. of Agriculture, 1957, Hydrology guide for use in watershed planning. Soil Conservation Service, Nat. Engr. Handbook, Sec. 4, Hydrology Suppl. A., December.

This was essentially a reiteration of the paper by Mockus (1957). The triangular hydrograph approach was compared with the dimensionless hydrograph, and the latter in terms with the Commons hydrograph. Since the times to peak were matched, all methods compared very favorably. The triangular hydrographs from subwatersheds were also used to obtain composite hydrographs.

118. Kinji, Shinohara and Ueda Toshihiko, 1958, Runoff analysis in upstream basin of the Chikugo River. Report of Res. Inst. of Applied Dynamics, Kyushu Univ. No. 12 (in Japanese).

Examines relations given by Dr. Sato (1954) and others.

For short rainfall duration dT with uniform rate r (mm/hr.)

$$q = 0.2778 f \cdot r \alpha^2 t e^{-\alpha t} d\tau$$

For longer period τ

$$q = 0.2778 f \cdot r \left[e^{-\alpha t'} (\alpha t' + 1) - e^{-\alpha t} (\alpha t + 1) \right]$$

$$t' = t - \tau$$

Latter should be used to obtain expression of relation between α and lag time T

$$\frac{dq}{dt} \Big|_{t=T} = 0 \quad \text{peak flow}$$

Using second equation

$$T = \frac{\tau e^{a\tau}}{e^{a\tau} - 1}$$

If $\tau = 1$ hour

$$T = \frac{e^\alpha}{e^\alpha - 1}$$

Authors indicate peak rainfall r_p is related to lag time T.

119. Linsley, R. K., Jr., Kohler, M. A., and Paulhus, J. L. H., 1958, "Hydrology for Engineers". McGraw-Hill Book Company, Inc., New York, U.S.A. 340 pp.

Hydrographs of runoff were considered from the viewpoint of the unit hydrograph concept, derivation of the unit hydrograph from simple and complex storms, unit hydrographs for various duration, and synthetic unit hydrographs. W. M. Snyder's method of least squares and F. F. Snyder's, Taylor and Schwarz's, Linsley's, Common's, and Edson's synthetic and dimensionless approaches were noted and briefly considered.

120. Nash, J. E., 1958, Determining run-off from rainfall. Proc. Inst. Civ. Engrs., Vol. 10:163-184.

An excellent review was prepared for basin response models. The concept of "the linear operation" approach to unit hydrograph theory was particularly well outlined, and the instantaneous unit hydrograph was well described. It was shown that the rational method is identical with the unit hydrograph method provided an instantaneous unit hydrograph of constant ordinate over a period T_c is assumed.

Further, the time-area methods all assume that the derivative of the time-area concentration curve with respect to time furnishes the instantaneous unit hydrograph. More precisely, the ordinate at time t of the instantaneous unit hydrograph is equal to the derivative of the S-curve with respect to time at time t .

121. Tojiro, Ishihara and Takase Nobutada, 1958, Flood analysis of Yura River by runoff function, Trans. Japan Soc. of Civil Engineers. No. 57 (in Japanese).

Authors adopted runoff function of Pearson type, but modified to single exponential after secondary point of inflection.

$$q = a_1 t^n e^{-\alpha t} \quad q = \text{specific discharge}$$

$$\int_0^{\infty} q dt = \int_0^{\infty} a_1 t^n e^{-\alpha t} dt = 1 d\tau,$$

by continuity, for unit effective rainfall for $d\tau$ hours. Eliminating a_1 gives

$$q = \frac{0.2778 \alpha^{n+1}}{\Gamma(n+1)} t^n e^{-\alpha t} d\tau$$

q in ($m^3/\text{sec}/\text{km}^2$), rainfall (unity) in (mm/hr) and t in hr. Time to peak is $t_m = \frac{n}{\alpha}$, so

$$q_m = \frac{0.2778 \alpha^{n+1}}{\Gamma(n+1) e^n t_m^n} d\tau$$

For uniform rainfall for τ_0 hours

$$q = \frac{0.2778 \alpha^{n+1}}{\Gamma(n+1)} \int_0^{\tau_0} (t - \tau) e^{-\alpha(t-\tau)} d\tau \quad t > T_0$$

An approximation to this equation is

$$q = \frac{0.2778 \alpha^{n+1}}{\Gamma(n+1)} t^n e^{-\alpha t} \tau_0$$

This gives a curve shifted in time $\tau_0/2$ behind integral and with this phase shift correction is used as approximation of integral. Setting $d\tau = \tau_0$ in eq. (4) and letting $q_m = Q_m/A$, n is determined. Authors use $q = q_0 e^{-\alpha t}$ after secondary inflection

122. Barnes, B. S., 1959, Consistency in unitgraphs. Proc. A. S. C. E., Vol. 85 HY8: 39-61.

This paper undertook a re-appraisal of the common assumptions of the unit hydrograph, and presented detailed steps to be followed to derive unitgraphs from compound hydrographs. The flood hydrographs were separated and smoothed by the use of logarithmic plottings. The ordinates of the hydrograph for unit intervals were expressed in terms of the unitgraph ordinates as,

$$Q_1 = U_1 R_1$$

$$Q_2 = U_2 R_1 + U_1 R_2$$

$$Q_3 = U_3 R_1 + U_2 R_1 + U_1 R_3$$

where the R-values are coefficients to be estimated. Snyder (1955) had solved this set of equations by least squares; Barnes solved it by "progressive addition." Trial values of R were first set up, having their sum equivalent to the volume of the compound event. Then the U-values were determined one by one, and plotted, the R-values being adjusted in order to maintain a smooth unitgraph.

123. Dooge, J. C. I., 1959, A general theory of the unit hydrograph. Jour. Geoph. Res. Vol. 64, No. 2: 241-256.

The concept of linear channels and linear reservoirs was introduced, such that the translation effects were due solely to linear channels and the storage effects solely to linear reservoirs. The model was obtained as a result of adding the partial curves obtained by routing a time-area diagram for the upper reach of the basin through N reservoirs, plus the area diagram for the next reach routed through (N-1) reservoirs and so on. Originally, the reservoirs were not identical and the reaches between them were not of equal length. A general solution to the model was presented for identical reservoirs, equally spaced:

$$u_t = \frac{1}{T} \int_0^{t/k} P(m, n-1) \omega(\tau') dm$$

where T is the maximum translation time,

t is the time elapsed from the occurrence of the instantaneous unit rainfall excess,

$P(m, n-1)$ is the Poisson distribution function,

$m\theta = (t-\tau)/K$

τ is a variable translation time,

K is the delay time due to linear reservoirs, i. e. storage coefficient,

$n(\tau)$ is the number of linear reservoirs downstream of τ ,

$\omega(\tau')$ is the ordinate of the dimensionless time-area curve at time τ .

124. Hickok, R. B., Keppel, R. V., Rafferty, B. R., 1959, Hydrograph synthesis for small arid-land watersheds. *Agricultural Engineering* Vol. 40:608-611.

This paper presented a method of hydrograph synthesis developed especially for small arid land watersheds. It involved (a) estimation of a characteristic lag time from readily determined watershed parameters, (b) use of the lag time to predict the hydrograph peak for an assumed total volume of runoff, (c) synthesizing the entire hydrograph using the lag time, estimated peak, and standard dimensionless hydrograph. The method was based on 14 watersheds ranging in size from 11 to 790 acres.

The lag time was defined as the time from the center of mass of intense rainfall to the resulting peak of the hydrograph. For reasonably homogeneous semi-arid rangeland watersheds up to about 1000 acres in area,

$$T_L = K_1 \left[\frac{A^{0.3}}{S_a \sqrt{DD}} \right]^{0.61}$$

where T_L is lag time,

A is area,

S_a is average landslope,

DD is drainage density, or length of channel per unit area.

For watersheds differing widely in physiographic characteristics in some major portion of the area from the rest of the watershed,

$$T_L = K_2 \left[\frac{\sqrt{L_{sa} + W_{sa}}}{S_{sa} DD} \right]^{0.65}$$

where L_{sa} is length from outlet to center of gravity,

W_{sa} is average width,

S_{sa} is average landslope.

Then,

$$\frac{q_p}{V} = \frac{K_3}{T_L}$$

where q_p is peak rate of runoff,

V is total runoff volume,

T_L is lag time as above.

A generalized dimensionless hydrograph and mass curve were developed in terms of $\frac{q}{q_p}$ and $\frac{T}{T_L}$

125. Liggett, J. A., 1959, Unsteady open channel flow with lateral inflow. Ph. D. Dissertation, Stanford University.

A partly approximate, partly exact solution was evolved for unsteady flow with lateral inflow in the ideal case of a long, wide channel of constant slope. The properties of hyperbolic partial differential equations and the theory of characteristics were used to reduce the equations to ordinary differential equation in a portion of the problem. In other zones,

approximations were made which were based on the exact solution. A general, semigraphical method was given for the computation of steady state profile curves for all types of flow. The unsteady problem was considered under subcritical and supercritical flow headings.

126. Morris, W. V., 1959, Conversion of storm rainfall to runoff. National Research Council, First Canadian Hydrology Symposium, Ottawa, November.

The direct method of deriving a unitgraph, Clark's method, and Snyder's method were described in detail and applied.

127. Nash, J. E., 1959, Systematic determination of unit hydrograph parameters. *Jour. Geoph. Res.*, Vol. 64, No. 1: 111-115.

The number of degrees of freedom which are useful to maintain in the form of the instantaneous unit hydrograph were shown to be limited by the number of significant independent correlations with the catchment characteristics. The moments of the IUH were suggested as a series of parameters of the response for which correlations could be sought. A simple method of obtaining these moments was solved, Nash (1958), and a method of choosing between several two-parameter forms was demonstrated.

128. U.S. Army Corps of Engineers, 1959, Flood hydrograph analyses and computations. *Engineering and Design Manual, EM 1110-2-1405*, U.S. Govt. Printing Office, August.

The methodology of separating storm hydrographs, preparing unitgraphs, and deriving Snyder's synthetic unitgraph was clearly presented.

129. Wisler, C. O., and Brater, E. F., 1959, *Hydrology*. 2nd edition. John Wiley and Sons, Inc., New York, U.S.A. 408 pp.

The unit hydrograph approach was outlined and the equation presented by Horton (1938) for the rising limb of hydrographs from small plots was noted. The infiltration work of Horton, and concepts of surface detention and storage were given considerable attention.

130. Befani, A. N., 1960, Principles of the theory of processes of surface and underground runoff. *International Association of Scientific Hydrology Publication 51: 594-596*.

Runoff equations: (1) Surface runoff (creation phase),

$$(n+1) Cy^n \frac{\partial y}{\partial x} + \frac{\partial y}{\partial t} = h_t$$

(2) Surface runoff (depletion phase),

$$(n+1) Cy^n \frac{\partial y}{\partial x} + \frac{\partial y}{\partial t} = -K_{tw}$$

(3) Elementary streamflow runoff,

$$\frac{\partial Q}{\partial x} + \frac{\partial w}{\partial t} = Q'_t$$

(4) Flood runoff along river systems,

$$\frac{\partial Q}{\partial x} + \frac{\partial w}{\partial t} = Q'_{xt}$$

(5) Underground runoff from aquifer,

$$kJ \frac{\partial H}{\partial x} - k \left(\frac{\partial H}{\partial x} \right)^2 - kH \frac{\partial^2 H}{\partial x^2} + \delta \frac{\partial H}{\partial t} = \bar{K}_n - K_{n+1}$$

y = depth of surface streamlet related to whole width of slope, H = depth of groundwater stream, w = section area, Q = point discharge at time t, J = slope angle of underlying surface, n = roughness exponent, h_t = rate water creation (rainfall-losses), K_{tw} = rate of infiltration during depletion related to whole area of slope, Q_t' and Q_{xt}' = discharge of local inflow per unit of length of streamflow considered, δ = water delivery of nth aquifer in parts of unity, k = filtration coefficient of aquifer, K_n and K_{n+1} = rates of infiltration into aquifer and underlying strata.

Eq. (1) is integrated in general, h_t being an arbitrary function of time.

Eq. (2) is integrated for special cases, depending on effects of water table on infiltration.

Eq. (4) can be solved but is complex so simpler systems are solved and adjusted to give approximate solutions.

Eq. (5) is similarly treated.

[Note: solutions are not shown or described in detail]

131. Chen, M. C., 1960, Effect of watershed characteristics on peak rates of runoff in eastern Colorado. M. S. Thesis, C. S. U.

A study of watershed characteristics in an area in eastern Colorado was made in order to develop a method for determining the representativeness of a watershed, and to provide a method for estimating peak rates of runoff from ungaged watersheds. A relationship of watershed characteristics which was derived by coaxial correlation was expressed as,

$$S_c = f(A, \Sigma L, I, L_L, P_{10})$$

where S_c is an estimate of $S_{0.9L}$; $S_{0.9L}$ is a slope defined by dividing the elevation difference between the site and the point 0.9 the length of the water course by the distance between these two points; A is area; ΣL is the total channel length within the basin; I is a soil index reflecting infiltration capacity; L_L is a location parameter, expressed as the difference in degrees between the mean longitude and mean latitude at the centroid; P_{10} is a 24 hr. rainfall in inches having a ten year recurrence interval near the centroid. If the estimated S_c and the measures $S_{0.9L}$ were within 25%, the watershed was accepted as representative. Then S_c was correlated with Q_{10} .

132. Jacquet, J., 1960, Application de la methode de l'hydrogramme unitaire a quelques cours d'eau francais. La Houille Blanche, Vol. 15, No. B: 857-871.

The paper examined hydrological problems likely to be studied by the unitgraph method, in connection with the analysis and reconstitution of flows resulting from a rainfall. Results were presented regarding studies on French streams. The advantages and limitations of the method were discussed.

133. Linsley, R. K. and Crawford, N. H., 1960, Computation of a synthetic streamflow record on a digital computer. Int. Assoc. Sci. Hydrology General Assembly of Helsinki, Publ. 51: 526-538.

Using daily precipitation and potential evapotranspiration as input data, a water-balance accounting procedure was derived for computing mean daily streamflow on a digital computer. Infiltration capacity and percolation to groundwater were varied as functions of soil moisture deficiency. Computed increments of direct runoff were distributed in time by use of distribution percentages, and groundwater flow in the stream was assumed to be a function of total groundwater accumulation. The procedure gave an estimate of total runoff for the ten years of complete record which was six percent too high. Verification of peak flows during flood periods was relatively poor. However, the procedure appeared particularly applicable where a definite rainy season existed or where a basin had a relatively uniform distribution of rainfall throughout the year.

134. Minshall, N. E., 1960, Predicting storm runoff on small experimental watersheds. Proc. A. S. C. E., Vol. 86, HY8: 17-38.

Using the two unitgraph parameters, peak rate and time to peak, the author revealed that both parameters were dependent on rainfall intensity and storm pattern. A method was presented for constructing synthetic unit hydrographs for small drainage areas from 20 acres up to 500 acres involving empirical relationships for the percentage of the peak rate at times before and after the peak in terms of the rainfall intensity and drainage area. Computed hydrographs showed close agreement with the observed record if the unitgraphs were based on storms having similar time and areal distributions. However, storms of different characteristics yielded different unitgraphs.

135. Nash, J. E., 1960, A note on an investigation into two aspects of the relation between rainfall and storm runoff. Int. Assoc. Sci. Hydrology General Assembly of Helsinki, Publ. 51: 567-578.

The moments of the instantaneous unit hydrograph were correlated with the topographical characteristics of the catchment for some English basins.

$$m_1 = 20.7 A^{0.3} S^{-0.3} \quad \text{and} \quad m_2 = 1.0 m_1^{-0.2} S^{-0.1}$$

where m_1 is the first moment about the origin,

m_2 is the ratio of the second moment about the centroid to m_1^2 ,

A is the drainage area, sq. mi.,

S is a measure of overland slope,

A general equation for the unit hydrograph was developed as,

$$u(T, t) = \frac{1}{T} \left[I(n, t/K) - I(n, \frac{t-T}{K}) \right]$$

where $I(n, t/K)$ is the value of the incomplete gamma function of order n at t/K ,

T is duration of effective rainfall.

136. Nash, J. E., 1960, A unit hydrograph study, with particular reference to British catchments. Proc. Inst. Civ. Engrs. Vol. 17: 249-282.

The moments of the instantaneous unit hydrograph were correlated with topographical characteristics for a large number of British catchments, and a general equation for the instantaneous unit hydrograph was chosen. The use of the correlation to predict the hydrograph for catchments where sufficient data is not available was explained with examples.

A condensation of this article was presented by Nash (1960), at the Helsinki General Assembly of the International Society of Scientific Hydrology.

137. O'Donnell, T., 1960, Instantaneous unit hydrograph derivation by harmonic analysis. *Int. Assoc. Sci. Hydrology, General Assembly of Helsinki*, Publ. 51: 546-557.

The effective rainfall hydrograph, the instantaneous unit hydrograph and the surface-runoff hydrograph were each represented by the sum of a harmonic series, each series having the same fundamental time period equal to or greater than the time of storm runoff. Relating the coefficients of the n th harmonics of the three series by simple equations, the harmonic coefficients of the instantaneous unit hydrograph could be derived from the harmonic coefficients of a curve of excess rainfall and the resultant runoff hydrograph.

The approach is somewhat equivalent to the least squares method of Snyder (1955), in that coefficients are determined for each interval.

138. Reich, B. M., (1960) Annotated bibliography and comments on the estimation of flood peaks from small watersheds. *Colorado State University Technical Paper CER60BMR52*.

Publications were reviewed with regard to the estimation of peak runoff from small watersheds, defined as those with areas from 200 acres to 3 square miles. The most useful estimation methods were discussed with emphasis on design methods, and in particular, the procedure of the U. S. D. A. Soil Conservation Service. Areas requiring future research were noted.

139. Remenieras, G., 1960, Determination de l'hydrogramme consecutif a une averse donnee par la methode de l'hydrogramme unitaire. *La Houille Blanche*, Vol. 15, No. 8: 844-846.

The paper described the principle of the unit hydrograph method, and defined its range of application.

140. Riggs, H. C., 1960, Discussion of Application of multiple regression in . . . water yields of river basins, by Sharp, A. L., et al (*JGR* April 1960) *Journal of Geophysical Research* 65:10, 3509-3511 (Oct. 1960)

Multiple regression is a useful tool if the required assumptions can be met. The distinctions between regression and correlation must be recognized because similarity of computations causes belief that they do not differ much.

Linear correlation assumes data are drawn from a bivariate or multivariate normal distribution and observed values are not arbitrarily selected.

Regression does not require that variables be normally distributed, but that dependent variable deviations from regression line be normally distributed with same variance for each value of independent

variable. Independent variables are assumed to be measured without error. When one or more independent variables are not randomly distributed, the correlation coefficient may not give a valid measure of relation between variables.

In application of regression method no two variables should describe the same thing and no variable or part thereof should occur on both sides of the equation. Sharp, et al included two precipitation indices in one equation and used base flow, which is part of total annual flow, as an independent variable. Inclusion of correlated variables does not invalidate the method, but limits sensitivity in assigning significance to individual variables.

141. Rodier, J., 1960, Quelques exemples d'application de la methode de l'hydrogramme unitaire a des bassins versants experimentaux d'Outre-mer. *La Houille Blanche*, Vol. 15, No. B: 847-856.

The unitgraph method was illustrated a number of times, with discussion given to a number of the practical difficulties which arise in its application; such as the heterogeneous nature of precipitation, complex precipitation intensity diagrams, lack of homogeneity of soil and geographical condition.

142. Sharp, A. L., Gibbs, A. E., Owen, W. J., and Harris, B., 1960, Application of the multiple regression approach in evaluating parameters affecting water yields of river basins. *Journal of Geophysical Research* 65:4, 1273-1286 (April)

Hydrologic data, especially that affecting water yield, may not fit the premises upon which multiple regression method is based: (1) No errors in the independent variables, only the dependent variable; (2) Variance of dependent variable does not change with changing levels of independent variables; and (3) Observed values of the dependent variable are uncorrelated random events.

Hydrologic data also may not fit assumption implicit in tests of significance of multiple correlation and regression coefficients that the dependent variable is distributed normally about the regression line for fixed levels of the independent variables.

Conclusions: (1) Although multiple regression gives line of best fit and best estimating equation for hydrologic data, it is not safe to place much reliance on the estimates, especially away from the mean, despite very high correlation coefficients. (2) Other, more modern techniques need to be investigated.

Annual streamflow was dependent variable, X_1 . Independent variables included annual precipitation, X_2 ; ave. December and January (essentially base) flow, X_3 ; a numerical progression, X_4 , to account changes in soil, land use, etc., with time. X_4 was not significant and other variables were tried to include effects of such changes, but none was consistently significant.

143. Tholin, A. L. and Keifer, C. J., 1960, Hydrology of urban runoff. *Trans. A. S. C. E.* Vol. 125, 1308-1355.

The "Chicago Hydrograph Method" was presented, encompassing rainfall-runoff relationships in urban areas based on a design storm of three hours duration, and evaluating in detail the rainfall

abstractions and flow detentions intervening between the hyetograph of rainfall and the hydrographs of sewer supply and outflow. The procedural steps involved the development of a 3 hour design rainfall hyetograph; consideration of an infiltration curve and depression storage in order to obtain overland flow supply curves; the detention of overland flow, and the routing of it over the surface, down gutters, and through both lateral and main sewers; and the attenuation of rainfall with distance from the storm center.

This methodology has been termed an example of the "microscopic approach" to urban storm drainage design.

144. Amorocho, J., 1961, Discussion on "Predicting storm runoff on small experimental watersheds" by N. E. Minshall. Proc. A.S.C.E. Vol. 87, HY2: 187-189.

Nash's parameters, n and c , were correlated with the uniform intensity of excess rainfall.

$$\frac{1}{C} = \alpha = 2\pi \delta^2 \delta_1 I^{2\lambda - \lambda_1} + \frac{0.17}{\delta_1} I^{\lambda_1}$$

$$n = 2\pi \delta^2 \delta_1^2 I^{2(\lambda - \lambda_1)} + 1.17$$

where I is the uniform intensity for excess rainfall,

δ , δ_1 , λ , λ_1 , are obtained from,

$$q_{\max} = \delta I^\lambda$$

$$\text{and } t_p = \delta_1 I^{-\lambda_1}$$

q_{\max} is the peak of the instantaneous unit hydrograph,

t_p is the time to peak.

145. Amorocho, J. and Orlob, G. T., 1961, An evaluation of the inflow-runoff relationship in hydrologic studies. University of California, Sanitary Eng. Res. Lab., Water Res. Center Contrib. No. 41, October.

A model of a hydrologic unit was developed on the basis of a qualitative knowledge of its fundamental functional elements, and its structure was compared with that of a typical regression equation. The conditions for minimum error in the estimates of the outflow of catchments were examined and involved applying the relationships when (a) the observational periods could be chosen such that as many of the variables as possible approached the average values for each set of observations, and (b) the average values became independent of the magnitude of the other variables. In other words, the variance and covariance of terms in the model should approach zero.

146. Amorocho, J. and Orlob, G. T., 1961, Non-linear analysis of hydrologic systems. Water Resources Center Contribution No. 40, University of California, Berkeley, November 1961, 147 pp.

Laboratory model studies indicated marked non-linearity in response of watershed to precipitation. Impulses, square-wave pulses and sequences of square-wave pulses were used in the experimental study.

Functional series solutions are presented as a means of working with nonlinear systems. Although

hydrologic conditions are not time-invariant and cannot generally be considered lumped-parameter systems, there are cases where a watershed approximately meets these requirements for functional series analysis. These techniques are complex and have not been applied to any real problems. Results from lumped-parameter systems are not valid where input is spatially variable.

For systems of simple configuration, arbitrary curve-fitting techniques using functions with the general shape of known responses give good approximations. 40 references.

147. Bender, D. L. and Roberson, J. A., 1961, The use of a dimensionless unit hydrograph to derive unit hydrographs for some Pacific northwest basins. Jour. Geoph. Res., Vol. 66, No. 2: 521-527.

A total of nineteen six hour unitgraphs were used in order to obtain an average dimensionless unit hydrograph. The correct form of this dimensionless unitgraph to be used for synthesis was determined by the time base of a typical flood hydrograph and the duration of excess rainfall as given by the ϕ index method. The time base fixed one dimension, and the duration controlled the volume. Using these criteria, a synthetic unitgraph was selected and a flood hydrograph developed. If the hydrograph synthesized agreed well with the actual one, the synthetic unitgraph was assumed to be true, if there was poor agreement, other time bases were tried until satisfactory correspondence was reached. The trial and error methodology was adapted to a digital computer program.

148. Gray, D. M., 1961, Interrelationships of watershed characteristics. Jour. Geoph. Res. Vol. 66, No. 4: 1215-1223.

An analysis was performed on several topographic characteristics of a number of small watersheds of different vegetative, soil, lithological, physiographic and climatic conditions. The results of the study indicate that the application of dimensional analysis to assist in developing relationships useful for hydrographic synthesis is not feasible unless very careful consideration is given to the selection of independent watershed parameters. It was found that the length of the main stream, L , area A , and length to the center of area, L_{ca} , are highly correlated. The general geometric shape of the small watersheds fell between ovoid and pear shape. The slope of the main stream could be inversely related to the parameters L , L_{ca} , A , as a simple power equation if consideration were given to regional influence.

149. Gray, D. M., 1961, Synthetic unit hydrographs for small watersheds. Proc. A.S.C.E., Vol. 87, HY4: 33-54.

The two-parameter gamma distribution equivalent to the expressions developed by Edson (1951) and Nash (1958), was used satisfactorily to fit dimensionless unit hydrographs.

$$\frac{Qt}{P_R} = \frac{25.0 (\gamma')^q}{\Gamma(q)} (e^{-\gamma' t/P_R}) \left(\frac{t}{P_R} \right)^{q-1}$$

where $\frac{Qt}{P_R}$ is the % of flow / $0.25 P_R$ at any given t/P_R value,

- P_R is the period of rise, from the beginning of surface runoff to the peak discharge,
- γ' is a dimensionless parameter equal to the product γP_R ,
- q is a shape parameter,
- γ is a scale parameter,
- Γ denotes the gamma function,
- e is the base of natural logarithms.

The time of rise, P_R , was found to be a significant parameter. The storage factor, K or P_R/γ' , was significantly correlated with the watershed characteristic $L/\sqrt{S_c}$, where L is the length of the stream and S_c is the channel slope. The relationships for three areas were approximately of the form,

$$\frac{P_R}{\gamma'} = C \left(\frac{L}{\sqrt{S_c}} \right)^{1/2}$$

and had a hydraulic basis. Then the parameter γ' was purely empirically related to the time of rise P_R . As a result, it was found that for uniformly distributed, short-duration, high-intensity storms over small watershed areas, the unit hydrographs could be derived from the watershed characteristic, $L/\sqrt{S_c}$.

150. Keifer, C. J., 1961, Analysis of the urban runoff hydrograph. A. S. C. E. Hydraulic Div. Conference, Univ. of Illinois, August.

This paper was a supplement the Chicago Hydrograph Method of sewer design. The original methodology was simplified to some extent to reduce the number of constants involved in the mathematical formulas. The approach involved a consideration of how the changing of the constants in each of the formulas affected the final hydrographs. Computer trials revealed that the impervious area hydrographs were not greatly affected by variation of any of the variable constants except those for rainfall. On the pervious areas, the constants having the greatest effect were those for rainfall, infiltration, depression storage, and overland flow.

151. Kleen, M. H. and Andrews, R. G., 1961, Central technical unit method of hydrograph development. A. S. A. E. Winter Meeting, Chicago, Dec.

The dimensionless distribution graph approach of the S. C. S. was presented. It involved a system of composite dimensionless hydrographs for each of a number of rainfall distribution graphs. The working relationships between these families of curves and the unit hydrograph are,

$$T_p = \frac{\Delta D}{2} + 0.6 T_c \quad \text{and} \quad q_p = \frac{484 A}{\frac{\Delta D}{2} + 0.6 T_c}$$

where T_p is the time to peak; ΔD is the unit duration, and was set equal to $T_p/4$; T_c is the time of concentration, A is the area. Ten ratios of T_o/T_p were found to be minimal for producing accurate hydrographs,

where T_o is the duration of excess rain. A standard computation was presented.

152. Oakes, C. K., 1961, Hydraulic computations for limited information. Proc. A. S. C. E. Vol. 87, HY1: 85-94.

The writer described methods, together with sample results, which he recommended for use in certain types of hydrologic and hydraulic computations. Included were the rational formula, the unit hydrograph, synthetic hydrographs, log plots of discharge, weir formulas, and low flow considerations.

153. Rainbird, A. F., 1961, Rainfall-river stage relationships for Kempsey. Macleay Valley Flood Forecasting Assignment, Commonwealth of Australia, Bureau of Meteorology, Working Paper 59/2856 Melbourne.

Graphical correlations were developed between catchment rainfall, moisture, status of catchment, season, rainfall duration, and resultant peak flood height of the MacLeay River at Kempsey. The relationship developed gave forecasts with reasonable accuracy of the "class of flood" to be expected. A skewness factor for rainfall was introduced as,

$$\alpha = R_{\max} / \bar{R}$$

but yielded a negative result. A modified factor,

$$\alpha = (R_{\max} - R_{\min}) / \bar{R}$$

also gave a negative result.

154. Watson, B., 1961, Flood routing. Macleay Valley Flood Forecasting Assignment, Commonwealth of Australia, Bureau of Meteorology, Working Paper 60/2891, Melbourne.

A routing procedure which contained an allowance for local inflow was developed for providing forecast information for small floods and for the rising limb of the hydrograph, cases to which the unitgraph procedure is not generally applicable. A crest-stage relationship also provided a useful check on forecasts for the peak stages obtained by the unitgraph approach.

155. Watson, B., and Body, D. N., 1961, Unit-graph derivation and determination of rainfall losses. Macleay Valley Flood Forecasting Assignment, Commonwealth of Australia, Bureau of Meteorology, Working Paper 59/2858, Melbourne.

Unit hydrographs were determined for thirteen floods, and an average one established. It was then observed that peak discharge could be predicted with a standard error of estimate of 18%, and the time to peak within ± 3 hrs., if the excess rainfall could be satisfactorily determined.

A simple linear relationship was established between the antecedent moisture condition of the catchment and the losses which occurred during a storm. Methods available for assessing the antecedent moisture condition were also assessed.

156. Ayers, H. D., 1962, A survey of watershed yield. Univ. of New South Wales Water Research

The survey presented a review of the principles governing the generation of streamflow, and a discussion of experiments and investigations concerning the interrelationships of the significant factors in the hydrologic cycle. Only brief mention was made of the common methods of analysis and interpretation of the results of streamflow measurements. Pertaining to watershed response, one section was devoted to yield from storm rainfall. It was concluded that success in making estimates of storm yield depended upon accurate information of the time variation of rainfall intensity and infiltration capacity on a catchment scale.

157. Body, D. N., 1962, Significance of peak runoff intensity in the application of the unitgraph method to flood estimation. Jour. Inst. Engrs., Australia, 25-31.

The theoretical background of surface runoff was discussed, and it was concluded that it was normal for a watershed to exhibit a trend in the unitgraph peaks derived from storms producing varying peak intensities of runoff. The value of the trend depended upon the storage characteristics of the catchment. Catchments with little storage available would be expected to show a trend for the peak to increase, while those with ample storage would produce lower peaks, with increasing peak runoff intensities. Most catchments were expected to exhibit the former trend, and the neglecting of this effect would lead to underestimation of the extreme flow.

158. Body, D. N., and Watson, B., 1962, The application of hydrological techniques to flood forecasting for the Lower Macleay Valley. Macleay Valley Flood Forecasting Assignment, Commonwealth of Australia, Bureau of Meteorology, Melbourne, April.

Techniques studied and developed in previous parts of the assignment were modified and applied. The effect of areal distribution of rainfall on the shape of the hydrograph was studied and identified for the Macleay River at Kempsey. A rainfall index, B , was defined as the weighted ratio of the rainfalls at two upstream rain-gage stations to rainfalls at two stations lower in the basin. Using these ratios, the storms were divided into two groups: those centered in the headwaters, and those centered near the outlet. A significant difference was observed between the two groups for the unitgraph peaks.

159. Chen, Cheng-lung, 1962, An analysis of overland flow. Ph. D. Dissertation, Michigan State Univ.

A simplified overland flow problem was studied, involving the flow on an impervious sloping plane with a vertical wall at the upstream end and a free overfall at the lower end due to a constant rain. The results tended to confirm the unit hydrograph concept, and even suggested that a universal dimensionless hydrograph might be a practical approximation.

160. Chow, V. T., 1962, Hydrologic design of culverts. Proc. A.S.C.E. Vol. 88, HY2: 39-55.

A method, based on unit hydrograph synthesis, was developed for the estimate of peak discharges from small watersheds in Illinois. Discharge was expressed as the product of a runoff factor, a climate factor, and a peak-reduction factor, each which was empirically evaluated. The runoff factor was determined large-

ly on the basis of a relationship developed by the Soil Conservation Service (1957); the climatic factor reflected the ratio of the total rainfall in a given duration at the location investigated to the rainfall at a base location; and the peak-reduction factor was essentially the ratio between the peak discharge of a unit-hydrograph and the runoff due to the same rainfall intensity continuing indefinitely. The method involved successive computations to maximize the discharge value.

161. Chow, V. T., 1962, Hydrologic determination of waterway areas for the design of drainage structures in small drainage basins. Univ. of Illinois, Eng. Expt. Sta. Bull. 462, Vol. 59, No. 65:

A survey of existing formulas was undertaken, and a new method proposed for estimating peak flows. The basic relationship was of the form, $Q = AXYZ$, where A is area, X is a runoff factor, Y is a climatic factor, and Z is a peak reduction factor. Empirical curves, developed from data in the Illinois area, were presented for design purposes.

162. Crawford, N. H. and Linsley, R. K., 1962, The synthesis of continuous streamflow hydrographs on a digital computer. Stanford Univ. Dept. of Civil Engineering, Technical Report 12. July.

Synthesis of watershed response by model using digital computer. Initial conditions in the watershed are estimated and (mean hourly) rainfall enters model. Rainfall is divided between runoff from impervious surfaces and upper zone storage (UZS). UZS loses some moisture to evaporation and part goes to direct runoff (interflow and surface runoff). The rest of UZS moves to lower zone storage (LZS) by infiltration. LZS is divided between evapotranspiration and groundwater storage. Ground water storage contributes to base flow and subsurface outflow from basin.

Surface runoff from impervious surfaces and direct runoff is routed through channel flow and is combined with interflow, which is routed through different storage, and baseflow to make the hydrograph.

Movements between storages and losses to evapotranspiration depend on the quantities of water in the various storage regimes. [Later version. 1966]

163. Eagleson, P. S., 1962, Unit hydrograph characteristics for sewered areas. Proc. A.S.C.E. Vol. 88, HY2: 1-25.

The lag time, peak discharge, and width of the unit hydrograph at some percentage of the maximum discharge were related to basin and sewer characteristics. Rainfall excess was determined from

$R. E. = (1 - A)P$, where A is the slope of a precipitation-loss curve, i. e., losses vs P . Lag-time was theoretically computed by means of a weighted Mannings relationship and the mean travel distance. Peak discharge was correlated with mean basin slope; and the unit hydrograph base width, W_0 , and the widths at 50% and 75% of Q_{max} were expressed analytically as functions of Q_{max} . A suggested design procedure was also outlined.

164. Getty, H. C., and McHughes, J. H., 1962, Synthetic peak discharges for design criteria. Proc. A.S.C.E. Vol. 88, HY5: 1-12.

An analog computer was devised to calculate runoff increments from average rainfall rates. It was based on the S. C. S. equation,

$$Q = \frac{P^2}{P+S}$$

where Q is direct runoff; P is storm rainfall; S is the maximum potential difference between P and Q at the time of the storm's beginning.

170. Viessman, W., and Geyer, J. C., 1962, Characteristics of the inlet hydrograph, Proc. A.S.C.E., Vol. 88, HY5: 245-268.

A study of the relationship between rainfall and runoff for impervious areas ranging in size from 0.40 to 1.93 acres yielded equations for the determination of peak rates of runoff and time of rise of the inlet hydrograph, and a method for predicting the shape of a simple hydrograph. The peak rate relationship was:

$$Q = \frac{0.769}{n_s} D^{0.09} T^{0.16} i^{0.88} A^{0.95} S^{0.17}$$

where Q is peak discharge in cfs, n_s is Manning's roughness coefficient, D is the total depth of rainfall during time T , i is the mean intensity for the peak minute plus the minute preceding it, A is the area, S is the main channel slope. When used for areas less than 5 acres, on impervious ground with mean gutter slope less than 0.5%, the equation may be expected to yield errors less than $\pm 20\%$, 75% of the time. The time of rise of each inlet hydrograph was determined to be a function of T_s , the time from the beginning of the storm rainfall to the end of the maximum minute of rainfall minus the time during which the first 0.10" of rain fell for one area (0.05 and 0.07" for other areas), as

$$T_r = 77.8 + 1.011 T_s$$

The rising segment of the hydrograph was determined to be:

$$Q_t = Q e^{-c_1^2 t_1^2}$$

where Q_t denotes discharge at time t ; Q refers to peak discharge;

$$c_1 = 1/\sqrt{2\sigma_R^2}$$

in which σ_R represents the standard deviation of the normal distribution producing a rising curve equivalent to the rising limb of the hydrograph-- $\sigma_R = 0.40 T_r$; t_1 is the time between Q and Q_t . The upper portion of the recession curve was represented by:

$$Q_t = Q e^{-c_2^2 t_1^2}$$

where $C_2 = 1/\sqrt{2\sigma_F^2}$, and σ_F is determined empirically. The lower portion of the recession was found to follow:

$$Q_{t2} = Q_{\infty} e^{-kt_2}$$

171. Watson, B., Catchment water yield and flood flows, 1962, Commonwealth of Australia, Bureau of Meteorology Working Paper 62/1480, July.

A general discussion of watershed yield was presented. It was concluded that one of the more urgent fields of endeavor was the preparation of rainfall-runoff relationships for the estimation of streamflow from ungaged catchment areas.

172. Woo, Dah-Cheng, 1962, Spatially varied flow from controlled rainfall, Proc. A.S.C.E. Vol. 88, HY6: 31-56.

A study was performed on spatially varied flow produced by uniform rainfall on two types of impervious surfaces for slopes from 0 to 0.06. An equation for the water surface profile was developed on the assumptions that the rainfall was uniform and constant, the surface was impervious and of uniform width, the surface slope was uniform and small, the effect of nonuniform flow and impact of rain drops could be included by changing the friction factor, the coefficient of momentum was unity, and the flow was in equilibrium. A rainfall applicator was developed and simulated rainfall was applied to a 30 ft. flume, 6" wide. Values of the effective friction factor were evaluated for various reaches and plotted with respect to Reynolds number and slope. Neglecting the experimental results on the upper portion of the flume, the effect of raindrop impact was clearly expressed in terms of uniform flow condition, slope, and Reynolds number.

173. Amorocho, J., 1963, Measures of the linearity of hydrologic systems, Jou. Geo. Res., Vol. 68, No. 8:2237-2249.

The non-linear response of watersheds under rainfall was represented by means of functional series incorporating mathematical operations equivalent to the physical action of these systems. The usual shape of the responses of hydrologic systems seemed to support the likelihood that, at least for the rising limbs of most single-peaked hydrographs, very close approximations could be obtained by suitable Taylor series expansions. A measure of the degree of linearity of the system was based on the evaluation of the relative importance of the linear and non-linear terms in the functional series. Laboratory test runs were made, and revealed that the response became increasingly non-linear as the input continued, but approached linearity after the cessation of input. Hence, the recession was more readily predictable by a linear operation.

174. Crawford, N. H. and Linsley, R. K., 1963, A conceptual model of the hydrologic cycle, International Assn. of Scientific Hydrology Publication No. 63, pp. 573-587.

Stanford Watershed Model Mark II utilizes hourly rainfall and daily evapotranspiration data to generate outflow hydrograph. [See 1966 for later version of model]

Precipitation is divided into infiltration and runoff [with some loss to evaporation]. Infiltration moves to ground water with evapotranspiration loss and ground water loses some evapotranspiration. Runoff is routed through interflow or channel flow to give streamflow hydrograph.

175. Dickinson, W. T., 1963, Unit hydrograph characteristics of selected Ontario watersheds, M. S. A. Thesis, Univ. of Toronto.

Thirty-two pairs of unitgraphs were developed for five selected watersheds, from 48 to 518 sq. miles. Each pair consisted of graphs derived from two methods of baseflow separation. A purely

straight line method of separation yielded runoff volumes 10 to 20% larger, and unitgraph peaks 5 to 15% smaller, than a method involving the normal recession curve and a straight line. The time to peak was not affected. The areal distribution of rainfall was evaluated for each storm by an areal distribution index. For each watershed considered, no real effect of areal distribution was recognizable. The variability within watersheds of unitgraph peaks was reflected by a coefficient of variation between .07 and .17; and of times to peak by values of .05 to .15.

176. Henderson, F. M., 1963, Some properties of the unit hydrograph, Jour. Geophysical Research, Vol. 68, No. 16: 4785-4793.

The instantaneous unit hydrograph and the properties connecting it with the unit hydrograph for a rainfall excess of any finite duration were used to explore the relationship between the peak flow of a unit hydrograph and the duration of rainfall excess causing it. This relationship was found to be substantially independent of the skew or any other shape factor of the iuh, and dependent only on its base width. However, it was found to be strongly dependent on the distribution of rainfall excess intensity over the duration of the storm.

177. Holton, H. N., and Overton, D. E., 1963, Analyses and application of simple hydrographs, Jour. of Hydrology, Vol. 1: 250-264.

A method was developed for determining the peak discharge and time to peak of a flood hydrograph. It was assumed that the time of rise was equal to the storm duration and that the entire recession limb occurred after the storm ceased and represented only flow out of storage. On this basis, an equation was developed which was equivalent to that of Zoch. Assuming the volume yielded by the rising limb to be equivalent to that in a simple triangle of height equal to peak discharge and base equal to rain duration, a simple equation for peak flow was developed. Assuming the storage coefficient was equal to the time lag between the centroid of rainfall excess and the mid-volume of runoff, the hydrograph was also positioned in time.

Although the assumptions appear restrictive and questionable, the comparative results for simple hydrographs were good.

178. Kishi, Tsutoma, 1963, Application of computers on runoff analysis, Proc. VIIIth Congress of Hydraulic Research, Society of Civil Engineers, Japan. (Japanese)

Method of characteristics applied to runoff analysis:

$$h = K'q^{0.6} \quad K' = (n'/\sqrt{\sin\theta'})^{0.6}$$

n' = roughness coef.
 $\sin\theta'$ = inclination of basin surface.

$$\frac{\partial h}{\partial x} + \frac{\partial q}{\partial x} = r_e(t)$$

[Assumes rectangular surface]

Characteristic equation:

$$\frac{dx}{1} = \frac{dt}{0.6K'q^{-0.4}} = \frac{dq}{r_e(t)} \quad (3)$$

$$dt = \frac{0.6K' dx}{q^{0.4}} = \frac{K dx}{q^{0.4}} \quad (4)$$

$$\int_{\tau}^t r_e(t) dt = \frac{K}{0.6} (q_t^{0.6} - q_{\tau}^{0.6}) \quad (5)$$

For grid of points on time and space:

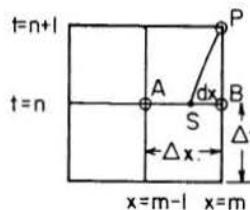

Let a characteristic curve go through as shown for SP. Let q be known at $t = n$ and let rainfall be given as $R(t)$. Then from eq. (5)

$$q_{m,n+1}^{0.6} - q_{s,m}^{0.6} = \frac{0.6}{K} R(t) \Delta t$$

$$q_{m,n+1} = \left[\frac{0.6}{K} R(t) \Delta t + q_{s,m}^{0.6} \right]^{1/0.6}$$

from eq. (4)

$$\overline{SB} = dx = \frac{\Delta t q_{m,n}^{0.4}}{K} \quad \text{if } q_s \approx q_B$$

$$q_{s,n} = q_{m,n} \left[1 - \left(\frac{\Delta t}{\Delta x} q_{m,n}^{0.4} / K \right) \right] + q_{m-1,n} \left(\frac{\Delta t}{\Delta x} q_{m,n}^{0.4} / K \right)$$

$$= q_{m,n} (1 - S \cdot P_{m,n}) + q_{m-1,n} S \cdot P_{m,n}$$

$$S = \frac{\Delta t}{\Delta x} \quad \text{and} \quad P = q^{0.4} / K$$

Condition for stability is $S \cdot P_{\max} < (\Delta x < \Delta x)$

179. Kolher, M. A., 1963, Simulation of daily catchment water balance, National Symposium on Water Resources: Use and Management. Australian Academy of Science. Melbourne Univ. Press. Victoria.

A model was developed which yielded predicted six hour increments of runoff and moisture deficiencies. Moisture depletion was assumed to be due entirely to evapotranspiration. Initially, the evaporation was based on two levels of moisture storage; and later the model incorporated multi-capacity accounting. It was assumed that evaporation occurred from that portion of the area having a prescribed storage capacity at the potential rate so long as there was any moisture remaining. The potential rate was equivalent to evaporation from an extended free-

water surface. The volume of rainfall excess was determined as that volume resulting from rainfall intensities in excess of the infiltration rate. Using Horton's infiltration theory, Kohler suggested an exponential infiltration curve and selected the starting point on the curve by considering the soil moisture deficiency.

180. Laurenson, E. M., 1963, Hydrograph synthesis for ungaged watersheds, 4th Biennial Hydraulics Conf. Washington State Univ., October.

A nonlinear conceptual model for watershed response was presented and illustrated. A particular catchment was divided into 10 sub-areas. The rainfall excess of the uppermost sub-area was routed through a single nonlinear concentrated storage of the form:

$$S = K_m(q) \cdot q$$

where S was the storage volume; q was the outflow; and $K_m(q) = C_1 q^{C_2}$; C_1 and C_2 were constants for the watershed sub-areas. The output from this storage was combined with the rainfall excess from the second sub-area, and the combined flow routed through a second nonlinear storage, and so on. The parameters to be evaluated were simply the K_m 's for the various storages, if the sub-areas were delineated by isochrones in such a way that the travel time increments were equal. The results checked well for major floods, but not so well for minor ones. The method of determining the rainfall excess was unclear.

181. Roche, M., 1963, Hydrologie de surface. Gauthier Villars Editeur. Paris.

The topic of watershed response was considered primarily under the title of analytical hydrology. In particular, the concept of interflow was questioned. The author suggested that most of this flow was constituted by flow through vegetation, and not laterally moving flow through the soil above the water table. The basis, methodology, and practicality of the unit hydrograph approach were discussed, and the synthetic hydrograph was presented. Mathematically, it was expressed,

$$Q(t) = \int_{\theta=0}^t \int_{\tau=0}^t c(\tau) I(\tau, \theta) r_{\theta}(t-\tau-\theta) S'_{\theta} d\tau d\theta$$

where $Q(t)$ is total runoff; θ represents an isochrone of equal time from the outlet; t is the time of runoff, τ is the time of rainfall, $c(\tau)$ is a simplified runoff coefficient; $I(\tau, \theta)$ represents the time and space distribution of rainfall; $r_{\theta}(t-\tau-\theta)$ is equivalent to the instantaneous unit hydrograph for a particular areal segment; $S'_{\theta} d\theta = dS_{\theta}$ is an incremental surface area.

182. U. S. Army Corps of Engineers, 1963, Unit hydrographs, Part 1. Principles and determinations, Civil Works Investigations, Project 152, Maryland.

The report contains material, discussions, and examples of methods and procedures. Unit hydrograph theory was reviewed, and some of the current techniques and applications were presented.

183. Watkins, L. H., 1963, Research on surface-

water drainage, Proc. Inst. Civ. Engrs., Vol. 24: 305-330.

A method was devised by the Road Research Laboratory, known as the R. R. L. hydrograph method, for calculating rates of storm runoff in sewer systems. The hydrograph was calculated by assuming that at the end of the first unit time, the rate of runoff was given by the product of the first rate of rainfall and the first increment of area; at the end of the second unit time the first rate of rainfall would be running off from the second increment of area, together with the second rate from the first increment of area. The effective rainfall rates used were obtained by modifying the recorded rates by a constant runoff percentage. A retention curve, based on the recession curve, was used to modify the calculated runoff hydrographs.

The method essentially involves the determination of an inflow hydrograph developed from the time-area diagram and a modified rainfall intensity curve and the routing of this hydrograph through a storage reservoir having characteristics reflected in the recession limb.

184. Watkins, L. H., 1963, The design of storm sewer systems, Jour. Inst. Munic. Engrs., Vol. 90. No. 11: 337-341.

The Road Research Laboratory Hydrograph method of designing urban sewer systems was introduced. The method determined the full hydrograph of runoff, taking into account (a) the variation of rate of rainfall during the storm, (b) the shape of the time-area diagram, and (c) the variation in the volume of water temporarily retained in the sewer system. Only a few trials of the method were presented in the paper.

185. Wu, I-Pai, 1963, Design hydrographs for small watersheds in Indiana., Proc. A. S. C. E., Vol. 89, HY6: 35-66.

Unit hydrograph and watershed characteristics were related. The shape of the hydrograph was determined by the time to peak and the storage coefficient. The numerical parameter of Nash's formula could be evaluated from the recession curve, and vice versa. The watershed characteristics were area, length of main stream, and mean slope of the main stream. A constant runoff coefficient was used to determine the volume of rainfall excess. The basic data was from 21 watersheds, less than 100 sq. miles, located in Indiana.

186. Amorocho, J. and Hart, W. E. 1964, A critique of current methods in hydrologic systems investigation, Trans. American Geophysical Union 45: No. 2, 307-321, June.

Current work in hydrologic studies indicates a dichotomy between the pursuit of scientific research into the basic operation of components of the hydrologic cycle and the desire to establish workable relationships between measurable parameters for use in solving practical problems. Methods in the latter group are discussed in this paper.

Methods of system investigation of hydrologic relationships are divided into two classes--parametric hydrology, the development of relationships among physical parameters to generate or synthesize non-recorded hydrologic sequences; and stochastic hydrology, the use of statistical characteristics of

hydrologic variables to solve hydrologic problems.

Conclusions on methods discussed:

Correlation and regression analysis--valuable for testing well-grounded hypotheses, but as direct tools in synthesis may lead to dangerous results and unwarranted generalizations.

Linear systems analysis and partial synthesis (unit hydrograph)--can lead to gross errors in results, but may be of value in practice where system non-linearities are highly damped. (E.g. unit hydrographs applied to upper tributaries, with results routed through stream network)

General system synthesis (Stanford model)--reasonably successful and valuable for short-range forecasts, but lack of knowledge in modeling components could lead to unpredictably erroneous results in long-term inferences.

Non linear analysis--new area lacks rigorous methods and gives no indications of component effects, but may eventually be valuable in studying changes in regime of a watershed.

Stochastic hydrology methods (Monte Carlo and Markov techniques)--dependent on statistical properties of available data. Unless actual chronologies are used, caution must be used in interpreting results.

187. Betson, R. P., 1964, What is watershed runoff?, Jour. Geo. Res., Vol. 69, No. 8:1541-52.

A nonlinear mathematical model starting with the integral of a standard infiltration function was developed to analytically equate the difference between rainfall and runoff to storm rainfall duration and soil moisture. The function may be useful in estimating the volume of storm runoff.

188. Chow, V. T., 1964, Handbook of applied hydrology, McGraw-Hill Book Co., New York.

This comprehensive handbook yields useful information on virtually all areas of hydrology. A section on the time and space distribution of runoff is particularly informative.

189. Henderson, F. M and R. A. Wooding, 1964, Overland flow and groundwater flow from a steady rainfall of finite duration, Jour. of Geophysical Research, Vol. 69, No.8: 1531-1540.

The building and decay of a laminar or turbulent flow over a sloping plane was treated by the kinematic wave method, neglecting the slope of the water surface relative to the slope of the plane. The relationships developed showed certain differences from those postulated in the unit hydrograph method. The time to equilibrium was found to be dependent on the intensity and depth of rainfall excess. Further the maximum discharge occurred as an instantaneous peak only when the duration of rainfall was equal to the time of equilibrium. A comparison of the results with the data of Hicks (1944) was quite favorable. The problem was also extended to include groundwater flow through a porous medium overlying a sloping impermeable stratum where water was supplied by infiltration from the ground surface.

190. Kleen, M. H., 1964, Hydrology for soil and water conservation in the coastal regions of north Africa, S. C. S. Handbook.

This handbook was prepared for the use of the U. S. Soil Conservation Service personnel on assignments in the coastal regions of North Africa. It gave the S. C. S. procedures for estimating precipitation and runoff relationships on small drainage areas.

191. Kulandaiswamy, V. C., 1964, A basic study of the rainfall excess-surface runoff relationship in a basin system, Ph. D. Dissertation, University of Illinois.

Given the time distribution of rainfall excess and the corresponding surface runoff for a basin system, the investigation established a mathematical expression for the process which converted the rainfall excess into surface runoff. It was observed that the process was nonlinear, but that the nonlinear effects did not seem to be large. The storage in the basin could be satisfactorily expressed by:

$$S = a_0 Q + a_1 \frac{dQ}{dt} + a_2 \frac{d^2 Q}{dt^2} + b_1 \frac{di}{dt} + b_0 i$$

where the b coefficients vary randomly from storm to storm; the a coefficients decrease with increase in Q_p , meaning that for major storms the peak is higher and the time to peak of the I. U. H. lower than for minor ones. A satisfactory correlation was also established for rainfall excess and the peak of surface runoff.

192. Laurenson, E. M., 1964, A catchment storage model for runoff routing, Journal of Hydrology 2: 141-163.

Requirements of input and storage models: (i) Temporal variations in rainfall-excess; (ii) areal variations in rainfall excess; (iii) different elements pass through different amounts of storage; (iv) catchment storage distributed, not concentrated; and (v) discharge vs. storage is non-linear. Multiple routing through series of concentrated storages is used. Non-linear, coefficient type routing similar to Muskingum method used. Total area divided into sub-areas with lumped (concentrated) parameters.

Overall routing procedure: (i) Hyetograph for farthest upstream subarea determined with shape given by nearest recording gage and scaled to make max. ordinate = ave. rainfall for subarea. (ii) Losses subtracted to give rainfall-excess. (iii) Hyetograph converted to "inflow hydrograph", $Q = iA$. (iv) Hydrograph routed through storage for subarea. (v) Next subarea "rainfall hydrograph" developed and added (with time phase shift) to outflow hydrograph from upstream. Combined hydrograph routed through appropriate storage.

Non-linear routing method:

$$S = K(q) \cdot q$$

$$(i_1 + i_2) \frac{\Delta t}{2} - (q_1 + q_2) \frac{\Delta t}{2} = S_2 - S_1$$

$$q_2 = C_0 i_2 + C_1 i_1 + C_2 q_1 \quad (11)$$

$$\left. \begin{aligned} C_0 &= C_1 = \frac{\Delta t}{(2K_2 + \Delta t)} \\ C_2 &= \frac{(2K_1 - \Delta t)}{(2K_2 + \Delta t)} \end{aligned} \right\} \quad (12)$$

1 = start of period 2 = end of period

Since K_2 depends on q_2 , Eq. (11) is solved iteratively. Let $K_2 = K_1$ and find q_2 , redetermine K_2 and iterate.

193. Lienhard, J. H., 1964, A statistical mechanical prediction of the dimensionless unit hydrograph, Jour. Geo. Res., Vol. 69: 5231-5238.

A purely statistical approach was used to develop hydrographs. The inquiry stemmed from the noted similarity between the Maxwell-Boltzman molecular speed distribution and the dimensionless hydrograph, expressed as:

$$\frac{Q}{Q_c} = f_2(t/t_c)$$

where Q is discharge rate; Q_c is a characteristic of storm intensity, usually peak discharge; t_c is the time lag. Assuming that the storm is brief compared to t_c , that t_i is proportional to l_i , and that it subtends an area proportional to l_i^2 (l_i is travel distance to gaging station), a distribution function was developed. The approach, and its verification on two small basins, revealed that the form of the dimensionless unit hydrograph is very nearly independent of watershed properties and that it is predictable with a minimum use of such properties.

194. Ramaseshan, S., 1964, A stochastic analysis of rainfall and runoff characteristics by sequential generation and simulation, Ph. D. Dissertation, Univ. of Illinois.

The hydrologic phenomena of storm precipitation and the associated runoff were considered as a complex stochastic process. A conceptual model was formulated involving storm precipitation, the abstractions, the routing system, the baseflow, direct surface runoff, and the stream flow. Hourly precipitation was considered as a finite duration process. A "shift analysis" was developed for arranging the historical data in a manner so that the results were stable, consistent, and regular. The models were of the general form:

$$x_t = f_{t,1}(x_{t-1}) + f_{t,2}(x_{t-2}) + \dots + f_{t,t-1}(x_1) + \epsilon_t$$

where x_t is the precipitation at time t , ϵ_t is its random component, and the f 's are various functions. The following Markov model was best -

$$x_t = A_t x_{t-1} + \epsilon_t$$

where A_t is a constant coefficient. ϵ_t is shifted by K_t and $\epsilon_t' = \epsilon_t + K_t$ is lognormally distributed. Nash's model was adopted. One thousand storms were generated, and the resulting floods studied.

195. Singh, K. P., 1964, Non-linear instantaneous unit-hydrograph theory. Proc. A. S. C. E. Vol. 90, HY2: 313-347.

A proposed non-linear theory accounted for the variability of instantaneous unit hydrographs derived from different storms over a number of

drainage basins, 0.4 to 875 sq. miles, in terms of 3 parameters and a functional parameter $W(\tau)$. The basic equation was

$$u_t = \frac{1}{K_2 - K_1} \int_0^{t_1} \left(e^{-\frac{t-\tau}{K_2}} - e^{-\frac{t-\tau}{K_1}} \right) W(\tau) d\tau$$

where u_t is the iuh ordinate at time, t , after occurrence of instantaneous unit rainfall excess; K_1 is the channel storage discharge factor; K_2 is the overland flow storage discharge factor; $W(\tau)$ is the ordinate of the conc. -time diagram with base equal to T ; the time of conc. τ is the variable travel time. The nonuniform areal distribution of rainfall excess was accounted for in the conc. -time diagram; the effects of duration and nonuniform time distribution of average rainfall excess were condensed into R_e , the equivalent instantaneous rainfall excess.

In applying the model, the author reduced the number of variables to two, by assuming $K_1 = 0.25$. Further, the area-time diagram was considered to be one of six standard curves.

196. Wu, I. P., Delleur, J. W., and Diskin, M. H., 1964, Determination of peak discharge and design hydrographs for small watersheds in Indiana. Purdue University, Hydromechanics Lab., October.

Two simple equations were presented for the determination of peak discharge of flow from small rural watersheds in Indiana. Wu's method (see Wu (1963)) for obtaining a design hydrograph of runoff from small rural basins, 3 to 100 sq. mil, was also given.

197. Crawford, N. H., 1965, Some observations on rainfall and runoff. Western Res. Conf., C. S. U., Fort Collins, July.

A very brief general discussion was presented regarding the relationships between rainfall and runoff. Some illustrations from models synthesized by the Stanford Watershed Model IV were used.

198. Dawdy, D. R. and O'Donnel, T., 1965, Mathematical models of catchment behavior, Proc. A. S. C. E. 91: HY4, 123-137, July.

After brief discussion of mathematical models --unit hydrograph, non-linear analysis (Amorocho) and Stanford synthesis model--the authors turn to the optimization of model parameters.

Sum of squares of deviations of model output from known output was minimized as criterion for optimizing parameters. Known output was obtained by giving values to parameters and generating an "error-free" model response. Optimization technique is judged by its ability to generate the given parameter values from an initial set of "wrong" values.

Optimization technique was a steepest-descent method (Rosenbrock's) which is designed for parameters with specific ranges and an objective function whose partial derivatives cannot be stated analytically.

Watershed model was simplified form of Stanford model. Sensitivity of the objective function to parameter values was examined and appeared to affect rate of convergence of model parameter to known value.

Current optimization procedures and computers limit the number of parameters that may be optimized. Objective techniques for optimizing model parameters should be studied more.

199. Dickinson, W. T., and Ayers, H. D., 1965, The effect of storm characteristics on the unit hydrograph. Trans. E. I. C., Vol. 8, No. A-15: 3-7.

The effects of areal and time distribution of rainfall and of storm magnitude on 32 unit hydrographs developed for five selected Ontario watersheds of 48 to 518 sq. miles were studied. The study failed to establish any significant effects. An areal distribution index for rainfall was developed, based on the use of effective stations and isohyetal maps, and found to readily describe the distribution. A temporal distribution index, based on a unitless mass rainfall curve, was also developed, but proved to require further investigation. Average unitgraphs were presented for the five basins.

200. Diskin, M. H., 1965, Hydrologic models of direct surface runoff, Hydraulic Symposium May 26, 1965, Technion-Israel Institute of Technology, Haifa pp. 21-30.

Separation of rainfall excess from the hydrograph and direct surface runoff from the hydrograph give excess and runoff as functions of time. The two are related by an operator ϕ : $Q(t) = \phi [R(t)]$. The time scale, the input scale and output scale may be adjusted in model tests. Main problem is defining the transformation process or operator ϕ .

Model studies using tanks and topographic models have been used as have analog models and digital simulation models. Author is currently (1965) using a model with a salt solution in water flowing through a layer of coarse gravel. The watershed is represented by the steady state flow and the concentration of salt represents the rainfall and runoff. This model can be rapidly changed to different conditions.

201. Eagleson, P. S., Mejia, R. and March, F., 1965, The computation of optimum realizable unit hydrographs from rainfall and runoff data, Massachusetts Institute of Technology Hydrodynamics Lab. Report No. 84, September.

Three approaches to finding IUH: (1) General system synthesis derives response from knowledge of individual processes. (With valid descriptions of processes IUH not needed). (2) Parametric system synthesis assumes a linear model of basin made up of monotone linear elements. Parameters are then determined from input-output data. (3) Black box analysis assumes processes in basin are linear, but form is not given. IUH is found from input-output data alone. This report deals with black box approach only.

Any linear system is uniquely characterized by its unit impulse response (or by any integrals of it). Input-output relationship is convolution integral or for discrete form

$$g(i) = \sum_{j=1}^i f(j) h(i-j+1) \Delta j$$

$g(i)$ = output, $f(j)$ = input, $h(i)$ = unit impulse response.

The least squares fit to the IUH generates a system of Wiener-Hopf equations which, in linear form, are

$$\phi_{id}(k-1) = \sum_{j=1}^n h_{opt}(j) \phi_{ii}(k-j), \quad j > 0$$

where

$$\phi_{id}(k-1) = \sum_{i=1}^n f(i) g(i+k-1)$$

and

$$\phi_{ii}(k-j) = \sum_{i=1}^n f[i+(k-j)] f(i)$$

By writing the Wiener-Hopf equations as inequalities and using the minimization of the sum of the slack variables as the objective function, a linear programming problem is generated. Linear programming uses only non-negative (i.e., physically realizable) values of variables. Thus, output from linear program is optimum realizable unit hydrograph for given input and output data with the assumption that the system is a black box with linear components. (See also 1966)

202. Koyo, Tatsugami, 1965, New method on runoff analysis, Chubu District Division. Construction Ministry, Japan. (Japanese)

Modified unit graph method:

Divide basin into sub areas with $\frac{\Delta A}{\Delta L} = \text{constant}$.

Center of area i at distance L_i along main stream.

Assume (according to Dr. Nakayasu)

$$T^1 = \alpha^1 L_i^{0.7} \quad T^1 = \text{lag time}$$

$$\frac{\Delta A}{\Delta T^1} = \frac{1}{\alpha^1} \frac{L_i^{0.3}}{0.7} \frac{\Delta A}{\Delta L}$$

If uniform rainfall ($\frac{1}{a}$ mm/hr) continues for unit time (a hours)

$$i = \frac{1}{3.6} \frac{\Delta A}{\Delta T^1} = \frac{1}{3.6} \frac{1}{\alpha^1} \frac{L_i^{0.3}}{0.7} \frac{\Delta A}{\Delta L}$$

Need to determine α^1 . Let $\alpha^1 = 1$. This is "tentative runoff concentration function". Assuming storage given by $S = kq$ and continuity $\frac{\Delta S}{\Delta t} = i - q$, determine lag time of computed hydrograph. If it differs from observed lag, adjust α^1 to get agreement. $[K = \frac{1}{C_d}]$ where

C_d is recession constant from semi log plot of hydrograph recession]

Unit graph base duration obtained as time from beginning of last effective rainfall intensity to

end of direct runoff. [End of direct runoff obtained from break in slope of recession on semi log plot.]

The computed unit graph is used to generate hydrograph for given storm. The ratio of observed runoff to computed runoff is called a runoff coefficient and for peak flows $f_p = 0.193Q_p^{0.080}$ for the Kiso River.

203. March, F. and Eagleson, P. S., 1965, Approaches to the linear synthesis of urban runoff systems, Massachusetts Institute of Technology Hydrodynamics Lab. Report No. 85. 48pp. + 3App.

General drainage basin model using a system of linear elements is presented. Unit hydrograph models of Zoch, Singh and Nash are shown to be special cases of the general model.

Black box analysis, assuming linear system, gave better agreement with the observed hydrographs from the runoff of the Johns Hopkins Storm Drainage Project gaging area than any of the parametric models. (Parametric models develop form by conceptual model and evaluate parameters from observed data).

No single instantaneous unit hydrograph (including black box approach) was suitable for all flows from a drainage area.

One-parameter Zoch model gave better results than two-parameter Nash or Singh.

Method of moments did not provide good fit to unit hydrograph forms.

204. Morgali, J. R., and R. K. Linsley, 1965, Computer analysis of overland flow, Proc. A. S. C. E. Vol. 91, HY3: 81-100.

The hydrographs of overland flow were synthesized for uniform rainfall on an impermeable flow plane of constant slope, with uniform surface texture and a given length. The equation derived by finite differences, boundary and initial conditions made up a mathematical model of the physical flow situation which was solved by digital computer. The parameters influencing hydrograph shape were slope, roughness, plane length, and rainfall intensity. Families of hydrographs were presented for various parameters, and a single dimensionless hydrograph was developed. Using a relation for the time to equilibrium and the dimensionless hydrograph, the hydrograph for any combination of parameters could be constructed.

205. Restrepo, J. C. O. and Eagleson, P. S., 1965, Optimum discrete linear hydrologic systems with multiple inputs. Massachusetts Institute of Technology Hydrodynamics Lab. Report No. 80, August.

Using the convolution operation between vectors \underline{f} and \underline{h} for stationary linear systems, the output of a system is given by

$$\underline{g} = \underline{f} * \underline{h}; \quad g(n) = \sum_{k=0}^{\infty} f(k) h(n-k)$$

where \underline{g} is the output vector, \underline{f} is the input vector and \underline{h} is the unit impulse response (response of system to unit impulse).

The vectors are transformed by a geometric transform (z - transform)

$$f^g(z) = \sum_{n=0}^{\infty} f(n) z^n$$

(z = a complex variable) because convolution becomes multiplication in the transform domain.

For multiple inputs and outputs a matrix notation is useful. Thus, $\underline{g} = \underline{f} * \underline{H}$ where $\underline{g} = [g_1, g_2, \dots, g_M]$, $\underline{f} = [f_1, f_2, \dots, f_N]$

and $\underline{H} = [h_{ij}]$ with g_i , f_j and h_{ij} being vectors.

The problem in hydrology is estimating \underline{H} from sample data on \underline{f} and \underline{g} .

For the hydrologic system with one input and one output, the unit impulse response, $h(n)$, is a form of the instantaneous unit hydrograph. The linear reservoir systems of Zoch, Nash and Dooge are examined within the framework of the linear system analysis and are shown to imply specific internal structures for the system.

$$\text{Letting } g^*(i) = \sum_{k=0}^{\infty} h(k) f(i-k) \quad i = 0, 1, \dots$$

be the prediction equation for the system outputs and using the least squares criterion of minimizing

$$\sum [g(i) - g^*(i)]^2, \text{ the Wiener-Hopf equations}$$

are generated. $\phi_{fg} = \underline{h} * \phi_{ff}$ where

$$\phi_{ff}(i) = \sum_{k=0}^{\infty} f(k) f(k+i) \quad \text{and} \quad \phi_{fg}(i) = \sum_{k=0}^{\infty} f(k) g(k+i).$$

This is a system of equation that can be solved to give the least squares estimate of \underline{h} .

The case of two inputs and one output is used as an example because hydrologic systems have initial moisture conditions that affect response and this could be approximated by a second input (besides rainfall).

206. Rodriguez-Iturbe, I., 1965, Annotated bibliography on synthetic unit hydrographs. Calif. Inst. of Tech., Tech. Memo 65-4, May.

A fine annotated bibliography was presented of twenty-two recent publications.

207. Wooding, R. A., 1965, A hydraulic model for the catchment-stream problem, Journal of Hydrology 3: 254; 3: 268 (1965); 4:21 (1966)

Channel flow with distributed inflow:

$$\frac{\partial H}{\partial t} + \frac{\partial Q}{\partial x} = q_i \quad (q_i = \text{inflow to segment } i)$$

and $Q = AH^N$, where Q is discharge rate, H is stage. ($N = 1.5$)

For overland flow--thin sheet at low Froude number:

$$\frac{\partial h}{\partial t} + \frac{\partial q}{\partial x} = v-f \quad \text{and} \quad q = \alpha h^n,$$

where q = discharge per unit width, h is water depth, v is input (precipitation) and f is loss to infiltration, evaporation, etc. ($n = 2$)

Kinematic wave approximation applied for each part of flow.

Catchment flow: Let

$$h = 0 \begin{cases} 0 \leq x < L, t = 0 \\ t > 0, x = 0 \end{cases}$$

and

$$c(h) = \frac{dq}{dh} = n\alpha h^{n-1}$$

Then

$$\frac{\partial h}{\partial t} + c \frac{\partial h}{\partial x} = \frac{dh}{dt} = v-f \quad \text{and} \quad \frac{dx}{dt} = c = n\alpha h^{n-1}$$

or

$$h = \int_{t_1}^t (v-f) dt \quad \text{along a characteristic}$$

$$x - x_1 = n\alpha \int_{t_1}^t h^{n-1} dt.$$

Solution form depends on nature of scale system of interest. Several variations are given.

$$\text{Similarly } H - H_c = 2\alpha \int_{t_1}^t h^n dt$$

$$\text{along } X - X_1 = NA \int_{t_1}^t H^{N-1} dt \quad \text{for streamflow,}$$

with several forms for analytic solutions.

In second part of paper numerical solutions to the characteristic equations are discussed:

$$\frac{dh}{dt} = v - f, \quad \frac{dx}{dt} = nh^{n-1}$$

$$\frac{d}{dt} (\lambda H) = q|_{x=1} \quad \text{and} \quad \frac{d}{dt} (\lambda X) = NH^{N-1}$$

where λ is a dimensionless parameter relating "time constants" for catchment and channel.

Part III applies results to 3 natural catchments. Conclusions:

1. Better geometric description of basins is needed.
2. Lumping small streams into overland flow is necessary for large catchments.
3. Interflow is not included in model but appears to be significant in two of the examples.

208. Amorocho, J., 1966, The nonlinear prediction problem in the study of the runoff cycle. Paper presented at 47th Annual Meeting AGU. Washington, D. C. April.

Nonlinear prediction problem in hydrology involves three elements: 1) Time variability of watersheds (geomorphological evolution); 2) Uncertainty of space and time distributions of input, output and state of the system (values of parameters in space and time); and 3) Inherent nonlinearity of the

processes in the hydrologic cycle.

Time variability may not be significant in many natural processes, but man-made changes can cause significant changes in a short time. Little has been done to study adjustments for such non-stationarity.

The problems related to system uncertainties are compounded by the fact that mathematical models are not identical to the systems they describe, but are only approximately equivalent. Objective optimizing techniques are needed to minimize the probability of the difference between the system output and the model output exceeding the level of tolerance for acceptable models.

The problem of nonlinear analysis has only recently been investigated in depth. A few techniques are discussed including (1) use of Laguerre functions with memory (parallel set) cascaded into no-memory linear systems which are then multiplied to give nonlinear response; and (2) generalization of the convolution integral to give

$$y(t) = \sum_{n=1}^T x^n \int_0^t h_n(\tau_1, \dots, \tau_n) \prod_{i=1}^n [u(t-\tau_i) - u(t-\tau_i-T)] d\tau_1, \dots, d\tau_n$$

where $y(t)$ is output, $u(t)$ is input and $h_n(\tau_1, \dots, \tau_n)$ is the generalized response function. The nonlinear analysis techniques need to be tested and improved.

209. Bell, F. C., 1966, A survey of recent developments in rainfall-runoff estimation. Jour. Inst. Engrs., Australia, Vol. 38: No. 3, 37-48, March.

Current techniques for simulating hydrological phenomena with computers were reviewed. It was suggested that considerably more information of the individual physical processes was known than was being used in these models, and that use of the most current advances would yield better results.

210. Boughton, W. C., 1966, A mathematical model for relating runoff to rainfall with daily data. Institution of Engineers, Australia, Civil Engineering Transactions Vol. CE8: 1, 83-93. April.

Synthesis from component processes with daily values on parameters. Model is intended to generate data for long-term uses where averaging of deviations decreases errors.

Precipitation goes to filling interception storage, upper soil storage (depressions and soil field capacity) and drainage storage (gravity water) in that order. Excess above these stores gives runoff according to

$$Q = P - F \tanh\left(\frac{P}{F}\right) \quad \text{where } P \text{ is excess}$$

rainfall, F is daily infiltration rate and Q is runoff. Use Horton equation $F = F_c + (F_o - F_c)e^{-kS}$ where F_o is dry soil rate, F_c is saturated soil

rate, k is an empirical constant and S is subsoil moisture level. Assumption is that infiltration rate is controlled by a relatively impermeable subsoil that is overlain by a very permeable topsoil. Evapotranspiration occurs from interception storage at potential evapotranspiration rate to empty it. Then soil storages contribute either at the potential rate or at $\frac{H \cdot (\text{soil moisture level})}{(\text{soil moisture capacity})}$ whichever is less.

H = maximum evapotranspiration rate for vegetation on watershed. No ground water contribution in the present model.

211. Chery, D. L., 1966, Design and tests of a physical watershed model. *Jour. of Hydrology*, Vol. 4: 224-235.

Theoretical considerations were discussed, and design criteria and fabrication of a physical hydrologic model of area about 150 sq. ft. (to represent 97.2 acres), including a storm-simulating device were described. As the tests were of an initial character, few useful simulated results were obtained. However, the runs did reveal that comprehensive studies of the liquid-surface interaction were necessary before further modeling was done. Further, investigations into distorted inputs in the length and time scales, and vertical scale distortion of the topographic model required attention.

212. Crawford, N. H. and Linsley, R. K., 1966, Digital simulation in hydrology: Stanford Watershed Model IV, Technical Report No. 39, Dept. of Civil Engineering. Stanford University. July.

Definition of digital simulation and description of the development of simulation models in hydrology (Ch. II). General components of the Stanford model are infiltration, overland flow, evapotranspiration and channel system. Infiltration capacity and evapotranspiration potential are given linear cumulative distributions against % area. Actual amounts are then joint functions of the cumulative distributions and the applied moisture. Overland flow is treated with an empirical modification of the Chezy-Manning

$$\text{eq. : } q = \frac{1.486}{n} S^{1/2} \left(\frac{D}{L}\right)^{2/3} \left(1 + 0.6 \left(\frac{D}{D_e}\right)^3\right)^{1/3}$$

where D_e is an equilibrium flow depth. D/D_e is assumed to be equal to one during recession flow. Channel flow is treated by plotting estimated discharge vs. time for a short (instantaneous) rainfall, neglecting attenuation due to storage. This is modified to represent discharge response from an input of duration equal to the time increment used in the histogram. This histogram is used to delay flows before the flow attenuation is computed. The amount of attenuation can be varied as a function of flow quantity. Detailed descriptions, flowcharts, programs and examples are included.

213. Eagleson, P. S., Mejia-R, R., and March, F., 1966, Computation of optimum realizable unit hydrographs. *Water Resources Research* 2: 4, 755-764.

The problem of determining a stable, physical, realizable linear approximation to the true behavior of a hydrologic runoff system was approached using "black box" analysis. A stable solution was achieved through a least-squares approximation which led to the Wiener-Hopf equations for optimum linear systems. Hydrologically realizable unitgraphs were

secured by obtaining an approximate solution to the equations through linear programming. (See also 1965)

214. Grace, R. A., and Eagleson, P. S., 1966, The use of scale models in rainfall-runoff studies. *Water Resources Research* 2: 3, 393-403.

The communication described the design, construction, and initial verification of a complete 5 ft. square physical model of the rainfall-surface runoff process. The modeling criteria were valid when surface tension effects were negligible, and there was no infiltration.

215. Harbaugh, T. E., 1966, Time distribution of runoff from watersheds. Ph. D. Dissertation, Univ. of Illinois.

A conceptual watershed was formulated on the basis of spatially varied unsteady overland flow. The results of this model were checked with some of the initial experimental runs on the Illinois Laboratory Model, and with data from two watersheds. A measure of watershed roughness was introduced, which included the surface roughness, the raindrop impact, and the variation of each with depth. Shape, length, slope, and roughness of the watershed, as well as storm intensity and duration were the factors studied, and each showed some effect on the time distribution of the runoff.

216. Jacoby, S. L. S., 1966, A mathematical model for nonlinear hydrologic systems, *Journal of Geophysical Research* 71:20, 4811-4824, October.

"Decomposition" model represents nonlinear time-lag systems by a series combination of parallel linear time-lag systems and parallel nonlinear no-time-lag systems. The linear systems are Laguerre systems with output of the m^{th} system given by

$$f_{1m}(t) = \int_0^{\infty} l_m(T) x(t-T) dT \quad m = 0, 1, \dots, n, \dots$$

The subscript 1 on f_{1m} denotes linearity. The nonlinear systems are polynomials. By increasing the number of Laguerre systems and/or polynomial orders, the model output may be made to approach known output to arbitrary accuracy. The price is more computation time.

For computer applications the output of the Laguerre systems is computed for

$$f_{1m}(t_i) \approx \sum_{j=0}^S l_m(T_j) x(t_i - T_j) \Delta T_j$$

where $x(t)$ is input and $l_m(T_j)$ is the normalized Laguerre function. The coefficients of the polynomial systems may be selected by an optimizing criterion such as least squares.

Length of record needed to give model of reasonable quality and degree of nonlinearity of system may be estimated. Example of a 2.33-acre watershed is presented.

217. Machmeier, R. E., 1966, The effect of runoff supply rate and duration on runoff time parameters and peak outflow rates. Ph. D. Dissertation, University of Minnesota.

A mathematical model of an impervious

21. 35 sq. mi. watershed was developed with land and channel characteristics representative of small watersheds in southeastern Minnesota. Equations of momentum and continuity were used to route non-steady flow through a channel system by digital computer. All presently-defined time parameters (i. e. time of concentration, time to equilibrium, time to peak, lag time, etc.) demonstrated a non-linear response to the supply rate. As supply rate increased, the watershed responded more rapidly. The maximum peak flow was shown to occur at some finite duration considerably less than equilibrium. Although a rather strong non-linear effect was observed, similar to that of Amorocho (1963), it was not verified on actual watersheds.

218. O'Donnell, T., 1966, Computer evaluation of catchment behavior and parameters significant in flood hydrology, Ch. 5 of River Flood Hydrology. Institution of Civil Engineers. London.

Broad trends in hydrological research involve two schools of endeavor: (1) comprehensive simulation of catchment behavior, i. e., overall models; and (2) complete specification of each of the elements of catchment behavior.

Examples of digital computer studies are the Stanford Watershed Model, which uses a straightforward bookkeeping procedure to direct fate of rainfall input through the components of the model, and the TVA studies which include analysis procedures to alter model parameters. A modification of the Stanford model to include parameter optimization is presented by the author.

Analog computer models discussed are U. S. G. S. studies presented by Shen, involving routing procedures, and Harder's work on simulation of flood control systems, with oscilloscope trace used for indicating effects of parameter changes to improve agreement with real system.

219. O'Donnell, T., 1966, Methods of computation in hydrograph analysis and synthesis in Recent Trends in Hydrograph Synthesis, Proc. of Technical Meeting 21, Committee for Hydrologic Research T. N. O. pp. 65-103.

Review of models of hydrograph response. Systems considered are linear (time-invariant and time-variant) and nonlinear (synthesis and analysis).

Linear Time-Invariant: Instantaneous unit hydrograph is the "impulse response" of this linear system and convolution transposes excess rainfall into runoff according to the impulse response. Nash and Dooge have cascade models giving conceptual IUH models.

Linear Time-Variant: No published work is known, but author describes his preliminary studies in this area that are not yet of practical use.

Fourier and Laguerre functions have been used for linear system analysis to estimate IUH for time invariant system. TVA uses a least squares fit of $Y = XU$ to find $U = (X^T X)^{-1} X^T Y$.

Nonlinear System Synthesis: Stanford model is the most highly developed model. Parameters are adjusted by operator to fit observed output. Dawdy and O'Donnell have worked on automatic adjustment for parameters of a simple model using a

steepest ascent optimization procedure. There was wide variation in sensitivity of model response to changes in parameter values. High sensitivity leads to rapid convergence while low sensitivity means minor effect that might be omitted from the model.

Nonlinear System Analysis: Amorocho's generalization of the convolution integral has much to be done before it is a practical tool. Standardized procedures are not available. Advantages of non-linear analysis are:

- (1) Freedom from subjective bias about system
- (2) System need not have continuity on input, output and storage. Observed rainfall and runoff can be used without accounting for evapotranspiration, etc.

220. Pilgrim, D. H., 1966, Radioactive tracing of storm runoff on a small catchment. Jour. of Hydrology Vol. 4: 289-326.

The tracing of storm runoff on a 96 acre natural catchment by means of radioactive tracers was described, and the results were discussed. Measured values of the time of travel from the most remote point to the outlet depended on discharge and the duration of rainfall excess. As discharge increased, the time of concentration decreased rapidly from very high values at low discharges and reached a fairly constant value at medium to high discharges. Short bursts of rainfall excess producing discrete flood waves tended to give higher flow velocities; whereas, longer periods of rainfall excess producing similar peak flows but under conditions approaching steady flow tended to give lower velocities. Comments were also given regarding the validity of linear analysis, an apparent partial area runoff production effect, and the distribution of initial loss.

The results indicate that tracing can provide a unique type of information concerning several aspects of the storm runoff process.

221. Rosa, J. M., 1966, An electric analog for computing direct surface runoff. U. S. Dept. of Agr., ARS 41-118, April.

The purpose of the study was to demonstrate the feasibility of an electric analog device for routing runoff in order to generate hydrographs. A very inexpensive model was constructed and used for simulation. The results were promising.

222. Schulze, F. E., 1966, Rainfall and rainfall excess in Recent Trends in Hydrograph Synthesis, Proc. of Technical Meeting 21, Committee For Hydrologic Research T. N. O. pp. 9-30.

Rainfall /rainfall excess relationships are reviewed. Models in which losses are not independent of the rainfall excess /outflow hydrograph relationship are not considered.

Bookkeeping or threshold methods are strongly related to physical soil properties, esp. moisture holding capacity. In general, $Q = P - d$, where Q is excess rainfall, P is precipitation and d is moisture deficit. Variations among methods are in determining evapotranspiration rate and consequent deficit at start of rainfall. Apply when most excess moves by subsurface flow.

Infiltration approaches are appropriate to

conditions where excess rainfall moves primarily as surface flow. Horton used

$$f = f_c + (f_o - f_c) e^{-kt}$$

Holtan used $f - f_c = aF_p$, where F_p is remaining potential storage, which can be used even if precipitation rate is less than infiltration rate at times during storm. Methods require estimate of initial infiltration capacity rate.

Functional relationships are used to avoid problem of no runoff until deficit is removed. Curved sections join origin or initial loss point and asymptotic approach to linear relation between P and Q.

Combinations of above concepts have been made by using, for example, accounting procedures to estimate initial infiltration rates.

When initial infiltration capacity estimates are obtained by correlation analysis (e. g., with API), it is preferable to correlate directly with the rainfall excess. (I. e., $Q = F(P, API)$ instead of $d = f(API)$ and $Q = F(P, d)$.)

223. Willeke, Gene E., 1966, Time in urban hydrology, Proc. A. S. C. E. 93: HY1, 13-30, January.

Hydrographs were synthesized by determining the effective precipitation, by using phi-index, and routing it by Muskingum method with $x = 0$ and $K = \text{lag time}$.

Coefficients of variation for lag times ranged from 10% to 43% with a mean of 29%. Only low correlation appeared between storm parameters (5-min. average intensity and total effective precipitation) and lag time, so it was concluded that only weak relationship exists, or none at all.

Loss of precipitation had the following relation to slope: $L = 0.162 - 0.039i$ with standard error ~ 0.02 in. Negative coefficient for slope (in percent) may be related to reduced depression storage.

Conclusions: accurate reproduction of recorded hydrographs supports hypothesis that storage characteristics of small urban watersheds are accurately represented by basin lag and that storage

system is pure reservoir type. Data collection and instrumentation need more consideration and work.

224. Wooding, R. A., 1966, A hydraulic model for the catchment-stream problem: part III. Journal of Hydrology 4:21 (1966)

See Wooding, R. A., 1965.

225. Bell, F. C., 1967, An alternate physical approach to watershed analysis and streamflow estimation, International Hydrology Symposium, Fort Collins, Colorado, September.

A system of watershed concepts was introduced with a general "retention theory", which included infiltration theory as a special case. The retention theory provides for inter-relations between hydrologic processes with mathematical expression of (a) watershed condition, reflecting parameters which varied continuously within each watershed and express its relevant moisture status or condition at any particular time, and (b) "watershed function", relating to parameters which remained relatively constant for each watershed.

226. Prasad, Ramanand, 1967, A nonlinear hydrologic system response model, Proc. A. S. C. E. 93: HY4, 201-221. July.

A nonlinear reservoir has storage $S = D' Y^g$ where D' and g are constants and Y is stage or water level. For stage-discharge relation $Q = C Y^M$, we have $S = K_1 Q^N$ with $K_1 = D' / C^N$ and $N = g/M$. Allowing for unsteady flow effects and continuity leads to

$$K_2 \frac{d^2 Q}{dt^2} + K_1 N Q^{N-1} \frac{dQ}{dt} + Q = R$$

where R is input and Q is output. This second-order nonlinear differential equation can be solved with analog or digital computer methods.

The equation parameters N , K_1 and K_2 were correlated with basin and rainfall excess characteristics by stepwise multiple correlation techniques.

INDEX BY AUTHORS

[This index by authors refers to the numbers of the reference in the chronological bibliography. Where there are two or more authors, each reference is indexed under the names of all coauthors. Multiple authorship is indicated by an asterisk before the identifying number of the reference]

- Ackermann, W. C., 59 (1942).
 Amorocho, J., 144 (1961), *145 (1961), *146 (1961),
 173 (1963), *186 (1964), 208 (1966).
 Andrews, R. G., *151 (1961).
 Appleby, F. V., 95 (1954).
 Augustine, M. T., 62 (1943).
 Ayers, H. D., 156 (1962), *199 (1965).
 Barnes, B. S., 28 (1939), 35 (1940), 54 (1942), 90
 (1952), 122 (1959).
 Barrows, H. K., 55 (1942).
 Befani, A. N., 130 (1960).
 Behlke, C. E., 112 (1957).
 Bell, F. C., 209 (1966), 225 (1967).
 Bender, D. L., *147 (1961).
 Bernard, M. M., 12 (1935), 14 (1936).
 Betson, R. P., 187 (1964).
 Beyers, L. A., 169 (1962).
 Body, D. N., *155 (1961), 157 (1962), *158 (1962).
 Boston Soc. Civil Engrs., 5 (1930)
 Boughton, W. C., 210 (1966).
 Brater, E. F., 29 (1939), *51 (1941), *129 (1959).
 Burdoin, A. J., *53 (1941).
 Butler, S. S., 113 (1957).
 Chen, Cheng-lung, 159 (1962).
 Chen, M. C., 131 (1960).
 Chery, D. L., 211 (1966).
 Chow, V. T., 103 (1956), 160 (1962), 161 (1962),
 188 (1964).
 Clark, C. O., 36 (1940), 73 (1945).
 Cochran, A. L., *74 (1945).
 Collins, W. T., 30 (1939).
 Commons, G. G., 56 (1942).
 Cook, H. L., *9 (1933).
 Crawford, N. H., *133 (1960), *162 (1962), *174
 (1963), 197 (1965), *212 (1966).
 Cross, W. P., *81 (1949).
 Cuenod, M., 104 (1956).
 Dawdy, D. R., 198 (1965).
 Delleur, J. W., *196 (1964).
 Dickinson, W. T., 175 (1963), *199 (1965).
 Diskin, M. H., *196 (1964), 200 (1965).
 Dooge, J. C. I., 100 (1955), 105 (1956), 114 (1957),
 123 (1959).
 Eagleson, P. S., 163 (1962), *201 (1965), *203 (1965),
 *205 (1965), *213 (1966), *214 (1966).
 Eaton, T. D., 96 (1954).
 Edson, C. G., 86 (1951).
 Fekete, P. H., 97 (1954).
 Flynt, F. L., *16 (1936).
 Folse, J. A., 3 (1929), 15 (1936).
 Getty, H. C. *164 (1962).
 Geyer, J. C. *170 (1962).
 Gibbs, A. E., *142 (1960).
 Grace, R. A., *214 (1966).
 Gray, D. M., 148 (1961), 149 (1961).
 Guthe, O. E., *46, (1941).
 Harbaugh, T. E., 215 (1966).
 Harris, B., *142 (1960).
 Hart, W. E. *186 (1964).
 Hathaway, G. A., 47 (1941), *74 (1945), 75 (1945).
 Henderson, F. M., 176 (1963), *189 (1964).
 Hertzler, R. A., 31 (1939).
 Hickok, R. B., *124 (1959).
 Hicks, W. I., 57 (1942), 66 (1944).
 Hideo, Kikkawa, *99 (1954).
 Holtan, H. N., 76 (1945), *177 (1963).
 Horner, W. W., *16 (1936), 37 (1940), *58 (1942),
 67 (1944).
 Horton, R. E., 8 (1933), *9 (1933), 13 (1935), 17
 (1936), 18 (1936), 21 (1937), 23 (1938), 48 (1941),
 49 (1941).
 Houk, I. E., 1 (1921).
 Howland, W. E., 77 (1945).
 Hoyt, W. G., *19 (1936), 38 (1940), 50 (1941), 80
 (1949).
 Hullinghorst, D. W., *32 (1939).
 Hursh, C. R., *51 (1941).
 Iwasaki, T., 10 (1934).
 Izzard, C. F., *62 (1943), 68 (1944).
 Jacoby, S. L. S., 216 (1966).
 Jacquet, J., 132 (1960).
 Jarocki, Walenty, 94 (1963).
 Jens, S. W., *58 (1942).
 Jetter, K., 69 (1944).
 Johnson, S. M., *166 (1962).
 Johnstone, D., *81 (1949).
 Keifer, C. J., *143 (1960), 150 (1961).
 Keppel, R. V., *124 (1959).
 Keulegran, G. H., 70 (1944).
 Kinji, Shinohara, *118 (1958).
 Kirpich, Z. P., 39 (1940).
 Kishi, Tsutoma, 178 (1963).
 Kleen, M. H., *151 (1961), 190 (1964).
 Kohler, M. A., *82 (1949), *87 (1951), *119 (1958),
 179 (1963).
 Koyo, Tatsugami, 202 (1965).
 Kulandaiswamy, V. C., 191 (1964).
 Laden, N. R., *40 (1940).
 Langbein, W. B., 24 (1938), 41 (1940).
 Laurenson, E. M., 165 (1962), 180 (1963), 192 (1964).
 Leach, H. R., *9 (1933).
 Lenz, A. T. *71 (1944).
 Lienhard, J. H., 193 (1964).
 Liggett, J. A., 125 (1959).

Linsley, R. K., Jr., 59 (1942), 63 (1943), *82 (1949)
*87 (1951), *119 (1958), *133 (1960), *162 (1962),
*174 (1963), *204 (1965), *212 (1966).
Lucas, R. B., 83 (1949).
Machmeier, R. E., 217 (1966).
March, F., *201 (1965), *203 (1965), *213 (1966).
Maruyama, F., *106 (1956).
McCarthy, G. T., 25 (1938).
McHughes, J. H., *164 (1962).
Meinzer, O. E., *4 (1929).
Mejia-R. R., *201 (1965), *213 (1966).
Merriam, C. F., 60 (1942), 88 (1951).
Meyer, O. H., 42 (1940).
Minnotte, J. S., *40 (1940).
Minshall, N. E., 134 (1960).
Mitchell, W. D., 79 (1948).
Mockus, V., 115 (1957).
Morgali, J. R., *204 (1965).
Morgan, P. E., *166 (1962).
Morgan, R., *32 (1939).
Morris, W. V., 126 (1959).
Nash, J. E., 116 (1957), 120 (1958), 127 (1959), 135
(1960), 136 (1960).
Oakes, C. K., 152 (1961).
O'Donnell, T., 137 (1960), 198 (1965), 218 (1966),
219 (1966).
Ogrosky, H. O., 167 (1962).
O'Kelley, J. J., 101 (1955).
Orlob, G. T., *145 (1961), *146 (1961).
Overton, D. E., *177 (1963).
Owen, J. C., *46 (1941).
Owen, W. J., *142 (1960).
Parsons, W. J., 72 (1944).
Paulhus, J. L. H., *82 (1949), *119 (1958).
Paynter, H. M., 91 (1952).
Pettis, C. R., 26 (1938).
Pilgrim, D. H., 220 (1966).
Prasad, Ramanand, 226 (1967).
Rafferty, B. R., 124 (1959).
Rainbird, A. F., 153 (1961).
Ramaseshan, S., 194 (1964).
Reich, B. M., 138 (1960), 168 (1962).
Reilley, T. L. *40 (1940).
Remenieras, G., 139 (1960).
Restrepo, J. C. O., *205 (1965).
Richey, E. P., 98 (1954).
Riggs, H. C., 140 (1960).

Roberson, J. A., *147 (1961).
Robinson, A. D., *169 (1962).
Roche, M., 181 (1963).
Rodier, J., 141 (1960).
Rodriguez-Iturbe, I., 206 (1965).
Rosa, J. M., 221 (1966).
Ross, C. N., 2 (1921).
Sawyer, C. N., *71 (1944).
Schulze, F. E., 222 (1966).
Schwarz, H. E., *92 (1952).
Seiichi, Sato, *99 (1954).
Sharp, A. L., *142 (1960).
Sherman, L. K., 6 (1932), 7 (1932), 43 (1940), 44
(1940), 84 (1949).
Singh, K. P., 195 (1964).
Smith, Waldo E., 52 (1941), 61 (1942).
Snyder, F. F., 27 (1938), 33 (1939), 45 (1940), 64
(1943).
Snyder, W. M., 102, (1955).
Soong, Yu-Chek, 85 (1950).
Stearns, N. D., *4 (1929).
Sugawara, M., *106 (1956).
Taylor, A. B., *92 (1952).
Tholin, A. L., *143 (1960).
Tojiro, Ishihara, *107 (1956), 121 (1958).
Toshihiko, Ueda, *118 (1958).
Toshimitsu, Kimura, *99 (1954), 108 (1956).
Turner, H. M., *53 (1941), 65 (1943).
U. S. Army Corps of Engineers, 128 (1959), 182
(1963).
U. S. Dept. of Agriculture, 117 (1957).
Viessman, W., *170 (1962).
Villares, A. M., 109 (1956).
Warnock, R. G., 93 (1952).
Watkins, L. H., 89 (1951), 110 (1956), 183 (1963),
184 (1963).
Watson, B., 154 (1961), *155 (1961), *158 (1962),
171 (1962).
Willeke, Gene E., 223 (1966).
Williams, H. M., 78 (1945).
Wisler, C. O., *129 (1959).
Woo, Dah-Cheng, 172 (1962).
Wooding, R. A., *189 (1964), 207 (1965), 224 (1966).
Wu, I-Pai, 185 (1963), *196 (1964).
Yonezo, Nakayasu, 111 (1956).
Zoch, R. T., 11 (1934), 20 (1936), 22 (1937), 34
(1939).

INDEX OF SUBJECTS

[This index is based on the abstracts in the chronological bibliography and not on the original text in the references. The index is not comprehensive; only the major concepts are included in the index. General descriptors were used primarily when more specific ones could not be determined. Thus in using the index, refer to the specific descriptors first.]

- Antecedent moisture . . . 3, 155
- Bank storage . . . 44
- Channel storage . . . 13, 17, 21, 24, 41, 42, 48, 49, 65
- Correlation and regression on watershed parameters . . . 3, 10, 140, 142, 145, 153, 168
- Differential and difference equation methods . . . 95, 98, 125, 130, 178, 188, 207, 224
- Dimensionless hydrographs . . . 56, 78, 117, 124, 147, 149, 151, 167, 193, 204
- Distribution graph . . . 12, 14, 26, 29, 30, 40, 52, 69, 84, 93, 151
- Evapotranspiration . . . 3, 22, 59, 190
- Flood routing in channels . . . 47, 123, 125, 154, 216, 221
- Graphical methods . . . 13, 87, 115, 117, 169
- Ground water . . . 33, 60
- Hydrograph analysis . . . 102, 137, 191, 194, 201, 203, 205, 213
- Hydrograph separation . . . 1, 3, 4, 5, 8, 19, 28, 33, 44, 45, 51, 54, 59, 71, 76, 87, 88, 128, 175
- Hydrograph synthesis . . . 13, 36, 42, 66, 78, 115, 117, 124, 148, 170, 171, 177, 223
- Infiltration . . . 8, 13, 30, 33, 37, 58, 67, 76, 107, 186, 190, 225
- Instantaneous unit hydrograph . . . 5, 20, 41, 73, 91, 114, 116, 127, 135, 136, 137, 176, 180, 195, 201, 203, 205, 213
- Least squares fitting . . . 102, 201, 205, 213
- Models, analog and physical . . . 95, 169, 200, 211, 214
- Nonlinear analysis . . . 146, 173, 208, 216
- Nonlinear response . . . 91, 186, 195, 217
- Overland flow . . . 18, 23, 57, 58, 62, 68, 70, 75, 77, 112, 159, 170, 172, 204, 215
- Recession curves . . . 35, 51, 58, 59, 72, 74, 88, 177
- Reservoir, linear . . . 53, 73, 101, 105, 110, 123
- Reservoir, non linear . . . 179, 191, 192, 226
- Review of methods . . . 19, 74, 89, 90, 94, 103, 120, 138, 152, 156, 161, 185, 189, 206, 209, 218, 219, 222
- Runoff functions . . . 9, 10, 67, 121, 168, 169, 195, 200
- S - curve . . . 32, 40, 41, 74, 104
- Storage . . . 11, 13, 19, 20, 36, 43, 46, 55, 61, 62, 65, 67, 72, 86, 100, 106, 108, 114, 116, 157, 165, 182, 183
- Synthesis models . . . 133, 143, 150, 162, 174, 197, 198, 209, 210, 212, 217
- Synthetic unit hydrograph . . . 25, 27, 40, 46, 74, 79, 83, 90, 92, 96, 105, 109, 111, 128, 134, 144, 147, 149, 160, 164, 166
- Systems analysis . . . 91, 137, 146, 201, 203, 205, 213
- Textbooks and handbooks . . . 81, 82, 113, 119, 129, 181, 187
- Time-area diagram . . . 2, 86, 101, 110, 123, 182, 183, 202
- Time-area-concentration diagram . . . 20, 42, 48, 53, 73
- Time-of-concentration . . . 5, 39, 42, 57, 110
- Unit hydrograph . . . 5, 6, 7, 12, 14, 15, 16, 19, 26, 29, 32, 35, 43, 44, 45, 47, 63, 64, 74, 75, 77, 79, 84, 85, 89, 90, 97, 99, 100, 101, 104, 106, 107, 118, 120, 122, 123, 126, 128, 132, 139, 141, 155, 157, 158, 159, 163, 175, 176, 180, 181, 199, 202
- Urban runoff . . . 16, 58, 66, 163, 170, 222
- Unit hydrograph and watershed parameters . . . 7, 12, 25, 29, 31, 69, 83, 86, 92, 93, 124, 127, 131, 135, 136, 148, 149, 184, 196, 215, 220, 225

Key Words: Watershed response, artificial storms, rainfall-runoff relationships, small watersheds, erosion, water pollution.

Abstract: Part I. An experimental facility is described for the investigation of the rainfall-runoff relationship. Large enough to respond as a prototype watershed, but small enough to permit controlled variation of watershed characteristics and artificial application of rainfall. The criteria for the facility are related to (1) control of rainfall, which should be reproducible and reasonably uniform, (2) measurement of variables, with attention to variations in time and space, and (3) variation of watershed parameters. The experimental facility has potential application in studies of rainfall-runoff response, erosion, and travel of pollutants on watersheds. It serves to contract time and space in generating runoff events and is applicable to studies of individual runoff processes and to evaluation of mathematical and physical models of watershed response. Part II. The design and construction of the rainfall-runoff experimental facility is described. Three phases are discussed: (1) site selection, (2) selection of basic geometry of facility, and (3) design and construction techniques of site preparation, methods of precipitation and discharge measurement with automatic digital recording of data, soil surface treatment, and proposed precipitation towers. Part III. A review and appraisal of the status of mathematical models of hydrologic watershed response is followed by an annotated bibliography of 226 references relating studies of watershed response.

Reference: W. T. Dickinson, M. E. Holland and G. L. Smith, Colorado State University Hydrology Paper No. 25 (September 1967), "An Experimental Rainfall-Runoff Facility."

Key Words: Watershed response, artificial storms, rainfall-runoff relationships, small watersheds, erosion, water pollution.

Abstract: Part I. An experimental facility is described for the investigation of the rainfall-runoff relationship. Large enough to respond as a prototype watershed, but small enough to permit controlled variation of watershed characteristics and artificial application of rainfall. The criteria for the facility are related to (1) control of rainfall, which should be reproducible and reasonably uniform, (2) measurement of variables, with attention to variations in time and space, and (3) variation of watershed parameters. The experimental facility has potential application in studies of rainfall-runoff response, erosion, and travel of pollutants on watersheds. It serves to contract time and space in generating runoff events and is applicable to studies of individual runoff processes and to evaluation of mathematical and physical models of watershed response. Part II. The design and construction of the rainfall-runoff experimental facility is described. Three phases are discussed: (1) site selection, (2) selection of basic geometry of facility, and (3) design and construction techniques of site preparation, methods of precipitation and discharge measurement with automatic digital recording of data, soil surface treatment, and proposed precipitation towers. Part III. A review and appraisal of the status of mathematical models of hydrologic watershed response is followed by an annotated bibliography of 226 references relating studies of watershed response.

Reference: W. T. Dickinson, M. E. Holland and G. L. Smith, Colorado State University Hydrology Paper No. 25 (September 1967), "An Experimental Rainfall-Runoff Facility."

Key Words: Watershed response, artificial storms, rainfall-runoff relationships, small watersheds, erosion, water pollution.

Abstract: Part I. An experimental facility is described for the investigation of the rainfall-runoff relationship. Large enough to respond as a prototype watershed, but small enough to permit controlled variation of watershed characteristics and artificial application of rainfall. The criteria for the facility are related to (1) control of rainfall, which should be reproducible and reasonably uniform, (2) measurement of variables, with attention to variations in time and space, and (3) variation of watershed parameters. The experimental facility has potential application in studies of rainfall-runoff response, erosion, and travel of pollutants on watersheds. It serves to contract time and space in generating runoff events and is applicable to studies of individual runoff processes and to evaluation of mathematical and physical models of watershed response. Part II. The design and construction of the rainfall-runoff experimental facility is described. Three phases are discussed: (1) site selection, (2) selection of basic geometry of facility, and (3) design and construction techniques of site preparation, methods of precipitation and discharge measurement with automatic digital recording of data, soil surface treatment, and proposed precipitation towers. Part III. A review and appraisal of the status of mathematical models of hydrologic watershed response is followed by an annotated bibliography of 226 references relating studies of watershed response.

Reference: W. T. Dickinson, M. E. Holland and G. L. Smith, Colorado State University Hydrology Paper No. 25 (September 1967), "An Experimental Rainfall-Runoff Facility."

Key Words: Watershed response, artificial storms, rainfall-runoff relationships, small watersheds, erosion, water pollution.

Abstract: Part I. An experimental facility is described for the investigation of the rainfall-runoff relationship. Large enough to respond as a prototype watershed, but small enough to permit controlled variation of watershed characteristics and artificial application of rainfall. The criteria for the facility are related to (1) control of rainfall, which should be reproducible and reasonably uniform, (2) measurement of variables, with attention to variations in time and space, and (3) variation of watershed parameters. The experimental facility has potential application in studies of rainfall-runoff response, erosion, and travel of pollutants on watersheds. It serves to contract time and space in generating runoff events and is applicable to studies of individual runoff processes and to evaluation of mathematical and physical models of watershed response. Part II. The design and construction of the rainfall-runoff experimental facility is described. Three phases are discussed: (1) site selection, (2) selection of basic geometry of facility, and (3) design and construction techniques of site preparation, methods of precipitation and discharge measurement with automatic digital recording of data, soil surface treatment, and proposed precipitation towers. Part III. A review and appraisal of the status of mathematical models of hydrologic watershed response is followed by an annotated bibliography of 226 references relating studies of watershed response.

Reference: W. T. Dickinson, M. E. Holland and G. L. Smith, Colorado State University Hydrology Paper No. 25 (September 1967), "An Experimental Rainfall-Runoff Facility."

PREVIOUSLY PUBLISHED PAPERS

Colorado State University Hydrology Papers

- No. 15 "Mathematical Models for Time Series of Monthly Precipitation and Monthly Runoff," by L. A. Roesner and V. Yevjevich, October 1966.
- No. 16 "Statistical Evaluation of Weather Modification Attainments," by Radmilo D. Markovic, November 1966.
- No. 17 "Properties of Unsaturated Porous Media, by G. E. Laliberte, A. T. Corey, and R. H. Brooks, November 1966.
- No. 18 "Stochastic Model of Daily River Flow Sequences," by Rafael G. Quimpo, February 1967.
- No. 19 "Engineering Judgment and Small Area Flood Peaks, by Lourens A. V. Hiemstra and Brian M. Reich, April 1967.
- No. 20 "Accuracy of Discharge Determinations," by W. T. Dickinson, June 1967.
- No. 21 "Water Quality of Mountain Watersheds," by Samuel H. Kunkle and James R. Meiman, June 1967.
- No. 22 "Prediction of Water Yield in High Mountain Watersheds Based on Physiography," by Robert W. Julian, Vujica Yevjevich, and Hubert J. Morel-Seytoux, August 1967.
- No. 23 "An Objective Approach to Definitions and Investigations of Continental Hydrologic Droughts," by Vujica Yevjevich, August 1967.
- No. 24 "Application of Cross-Spectral Analysis to Hydrologic Time Series, Ignacio Rodriguez - Iturbe, September 1967.

Colorado State University Fluid Mechanics Papers

- No. 4 "Experiment on Wind Generated Waves on the Water Surface of a Laboratory Channel," by E. J. Plate and C. S. Yang, February 1966.
- No. 5 "Investigations of the Thermally Stratified Boundary Layer," by E. J. Plate and C. W. Lin, February 1966.
- No. 6 "Atmospheric Diffusion in the Earth's Boundary Layer--Diffusion in the Vertical Direction and Effects of the Thermal Stratification," by Shozo Ito, February 1966.

Colorado State University Hydraulics Papers

- No. 1 "Design of Conveyance Channels in Alluvial Materials," by D. B. Simons, March 1966.
- No. 2 "Diffusion of Slot Jets with Finite Orifice Length-Width Ratios," by V. Yevjevich, March 1966.