

Environmental Geology 9

Coal Mine Subsidence and Land Use in the Boulder–Weld Coalfield, Boulder and Weld Counties, Colorado

By

Amuedo and Ivey

A. R. Myers, J. B. Hansen, R. A. Lindvall, J. B. Ivey, and J. L. Hynes



Colorado Geological Survey
Department of Natural Resources
Denver, Colorado
1975

COAL MINE SUBSIDENCE AND LAND USE IN THE
BOULDER-WELD COALFIELD
BOULDER AND WELD COUNTIES, COLORADO

Prepared for
THE COLORADO GEOLOGICAL SURVEY

By

AMUEDO AND IVEY

A. R. Myers, J. B. Hansen, R. A. Lindvall,
J. B. Ivey, and J. L. Hynes

THIS RESEARCH WAS FUNDED IN PART BY THE UNITED STATES
DEPARTMENT OF INTERIOR, BUREAU OF MINES THROUGH GRANT
NO. G0244001, AND IN PART BY WELD COUNTY.

March, 1975

INTERIM TEXT FOR ENVIRONMENTAL GEOLOGY NO. 9

The final published text for Environmental Geology No. 9 is currently being finalized and will not be available until mid-1977. Because the text is essential to the understanding of the maps, we are providing this duplicated copy of the basic text of the report as an interim measure. Photographic figures in the duplicated copy are of poor quality but will appear as normal halftones in the final version. The final text will also contain a foreward by the Colorado Geological Survey on applicability of the study to HB 1041 with suggestions for more precise evaluation of the hazard when development of undermined land is proposed. There will also be an added appendix updating information on the maps at a few locations. Holders of this interim text may exchange it at our office for the final version at no additional cost when it becomes available.

William P. Rogers, Chief
Engineering and Environmental
Geology Section
Colorado Geological Survey

The Colorado Geological Survey is an equal opportunity employer.

FOREWORD

The problem of subsidence resulting from the undermining of the surface has received a great deal of study over the past 100 years. Much of this work has been done in Europe where industry, population density, and coal mining tended to grow and develop in the same areas. Damage to surface structures in highly urbanized areas such as the Ruhr and the English Midlands led to intensive investigations as to how to predict where and when subsidence would occur and how to prevent or minimize such subsidence. Until recently most of the significant research on surface subsidence was done abroad and has been published in journals which are not easily obtainable or are in a language other than English.

In Europe, most underground coal mining is done by methods different than those commonly used in the Boulder-Weld coalfield. For this reason, one must be cautious in applying European theories of subsidence prediction to the Boulder-Weld coalfield where the layout and condition of the mines are quite different.

In the last decade, land development has encroached on the undermined areas of the Boulder-Weld coalfield, and the importance of subsidence has been recognized. This study is directed primarily toward the problems of land-use in those undermined areas where subsidence has occurred in the past and may occur in the future. Absolute predictability of the amount and area of subsidence in the Boulder-Weld coalfield is not possible with the records now available.

In Europe land-use plans have evolved to take subsidence into account, and detailed records have been maintained over long periods of time. It is unfortunate that the level of record-keeping in the Boulder-Weld coalfield has not been geared to land-use needs, because the present lack of data severely limits the accuracy of subsidence prediction. Within the limitations imposed by the adequacy of mine data, this study is intended to bring together a body of information that will be useful to planners and geologists involved in bringing the land to its optimum use.

TABLE OF CONTENTS

	<u>Page No.</u>
I. SUMMARY	1
II. INTRODUCTION AND GENERAL DESCRIPTION OF PROJECT	5
Purpose and Scope of Study	5
Location, Size, and Accessibility of Area	5
Maps and Photos	6
Previous Studies	8
Acknowledgments	8
III. GENERAL GEOLOGY	11
Stratigraphy	11
Fox Hills Sandstone	11
Laramie Formation	13
Quaternary Deposits	15
Structure	16
Physical Characteristics of the Geologic Section	17
IV. REVIEW OF COAL MINE SUBSIDENCE THEORY AND APPLICATION TO BOULDER-WELD COALFIELD	21
Basic Framework of Subsidence Problem	21
Subsidence Model	22
Subsidence in the Boulder-Weld Coalfield	25
V. BASIC DATA MAPS - CONSTRUCTION AND ANALYSIS	27
Extent-of-Mining Map	27
Depth-of-Cover Map	30
Mine-Pillars Map	33
Probable-Thickness-of-Extracted-Coal Map	35
Subsidence-Inventory Map	37
VI. FIELD WORK	53
VII. SPECIAL PURPOSE ACTIVITIES	55
Photogeologic Review	55
Comparison of 1949 and 1969 Aerial Photography	58
Low-sun-angle Photography	59

TABLE OF CONTENTS (Cont.)

	<u>Page No.</u>
VIII. LAND-USE PLANNING AND MINE SUBSIDENCE	65
Background	65
Subsidence-Hazard Map	67
Purpose and Procedures	67
Basic Assumptions Used in Map Construction	70
Hazard Classification System	71
Safety Factor	74
Reclassification of Subsidence Hazard of Specific Areas	75
Planning Review of Subsidence Hazards of Specific Areas	75
IX. CONCLUSIONS	77
X. SELECTED REFERENCES	81
APPENDIX A City, County, State, and Federal Officials; Miners; Local Residents and Others Interviewed During Coal Mine Subsidence Study	85

LIST OF ILLUSTRATIONS

FIGURES

		PAGE
Figure 1.	Location map Boulder-Weld Coalfield	3
Figure 2.	Index map of U. S. Geological Survey 7 1/2' quadrangle maps	7
Figure 3.	Generalized columnar section Boulder-Weld Coalfield	12
Figure 4.	Subsidence trough before mining reaches critical width	23
Figure 5.	Subsidence trough after mining reaches critical width	24
Figure 6.	Stereo triplet of Marshall area	28
Figure 7.	Collapse over room of Marshall No. 1 mine	38
Figure 8.	Collapse area over Lewis No. 1 and No. 2 mines	38
Figure 9.	Collapse over room of Lewis No. 1 mine	39
Figure 10.	Recent subsidence over Lewis No. 1 and No. 2 mines	39
Figure 11.	Large subsidence pit over the Premier mine	40
Figure 12.	Large, well-developed subsidence pits over rooms of the Shanahan mine	40
Figure 13.	Collapse pit over the Allen Bond mine	41
Figure 14.	Numerous subsidence pits above an unreported mine	41
Figure 15.	Water-filled depression over Nonpariel mine	43

LIST OF ILLUSTRATIONS (Cont.)

	PAGE
Figure 16. Broad swale over Lincoln mine	43
Figure 17. Broad sag over Morrison mine	44
Figure 18. Water-filled depression just east of Russell mine	44
Figure 19. Sand dune area one-half mile west of Firestone	45
Figure 20. Subsidence over Strathmore mine, South Longmont Street, Lafayette	45
Figure 21. Subsidence over Strathmore mine, South Longmont Street, Lafayette	46
Figure 22. Front stoop of house to the right in Figure 21	46
Figure 23. Subsidence pit at a trailer court in Lafayette	47
Figure 24. Detail of subsidence pit at trailer court in Lafayette	48
Figure 25. Garage over Black Diamond mine	49
Figure 26. Detail of garage shown in Figure 25	49
Figure 27. Damage to VFW hall, Main Street, Louisville	50
Figure 28. Abandoned building, Main Street, Louisville	50
Figure 29. A.S.C.S. photo of area A, south of Marshall, high-sun-angle photo	60
Figure 30. U.S.G.S. photo of area A, south of Marshall, low-sun-angle photo	60
Figure 31. A.S.C.S. photo of area B, north of Marshall, high-sun-angle photo	61

LIST OF ILLUSTRATIONS (Cont.)

		<u>Following Page</u>
Figure 32.	U.S.G.S. photo of area B, north of Marshall, low-sun-angle photo	61

DRAWINGS
(In Pocket)

7361-1	Extent of Mining Map	
7361-2	Depth of Cover Map	
7361-3	Mine Pillars Map	
7361-4	Probable Thickness of Extracted Coal Map	
7361-5	Subsidence Inventory Map	
7361-6	Subsidence Hazard Map	

Blank

I. SUMMARY

This study is intended primarily to provide basic data concerning mine subsidence to local and state planners. It is also intended that other investigators preparing more detailed studies of specific areas can use this data. The project is not an exhaustive treatment of mine subsidence. Rather, it focuses on basic, subsidence-related problems and on practical approaches to land development in the project area.

The purpose of this study is to define the extent of mining as accurately as possible, commensurate with the scale of the final maps, and to define the physical factors controlling subsidence. Such factors include the extent of pillar removal, the thickness of extracted coal, the depth of cover above mine workings, and the times of mine operations.

The scope of this study is confined primarily to a review of existing data, a limited amount of field work, and the preparation of this report. Maps, tables, and photographs illustrating the findings of the study are presented. Techniques such as low-sun-angle photography and aerial photo interpretation have been examined as possible tools to be used in subsidence studies.

The most important product of this study is a subsidence hazard map which shows the degree of subsidence severity which

can be expected over the various undermined areas. State and local planners and land developers will find this map particularly useful in making initial judgements about the feasibility of projects within the coalfield.

Prior to the design stage of many projects, it will be necessary to gather additional information on the subsidence hazards of specific properties. This information will be mainly obtained from core drilling and geophysical surveys, and its acquisition is likely to be expensive. It is believed that, despite the increased costs and problems brought on by undermining, development in the Boulder-Weld coalfield can be undertaken provided that good design and planning practices are followed.

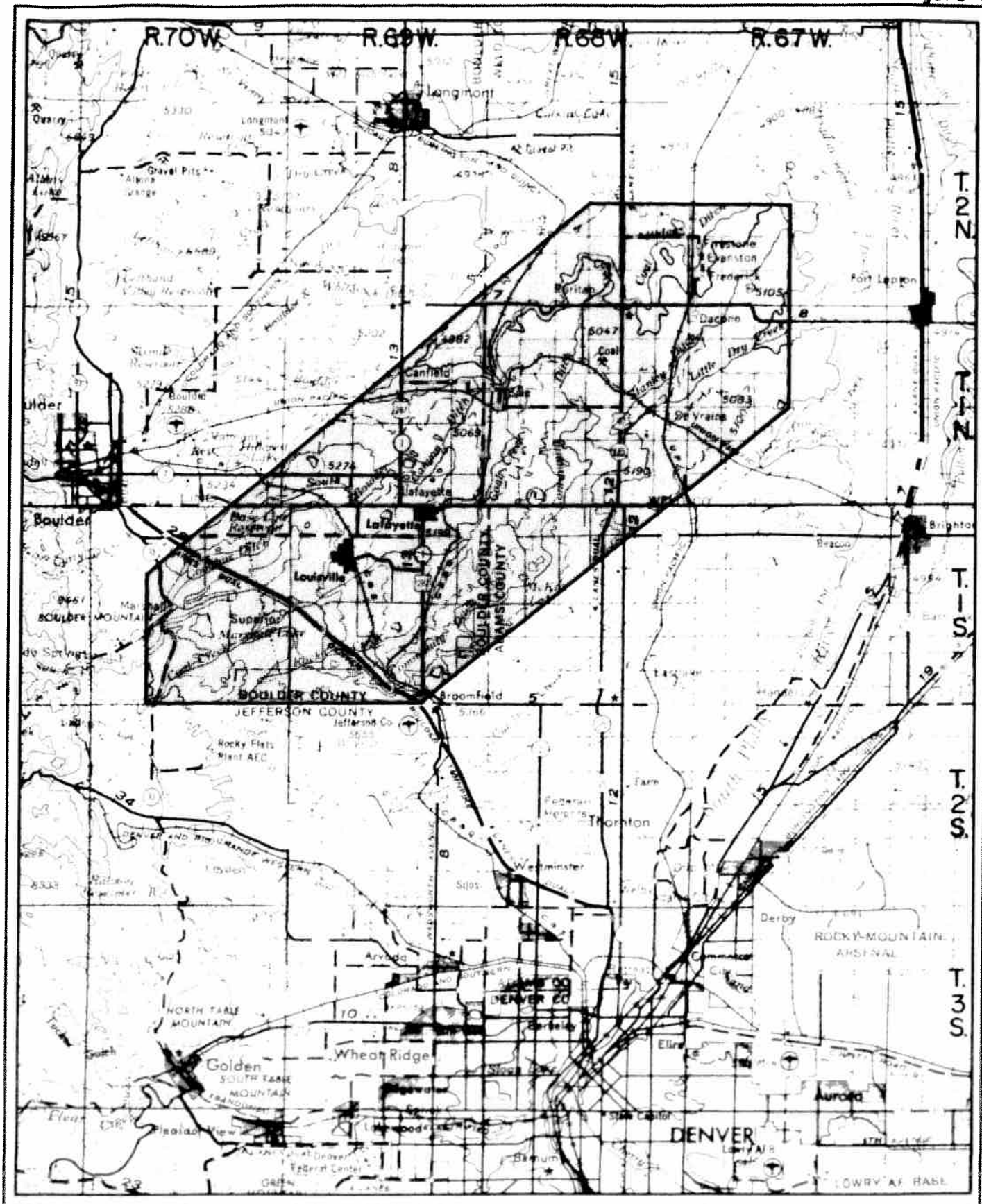

LOCATION MAP
BOULDER-WELD COALFIELD

II. INTRODUCTION AND GENERAL DESCRIPTION OF PROJECT

Purpose and Scope of Study

The purpose of this study is to delineate the extent of mining in the major portion of the Boulder-Weld coalfield as accurately as possible and to define the physical factors controlling subsidence in the area. The scope of the study was confined primarily to a review of existing data and to limited field work. It included the preparation of this report and its accompanying maps, which summarize and illustrate the findings of the study.

This report is intended to provide basic data to local and state planners and to other investigators preparing more detailed studies of specific areas. A comprehensive discussion of mine subsidence and related problems is beyond the scope of this study, which deals with the special problems of a limited area.

Location, Size, and Accessibility of Area

The Boulder-Weld coalfield lies in north-central Colorado about twenty miles north and northwest of Denver as shown in Figure 1. The study area extends northeastward from Marshall (four miles south of Boulder) to just north of Firestone, two miles east of Interstate 25. Approximately 160 square miles were studied. The area includes the southeastern corner of

Boulder County, the southwestern part of Weld County, and the northwestern tip of Adams County.

Accessibility throughout the area is good. Interstate 25 allows ready access to the northeastern half of the area, while the Denver-Boulder Turnpike provides access to the southwestern half. U. S. Highway 287 runs north-south and Colorado Highway 7 runs east-west through the area. In addition to the paved major highways, there is a network of unpaved roads throughout most of the study area. As a result, there are few points which are more than a half mile from either a paved or unpaved road.

Maps and Photos

The study area is completely covered by U. S. Geological Survey topographic maps (Figure 2) at the scale 1"=2000' (1:24000) and a contour interval of 10 feet. These maps are recent and vary in date of publication from 1949 to 1967. They were subsequently photo-revised in 1969 and 1971, and it is the revised editions which were used to construct the base maps for this report.

Aerial photography of the area, taken in 1969 at the scale 1"=1667' (1:20000), was obtained from the Agricultural Stabilization and Conservation Service (U. S. Department of Agriculture). During the course of this investigation, specialized low-sun-angle aerial photography was made by the U. S. Geological Survey. These photos were taken in the summer of 1974 and covered a few limited

Figure 2

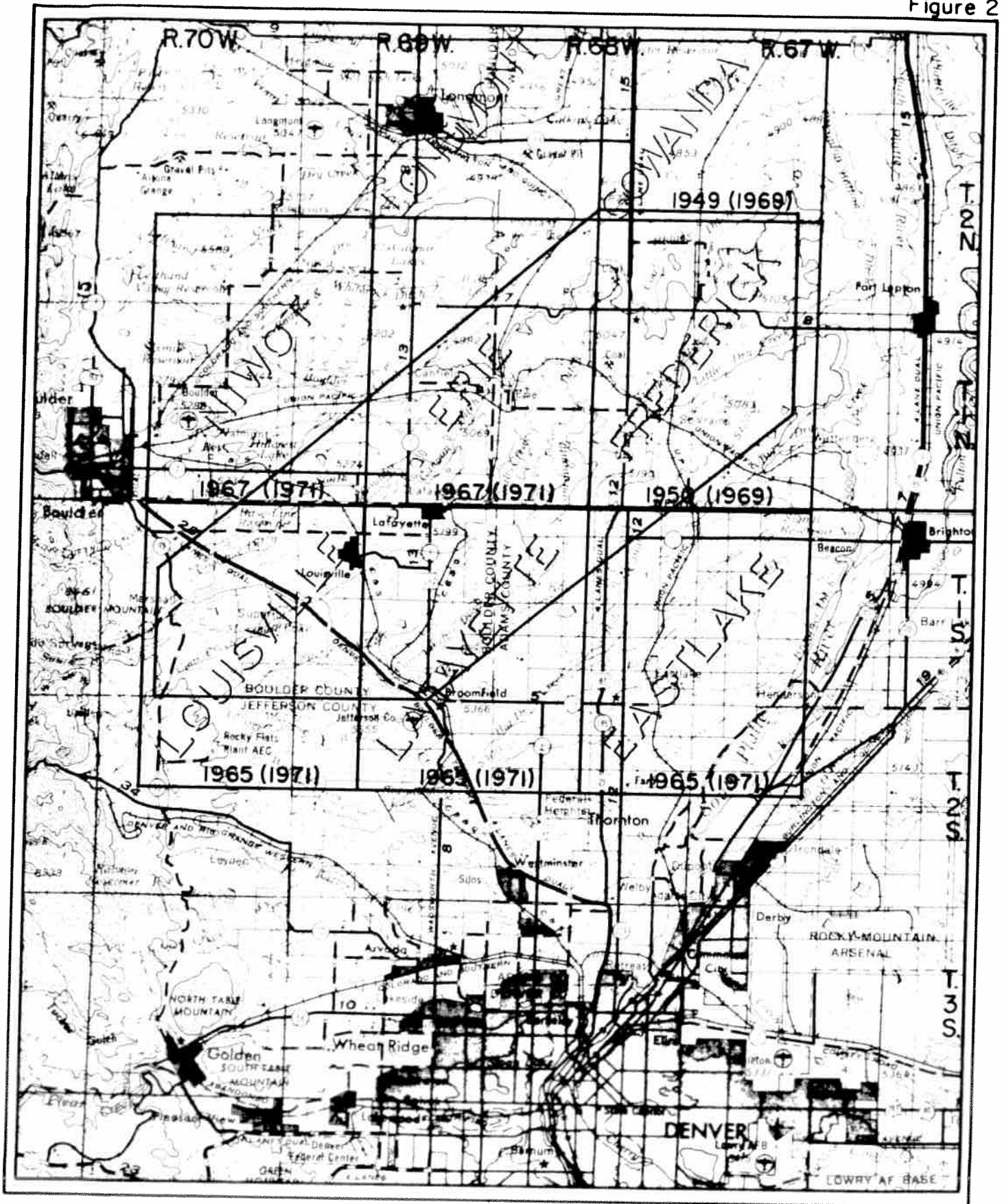

INDEX MAP OF U.S. GEOLOGICAL SURVEY
7 1/2' QUADRANGLE MAPS

Map published 1965

Map photorevised (1971)

areas where there appeared to be subtle subsidence depressions. It was believed that the long shadows cast while the sun was low in the sky would enhance the recognition of the depressions. The Geological Survey consented to our review of this photography and furnished copies of it.

Previous Studies

Three previous major studies of the coal mining industry in the Boulder-Weld coalfield have been made. The Colorado School of Mines Foundation (Grosvenor, 1964) compiled and published a study which showed the location and extent of mining in the area. In addition, the U. S. Bureau of Mines (Lowrie, 1966) published a study of the coal mining industry in the Boulder-Weld coalfield which included a map showing previous mining in the area. This map was updated and revised (Colton and Lowrie, 1973), and published by the U. S. Geological Survey as a map showing mined areas of the Boulder-Weld coalfield.

Acknowledgments

Grateful acknowledgment is made to the Colorado Division of Mines which made coal mine data and individual mine maps available for use in compiling the maps included in this report. Thanks are also given to Roger B. Colton of the U. S. Geological Survey for providing mine maps and information concerning the coalfield and its geology. The U. S. Bureau of Mines kindly

prepared microfilms of unclassified mine maps for our use. Personnel of C. S. Robinson & Associates provided helpful comments on general subsidence problems in the area and allowed us to review certain maps and core-hole information which they had prepared for some of their projects in the area. Mr. D. L. Scroggs, formerly with Amuedo and Ivey, was of great assistance during the initial stages of this project. Finally, special thanks are extended to the various city and county officials, residents, and coal miners of the area (see Appendix A) who gave their time and supplied useful information for this study.

III. GENERAL GEOLOGY

Stratigraphy

Two bedrock units, which dip generally eastward into the Denver basin, occur within the area. The Fox Hills Sandstone and the Laramie Formation are both of Late Cretaceous age. The Fox Hills crops out extensively in the vicinity of Marshall but in other areas is covered by younger deposits. It is conformably overlain by the Laramie Formation, which contains the coalbeds mined in the Boulder-Weld coalfield. Outcrops of the Laramie are rare in the area because of extensive Quaternary deposits of colluvium, pediment gravels, and wind-blown material. The colluvium is ubiquitous; the pediment gravels are most widespread in the Marshall area; and the wind-blown deposits are common in the Frederick-Firestone area. The general character of the bedrock and unconsolidated units in this area is summarized in Figure 3.

Fox Hills Sandstone - This formation is a massive, crossbedded, and ripple-marked sandstone, which is in conformable contact with the top of the underlying Pierre Shale. The lower two-thirds of the Fox Hills is fine- to coarse-grained and slightly calcareous, while the upper one-third is fine- to medium-grained and crossbedded. The thickness of the Fox Hills ranges from 60 feet to over 300 feet and appears to have been controlled by fault movements contemporaneous with deposition.

Figure 3

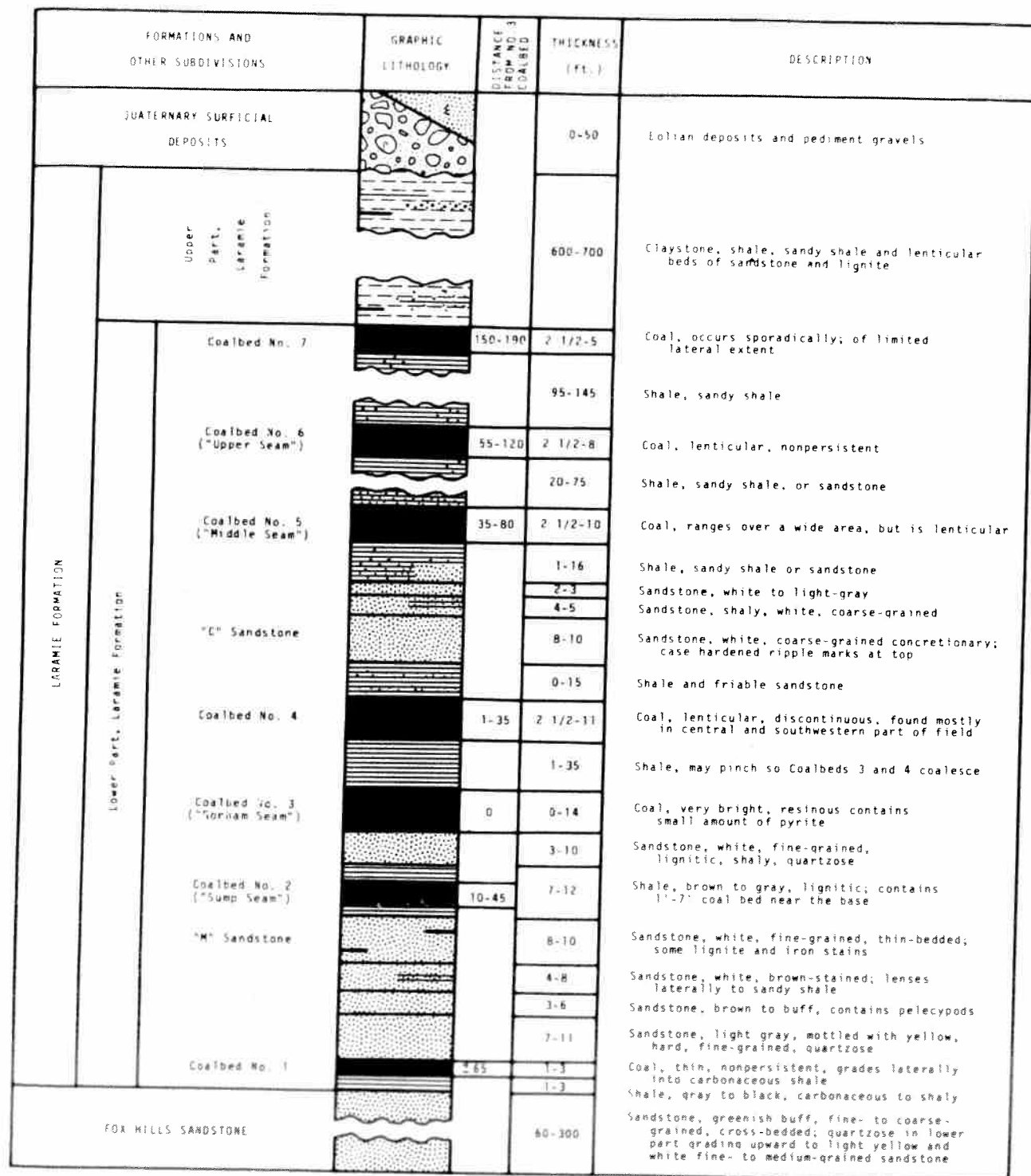

GENERALIZED COLUMNAR SECTION
BOULDER-WELD COALFIELD

Laramie Formation - This unit conformably overlies the Fox Hills Sandstone and is divisible into two parts. The lower part, which varies in thickness from 80 to 125 feet, is composed of sandstone, claystone, clay, shale, and coal. The upper part, about 600 to 700 feet thick, is made up of claystone and sandy shale with some lenticular beds of sandstone and coal. The total thickness of the formation ranges from 600 to more than 800 feet.

Seven coalbeds of minable thickness occur in the Laramie, and they are numbered, from oldest to youngest, in ascending order. Coalbed No. 3, known as the "Main" or "Gorham Seam," has been the most extensively mined, and is the most widespread coalbed in the field. In certain localities, such as the Imperial mine, the bed attains a maximum thickness of 14 feet. Because Coalbed No. 3 is the most widely distributed unit in the coalfield, it is used as a stratigraphic datum to which coalbeds above and below are referred.

1. Coalbed No. 1 and No. 2 are thin and lenticular, and have no known mine workings within them. Coalbed No. 1 lies at the base of the Laramie and is about 65 feet below the No. 3 bed. Coalbed No. 2, also called the "Sump Seam," lies 10 to 45 feet below the No. 3 coalbed.
2. Coalbed No. 4 is 1 to 35 feet above the No. 3 bed. In the Marshall and Lafayette districts, Coalbeds

No. 3 and No. 4 coalesce to form one bed as much as 12 feet in thickness. This combined bed has been mined extensively in these two districts and in the Columbine mine.

3. Coalbed No. 5, locally called the "Middle Seam," is 35 to 80 feet above Coalbed No. 3. It has been mined in the area west of Firestone and east of Dacono.
4. Coalbed No. 6 is known as the "Upper Seam" and is 55 to 120 feet above the Coalbed No. 3. The bed has been mined east and northeast of Erie by both underground and strip mining methods.
5. Coalbed No. 7, the uppermost coalbed, occurs 150 to 190 feet above Coalbed No. 3. Because the bed is thin and very local in occurrence, it has not been mined commercially.

The complex geological conditions of the area, namely, uneven erosion and deposition along with intense faulting and related folding, makes correlation of the coalbeds difficult and in some places doubtful.

In a recent study, Weimer (1973) has suggested that the sandstones of the Fox Hills are a delta front deposit and that

the sandstones, claystones, shales, and coalbeds of the Laramie Formation are a delta plain deposit. Unequal rates of deposition caused by shifting channels within this deltaic environment produced lenticular coalbeds and lithologic units of highly variable thickness and composition.

Fault movement contemporaneous with the deltaic sedimentation also affected the depositional patterns of the two formations. This "growth faulting" allowed increased deposition in the graben areas as these fault blocks moved downward, while deposition over the horst areas was reduced. As a result, vegetal matter, which later formed coal, accumulated in greater thicknesses in the grabens than over the horsts.

Quaternary Deposits - During Quaternary time, streams descending from the Front Range deposited a series of pediment gravels along the mountain front. The Rocky Flats, Slocum, and Verdos pediment gravels cover the Fox Hills Sandstone and Laramie Formation south and east of Marshall.

Recent aeolian sand dunes exist in the vicinity of Frederick and Firestone. The sand is derived from the floodplain of Boulder Creek, which lies to the northwest. The depressions associated with sand dunes and those created by wind scour (deflation) are easily confused with depressions caused by surface subsidence.

Colluvium and soil derived by Recent weathering of the nonresistant Fox Hills and Laramie Formations are widespread throughout the project area.

Structure

The study area is located on the western flank of the Denver basin. Regional dip on this flank of the basin is gently east-southeastward through most of the area, and regional strike is approximately north-northeast. The north-south trending axis of the basin passes through the Frederick-Firestone area.

The study area is complexly faulted into a series of narrow horsts (upthrown blocks) and grabens (downthrown blocks). These fault blocks average about five miles in length and are from 0.5 to one mile in width. The trend of these structures is generally about $N10^{\circ}-20^{\circ}E$, and this is superimposed on a regional fault trend of $N45^{\circ}E$. Beds in the grabens and horsts are folded into synclines and anticlines, respectively. Offset on individual faults may be as much as 500 feet, but the average offset is only about 200 feet (Spencer, 1961). Movement along the majority of the faults was dip slip. Faults with large displacements are natural barriers to mining and therefore define the limits of many mine workings throughout the Boulder-Weld coalfield.

The faults are not obvious on the surface. Their recognition is based, for the most part, on subsurface data obtained during coal mine mapping and from core holes drilled during coal exploration programs (Spencer, 1961, Lowrie, 1966). During the present work, it was not possible to verify, either on the ground or on the aerial photos, the accuracy of the fault mapping done by previous workers. The faulting shown on the map by Colton and

Lowrie (1973) was adopted for this study with only minor changes. A few small faults shown on maps of the Baum and Boulder Valley No. 3 mines were added to the base map prepared for this report.

It is believed that there are probably more faults within the study area than have been shown on the present and previous maps. Many of the faults shown on these maps are known only from underground mine workings. It would be expected that an equal number of faults would occur outside the areas of mining but, owing to surface cover and lack of subsurface information, these faults have remained unrecognized.

Physical Characteristics of the Geologic Section

In the Boulder-Weld coalfield all of the mined coalbeds are within the Laramie Formation. This formation is composed of interbedded shales, claystones, sandy shales, coalbeds, and thin beds of sandstone. Generally, such rock strata are incompetent with respect to stresses induced by underground mine operations. If left unsupported they are subject to fairly rapid collapse after mining.

Local coal miners who have worked in the Columbine, Washington, Eagle, Imperial, and Hiway mines report that while the roofstone of these mines is prone to collapse, an "ironstone" layer occurring 12 to 80 feet above the mine workings tends to stop further upward caving. This ironstone is one- to five-feet thick and may be the quartzose, concretionary "C" sandstone

described by Spencer (1961). In the past, the ironstone created problems wherever it occurred immediately above the mine workings because of a tendency to bend rather than break. The bending created a "squeeze" on nearby pillars of coal and made it impossible to mine them safely. The floors of the previously mentioned mines were soft shale or clay, and a "squeeze" on the pillars was sometimes relieved by a "heave" or rise of the adjacent mine floor.

It is possible that the resistant ironstone layer has prevented caving from reaching the surface in areas of the Columbine, Washington, Eagle, Imperial, and Hiway mines. If so, voids or uncompacted rubble may remain beneath these areas. Similar conditions may exist over other mines of the area as well.

The material that forms the floor of a mine also plays a part in subsidence. A hard sandstone floor might support a standing pillar of coal, while a floor of soft shale or clay (underclay) would allow the pillar to sink. The sinking would continue through the thickness of the soft material and would cause subsidence of the overlying strata. Soft shale and clay floors are reported in the Baseline, Columbine, Eagle, Eldorado, Hiway, Imperial, Industrial, Monarch No. 2, New Gorham, Paramount, Pluto, Standard, Vulcan, Washington, and Witherbee mines. Hard sandstone, shale, or "slate" floors exist in the Black

Diamond No. 2, Boulder Valley No. 1, Evans, Puritan, Shamrock, and Star Mines (Lowrie, 1966). It should be anticipated that mines with hard floors and standing pillars may have a greater percentage of remaining void space than those with soft floors.

IV. REVIEW OF COAL MINE SUBSIDENCE THEORY AND APPLICATION TO BOULDER-WELD COALFIELD

Basic Framework of Subsidence Problem

The basic questions asked with regard to subsidence are few in number and seem deceptively simple to answer. Given an underground opening of known vertical and horizontal dimensions, one wants to know:

1. How much vertical subsidence will there be at the surface?
2. What will be the lateral extent of surface subsidence?
3. When has (or will) subsidence occur?
4. Has the process of subsidence been continuous from beginning to end or has it been episodic?

Generally, the subsidence theories used to answer these questions are based on the assumption that extraction of coal has been complete and that a continuous unsupported void has been created. These conditions do result where longwall mining methods are utilized, as in Europe. However, in the Boulder-Weld coalfield, mining was done by the room-and-pillar method, and the underground conditions created cannot easily be made to fit European subsidence models. It is not within the scope of this report to go deeply into the many facets of subsidence theory, but a review of certain aspects is timely and may be beneficial. For more detailed descriptions of subsidence theory the reader is

referred to a recent work by Zwartendyck (1973). This publication gives a thorough summary of the development of subsidence theory and contains an extensive bibliography.

Subsidence Model

Modern attempts to relate surface subsidence to underground mining make use of the concept of the subsidence trough. The concept takes into account one of the most important observed facts regarding subsidence; namely, that the surface area affected is larger than the mined-out area. Because the concept can be diagrammed, it provides an easy way of looking at, and describing, subsidence problems.

Figures 4 and 5 illustrate diagrammatically the development of a typical subsidence trough. The extraction of coal removes support from the overlying strata causing them to sag into the void space created. The sag is propagated upward to the surface, and, it follows, that the maximum surface subsidence can be no greater than the thickness of the coal bed mined. However, the lateral extent of subsidence at the surface is greater than the extent of underground mining. The surface position of the boundary between areas of subsidence and no subsidence is defined by the "angle of draw." This is the angle between a vertical line and a line drawn from the point of zero surface subsidence to the edge of the underground opening. The angle of draw varies

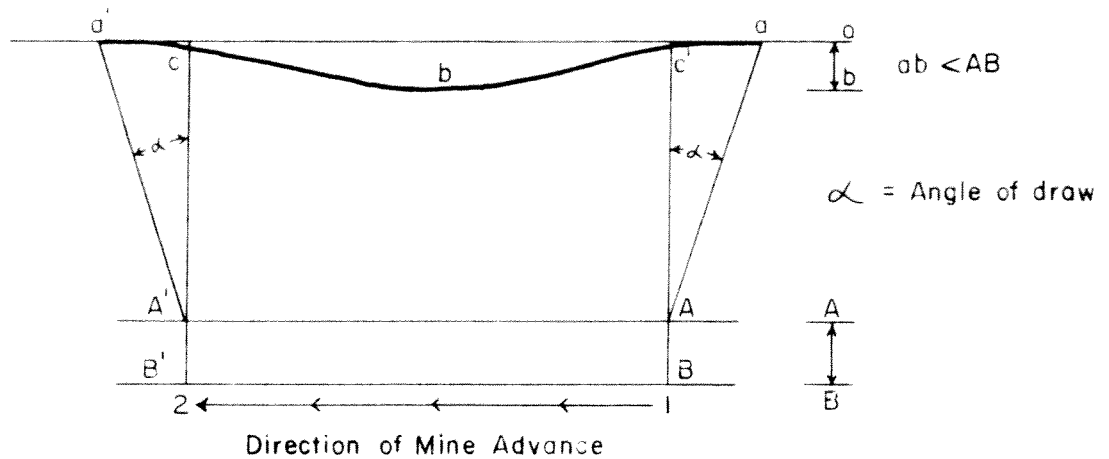

Subsidence Trough before Mining Reaches Critical Width

Figure 4 As a mine face advances from point 1 to point 2 the surface subsidence which occurs will take the form of a shallow trough, shown as curve aba' . The greatest amount of subsidence for a given width of mine opening will be equal to ab and will be located over the center of the opening at b . The amount of surface subsidence will diminish on either side of b until, at points a and a' , it is nil. Since $aa' > AA'$ it can be seen that the area affected by surface subsidence is greater than the mined out opening. Subsidence ab will never be greater than AB and will in fact be less than AB until a certain "critical width" of the mine opening is reached. The line aA connects the point of nil subsidence and the edge of the mine opening and forms one side of the "angle of draw." In British and American literature this angle (α) is measured from a vertical line; in European references it is measured from a horizontal line.

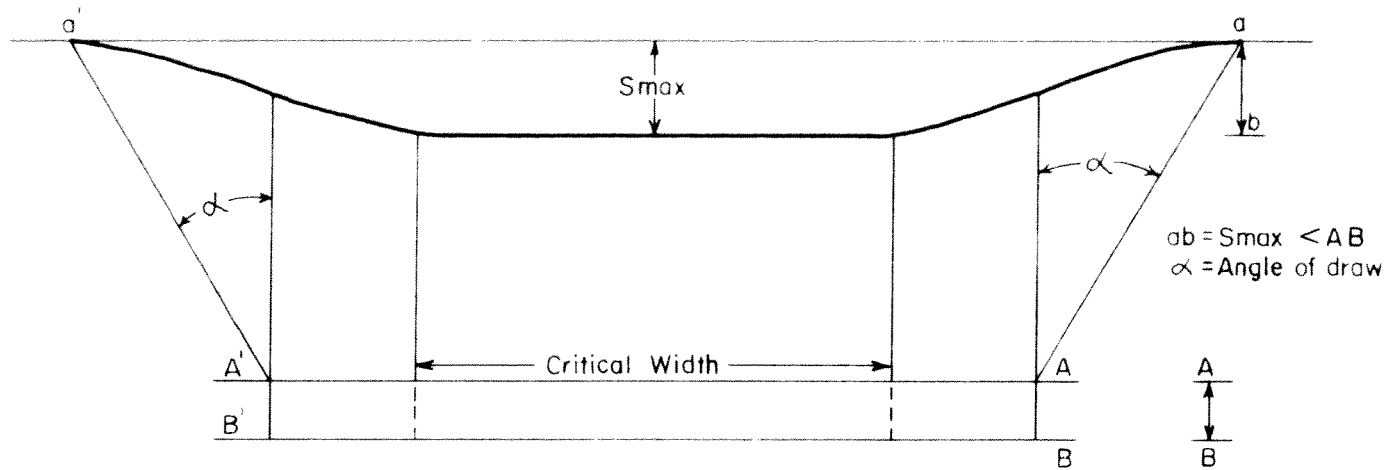

Subsidence Trough after Mining Reaches Critical Width

Figure 5 As the mine face advances, ab and angle α will increase until a "critical width" of the mine opening is reached. At this point the amount of vertical subsidence, ab , reaches a maximum value, S_{max} . Further enlargement of the mine opening will subject a larger and larger area at the surface to maximum subsidence though S_{max} itself will not increase. In three dimensions the deepest part of the subsidence trough will change from an axial line, as would be the case in Figure 4, to a flat bottom as shown above.

from 25° to 35° in most instances. The larger the angle of draw, the wider will be the zone on the surface in which subsidence should occur. By using the largest of several possible angles of draw a greater margin of safety is established for those areas lying outside the boundary of possible subsidence.

Subsidence usually occurs gradually when it is concurrent with mining. After cessation of mining, subsidence may continue to occur in a steady, gradual manner, or it may stop for a period, to be followed by failure at some later date. In some European mining districts, sufficient information has been collected so that the rate, amount, and direction of subsidence can be effectively controlled. In order to accomplish this, much basic information had to be gathered, and special mining programs had to be designed. Subsidence problems are much more difficult to solve in areas where mining has occurred in the past, and where records do not include the data needed to devise means of controlling subsidence. This is true of areas which have been mined in the past in the Boulder-Weld coalfield, but it need not be true of areas mined in the future.

Subsidence in the Boulder-Weld Coalfield

In the Boulder-Weld coalfield, the usefulness of the subsidence trough concept is limited. The model on which the concept is based is an underground opening which is unsupported and free

to collapse as the mine face is advanced. This is the common condition in Europe where the longwall method of mining is used; in the Boulder-Weld coalfield the room-and-pillar method was used almost exclusively. Even though it was common practice to remove the coal pillars after the rooms of a mining panel were fully developed, it was not possible to recover all the pillars. Some were left to protect main shafts and haulageways; others were left because they could not be mined safely. The pillars which remain in the mines continue to support the roofs of underground openings and prevent subsidence troughs from developing in an orderly and predictable pattern. Depending on the number, dimensions, and distribution of pillars which remain in a mine, the width of mine opening could be kept below the critical width for that mine, and subsidence would be prevented from reaching its potential maximum. Surface subsidence would remain below this maximum until the pillars finally gave way sometime in the future.

V. BASIC DATA MAPS - CONSTRUCTION AND ANALYSIS

Extent-of-Mining Map

This map delineates areas of coal mining in the Boulder-Weld coalfield and thus, partly defines the limits of mine subsidence hazard. Previous work on the extent of mining in the coalfield was conducted by the Union Pacific Railroad Company (1964), Grosvenor (1969), Lowrie (1966), and Colton and Lowrie (1973). The extent-of-mining map refines the boundaries of the coal mines as shown on earlier, published maps, and shows the differences which exist between this study and the work of Colton and Lowrie.

This map was compiled by visually reducing the outlines of individual large scale 1"=200' (1:2400) mine maps to a scale of 1"=2000' (1:24000). Most of these maps are on file with the Colorado Division of Mines, some are in the microfilm collection of the U. S. Bureau of Mines, and a few are in the collection of Roger B. Colton, U. S. Geological Survey. In some areas, air photos and field observations of subsidence were valuable in re-defining the extent of underground workings and in determining the existence of several mines which had not been plotted by previous workers. Such areas included the Marshall #1, Marshall #3, Fox, Black Diamond, Old Black Diamond, and Allen Bond mines, mined areas around the Blue Ribbon adit, and an unknown mine in SE 1/4, NE 1/4, sec. 18, T.1N., R.68W. (Figures 6, 13 and 14).

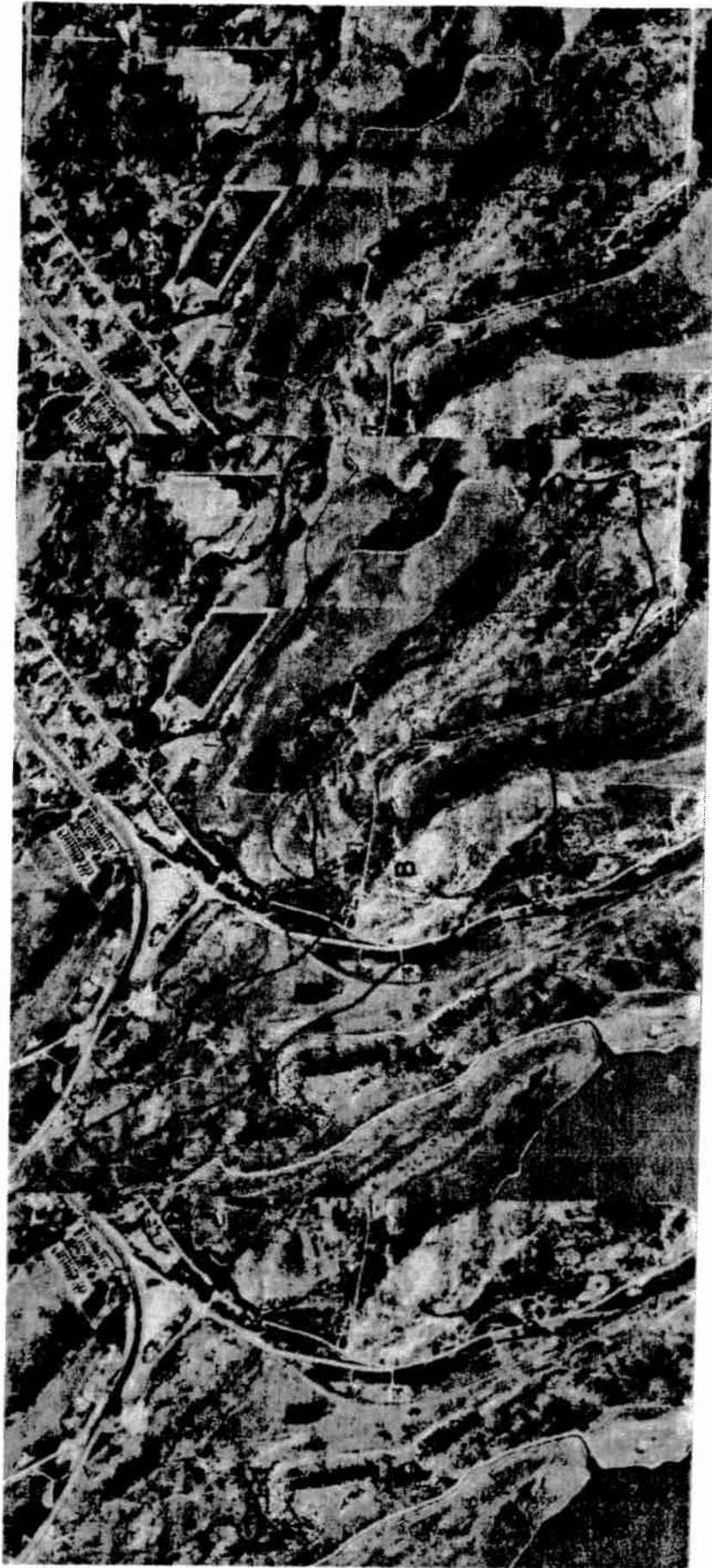

Figure 6. Stereo triplet of Marshall area. Much of the mining in the Marshall area was done before adequate maps and records were kept. Fortunately, mining in this area was very shallow, so that the outlines of the mines are delineated in surface subsidence features. In the absence of good mine maps, these features, as observed in the field and on the aerial photos, were used to determine the extent of mining. The northwest portion of the mining area, as defined by this study (dashed line), differs considerably from the previously reported boundary (solid line). Areas A and B are the same as Figures 29-30 and 31-32 respectively. Photo scale 1"=1667' (1:20000). Localities 1-11, subsidence-inventory map.

The reliability of the extent-of-mining map is dependent upon several factors. First, it is limited by the accuracy of the original mine surveys. Post-1920 mine maps appear to be more carefully surveyed than earlier ones, which may be mere sketches of the mine layouts. The earlier maps may also lack accurate reference to the land surveys shown on surface maps. Second, many of the smaller mines and some of the earlier mines have been recorded with the Colorado Division of Mines, but no maps exist for them. Third, areas of "chiseling" or "poaching" of coal are not shown on the mine maps. The coal removed in this unauthorized manner was usually taken from the barrier pillars between mines. Although the problem has diminished in recent years, miners can point to areas where coal has been poached as much as 200 feet beyond mine boundaries. Some miners feel that wherever royalties are being paid on coal extracted, poaching is common, and thus one might suspect inaccuracies in even the more recent mine maps. Lastly, it is evident from an examination of the only available maps of some mines (eg. Red Ash-Pittsburg, Marshall No. 1) that the maps do not show the maximum extent of mining. In the case of the Fox mine, surface collapse features show that the actual limits of mining extend beyond the boundaries shown on the mine map. Given the above factors, it is estimated that mine limits are within 500 feet of where they are plotted in at least 90% of the instances.

Discrepancies which exist between this study, the Colton and Lowrie study (1973), and the Lowrie study (1966) are generally differences in the limits of the mine boundaries and may be accounted for by differences in plotting techniques, or by the utilization of different mine maps. Some of the more important areas of discrepancy are:

1. A small mine north of the Fireside (NE 1/4, sec. 7, T.1S., R.69W.)
2. The area west of the Acme mine (SW 1/4, sec. 8, T.1S., R.69W.)
3. The area northeast of the Vulcan mine (NE 1/4, sec. 10, NW 1/4, sec. 11, T.1S., R.69W.)
4. The area east of the Imperial and Eagle mines (SW 1/4, sec. 11, NW 1/4, sec. 14, T.1N., R.68W.)
5. The southeast side of the Puritan mine (SW 1/4, sec. 2, T.1N., R.68W.)
6. A lobe of the Lincoln mine (SE 1/4, sec. 24, T.1S., R.68W.)
7. A mine south of the Witherbee-Peerless complex (SW 1/4, sec. 4, T.1N., R.67W.).

This study, utilizing the available mine maps, and to some extent, interviews with residents and miners, could not confirm the existence of mine workings in these areas.

Depth-of-Cover Map

The purpose of the depth-of-cover map is to show the thickness of overburden above mine workings. To simplify the overburden thickness determinations, a 50 foot contour interval was used.

In obtaining the depth-of-cover values, it was necessary to determine the elevations of the mine workings. When available, this data could be taken from individual mine maps, from records of shaft depths as reported to the Colorado Division of Mines, and from drill-hole information of the Rocky Mountain Fuel Co. With this information, a structure contour map of the top of the extracted coalbed was made for each mined area. A surface topographic map was superimposed on this map, and structure contour values were subtracted from surface contour values. The resulting overburden thickness values were plotted to the extent-of-mining base map and were contoured using the 50 foot interval. For mined areas with multiple seams, the overburden above the highest mining level was contoured.

The main problem involved in determining the overburden thickness is the lack of elevation data on many mine maps, especially pre-1920 mine maps. In such cases, drill-hole data and shaft-depth records were utilized as an approximation of the depth to mine workings. If these data were lacking, an estimation of overburden thickness was made by 1) extrapolating structure contours from adjoining mine workings where the same coalbed was being mined, 2) interviewing residents who had drilled water wells into the mine workings, 3) interviewing miners who had worked in the mines, and 4) relating the character of subsidence in the unknown areas to the character of

subsidence in other areas where the overburden thicknesses were known. In all cases in which only one data point was available, the coalbed was assumed to be horizontal, and overburden thickness was determined accordingly. The data available and the method used in obtaining overburden thickness determinations for different mined areas are shown on the map.

The sources from which mine data were obtained generally gave elevations to the nearest foot and in some cases to the nearest 0.1 foot. Considering the 50-foot contour interval used, the depth-of-cover map is believed to be fairly reliable. Because of the scarcity of mine elevation data, all available information sources sometimes had to be utilized to make a reasonable estimation of depth of cover. Where information was sufficient and where different methods of determining overburden were available, an effort was made to cross-check the overburden determination by testing one method against another. For example, elevations taken from mine maps were checked against data from nearby drill holes.

Incongruities between overburden determinations of different mined areas on this map are attributable to four variables. First, topography above different mined areas varies over the coalfield. Because overburden thickness in areas of nearly horizontal beds is largely a function of topography, it can be expected that the depth of cover will vary with the topography

throughout the area. Second, there is a considerable variation in the stratigraphic interval between the various coal seams throughout the coalfield. Third, faults disrupt the continuity of strata in the coalfield, and the resulting offset of coal seams has produced differences in overburden thickness in adjacent mined areas. Finally, there is a slight amount of dip to the south and east throughout the study area. Coalbeds become progressively deeper, and overburden increases in thickness, in these directions.

Mine-Pillars Map

The purpose of the mine-pillars map is to delineate within each mine, and mine level, the areas where pillars of coal have been removed ("pulled" or "mined-out") and the areas where pillars were left standing. It is important to realize that pillars which are shown in place on the most recent mine maps may have deteriorated, and possibly collapsed, since the maps were made.

The reliability of the map showing areas where pillars have been pulled is commensurate with the accuracy and completeness of the original mine maps.

Individual coal mine maps with a scale of 1"=200' (1:2400) were reviewed to determine the areas of pillar extraction and the areas of remaining pillars. The areas of pillar extraction and pillar non-extraction shown on the individual mine maps were visually reduced to a scale of 1"=2000' (1:24000) and were compiled to a copy of the extent-of-mining map.

It became apparent during the compilation of the mine-pillars map that many of the individual mine maps were of dubious accuracy and are considered unreliable as far as delineating areas where pillars were pulled. Often, the individual mine maps merely indicated that large areas are "worked-out," but did not show the outlines of pillars which were left standing and pillars which were pulled. On such maps, it is impossible to tell how many pillars, if any, remain in these "worked-out" areas.

In fact, miners report that an average of 30% of the originally available coal must be left in a mine, even under the best of conditions. Usually, the percentage of coal remaining is much higher, and commonly 40% to 50% of the coal originally in place is left behind. This residual coal is left in the backs of mines as a means of roof support, in mine floors, and in pillars. Some pillars are purposely left to protect main haulageways and shaft areas; others are left in order to maintain a margin of safety while nearby areas are worked. If it is assumed that 30% of the coal originally in place was left behind when a given area was "mined-out," it is probable that some pillars still exist in that area even though active mining ceased years ago.

The presence or absence of standing pillars underground is critical to the question of mine subsidence potential. If nearly all pillar support has been removed beneath an area, it is

likely that subsidence over that area occurred shortly after the cessation of mining and is now essentially complete. However, in those areas where pillars are still standing it is likely that subsidence is not complete. Eventually the pillars in these latter areas will collapse due to the separate or combined effects of air slaking, ground water, stress build-up from other parts of the mine, and increased surface loading from newly constructed buildings. Therefore, areas shown on the mine-pillars map as having remaining pillars should be regarded as potentially more hazardous than those areas which are shown as having most of the pillars removed.

Probable-Thickness-of-Extracted-Coal Map

The purpose of the probable-thickness-of-extracted-coal map is to determine the maximum possible height of the void space which could exist as a result of mining activities. The height of the void space is assumed to be equal to the thickness of the coal extracted in a given area. This thickness would then be equivalent to the maximum amount of surface subsidence which could occur over that area.

It should be mentioned that, in many cases, mining practice was to leave a certain thickness of coal in the mine roof to provide support for the mine opening. Where this practice was followed, the full height of the coal was not removed. Since no records were kept of the amount and distribution of roof coal

In spite of the above problems, the map is considered reliable within certain probable minimum and maximum void-space heights. The heights of mine openings were seldom less than five feet because of economics and the limitations of machine mining (after 1946). Since there are few areas where coalbeds attain a thickness of more than 15 feet, it can be assumed that mine openings are usually less than that figure. The map shows that most of the maximum possible subsidence falls within the 5 to 10 foot range, and that the areas of maximum possible subsidence greater than 15 feet occur mainly over those localities where there was multiple-level mining.

Subsidence-Inventory Map

The subsidence-inventory map is the result of a program composed of field observations and interviews with local residents. The purpose of this program was to locate the known subsidence areas in the Boulder-Weld coalfield. Areas of presently (1974) observable subsidence and areas of reported, but no longer observable, subsidence were noted. Also, observations were made in areas where there is some question as to whether the area was even undermined.

A number of criteria were used to determine where subsidence had occurred. In the field, pits and collapse features over areas of known shallow mining were considered positive identification features of subsidence (Figures 7-14). Closed



Figure 7. Collapse over room of Marshall No. 1 mine. The collapse area is approximately 15 feet by 30 feet and is about three feet deep. From five to ten feet of coal were extracted from this area at a depth of about 50 feet. Lower slopes of hill in background are also shown in Figures 6 (Area A), 8, 31, and 32. Locality 4, subsidence-inventory map.



Figure 8. Collapse area over Lewis No. 1 and No. 2 mines. Rooms of these mines are expressed by depressions and pillars by ridges. Mining was at a depth of less than 100 feet, and five to ten feet of coal was extracted. Compare joints in exposed sandstone in foreground with same area shown on Figures 31 and 32. Locality 7, subsidence-inventory map.



Figure 9. Collapse over room of Lewis No. 1 mine. Pit is about ten feet by 15 feet and is three feet deep. From five to ten feet of coal was extracted at a depth of approximately 50 feet. Flume carrying irrigation water in middle background must be periodically re-set because underground mine fires in this area are causing continued subsidence. Locality 7, subsidence-inventory map.

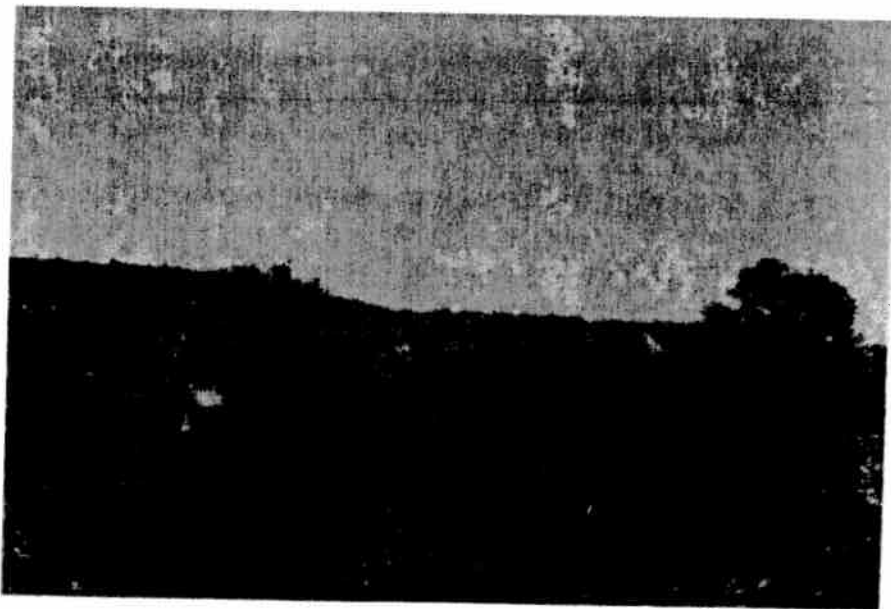

Figure 10. Recent subsidence over Lewis No. 1 and No. 2 mines brought on by underground fire. Note three puffs of grayish-white smoke. Mine is less than 50 feet deep and is above water table. Collapse and fracturing of overlying beds permits circulation of air for continued combustion. Between localities 7 and 8, subsidence-inventory map.



Figure 11. Large subsidence pit over the Premier mine. The pit is approximately 30 feet in diameter and eight feet deep. Five to ten feet of coal was mined at a depth of about 100 feet. Near locality 1, subsidence-inventory map.

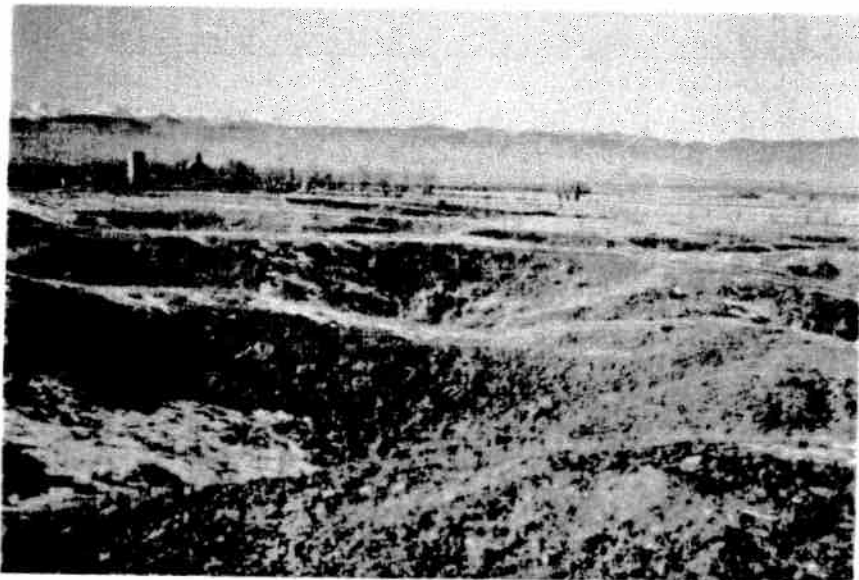

Figure 12. Large, well-developed subsidence pits over rooms of the Shanahan mine. Pits are eight to ten feet deep and are 15 to 25 feet across. The coal seam at this mine was unusually thick (10 to 15 feet), which accounts for the large amount of vertical subsidence. The mining depth was less than 50 feet. Locality 21, subsidence-inventory map.

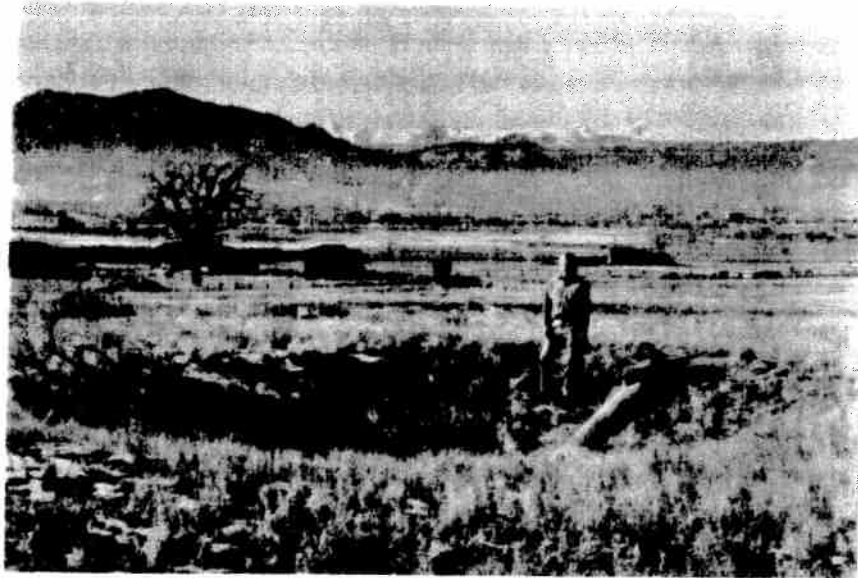

Figure 13. Collapse pit over the Allen Bond mine. Features such as this aided in locating the true position of the Allen Bond mine. The previously reported position of the mine showed no evidence of surface subsidence. A thick (10 to 15 feet) coal seam was mined here at a depth of approximately 50 feet. Locality 19, subsidence-inventory map.

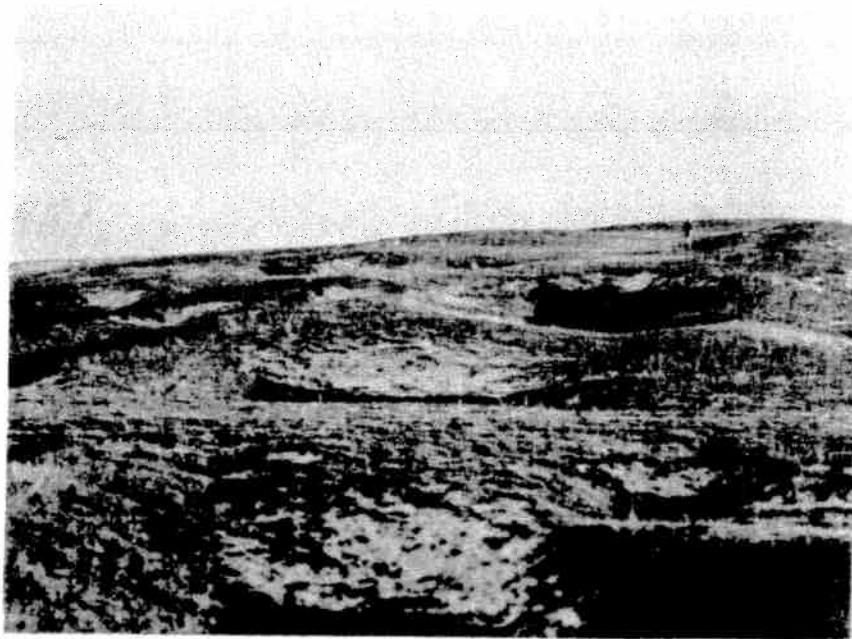

Figure 14. Numerous subsidence pits above an unreported mine just east of Erie. No maps were found of this mine in the files of either the Colorado Division of Mines or the U.S. Bureau of Mines. Examples such as this illustrate the necessity for field reconnaissance of all prospective development areas. Based on conditions in nearby mines, it is estimated that five to ten feet of coal was extracted at depths of 50 to 100 feet. Locality 67, subsidence-inventory map.

depressions (Figure 15), features of less positive subsidence evidence (swales and broad ground "sags," Figures 16-17) and areas of reported but unverified subsidence were also noted. Recent (1969) aerial photographs were of some use in delineating areas of subsidence over areas of shallow mining such as the Fox, Allen Bond, Pluto, Northwestern, and an unknown mine in NE 1/4, sec. 18, T.1N., R.68W. In Weld County, older (1949) aerial photographs were used to determine an area of subsidence over the Shamrock mine (depth of cover about 100 feet). This area was leveled and reclaimed for farming in 1956 and all surface evidence of subsidence was obliterated at that time.

Interviews with local residents were valuable in pinpointing areas where subsidence and related structural damage had occurred in the past. Interviews with miners were especially useful in determining where subsidence had occurred because these men were aware at the time that a given area was being undermined, and were watchful for surface effects. Field observations of structural damage to buildings, streets and sidewalks (Figures 20-24) were also used to determine subsidence occurrence.

Numerous complicating factors were encountered in the identification of subsidence features. In addition to the land-leveling program conducted by the U. S. Department of Agriculture over the Shamrock and other mines, individual farmers sometimes restored land damaged by subsidence. Shafts and pits were filled with debris and were then covered with topsoil. Subsidence evidence also is masked by crops and tillage. This is probably the case



Figure 15. Water-filled depression over Nonpariel mine. Depression is partially closed by base of section line road. This is a typical example of a questionable subsidence feature. Near locality 40, subsidence-inventory map.

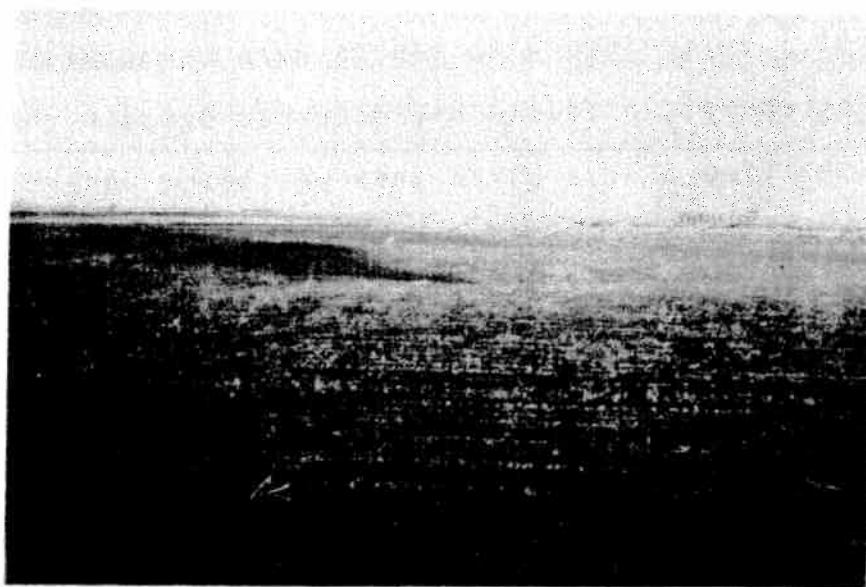

Figure 16. Broad swale over Lincoln mine. The swale in middle foreground is fortuitously outlined by shadows cast by setting sun. Normally, this feature would be hard to discern by the unaided eye since it is quite broad (100 feet) and is only two or three feet deep. The mining depth at this locality is 150 to 200 feet and five to ten feet of coal has been extracted. Tipple of the Lincoln mine is in background. Locality 77, subsidence-inventory map.

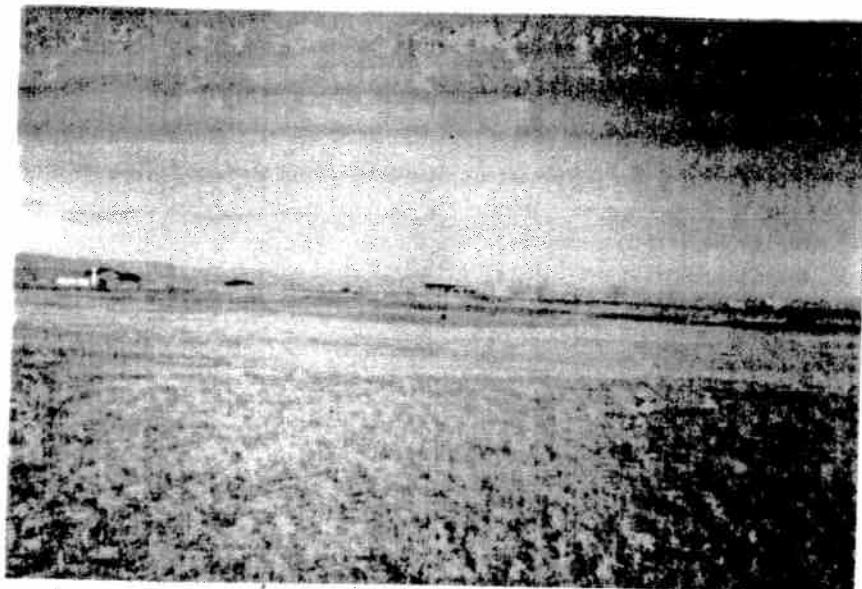

Figure 17. Broad sag over Morrison mine. Depression has a relief of only a few feet and does not really provide definitive evidence of subsidence. Careful survey measurements might show that the depression is closed, and this would strengthen the case for a subsidence origin. Five to ten feet of coal were extracted at depths ranging from 100 to 150 feet. Near locality 69, subsidence-inventory map.

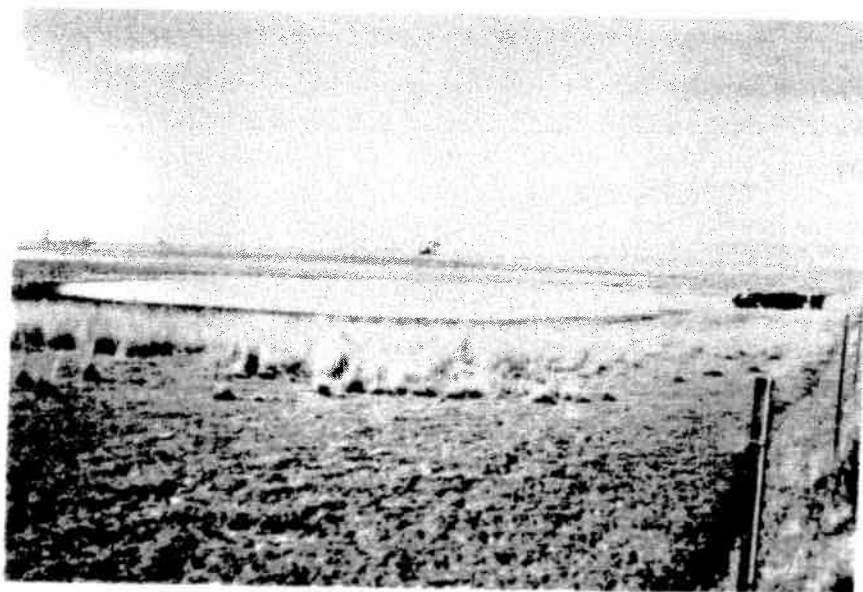

Figure 18. Water-filled depression just east of Russell mine. This depression lies a few hundred feet beyond the reported eastern limit of the Russell mine. This may be a case of subsidence over an area which was poached and the mining was not reported. The shallow (one to two feet) depression may also be the result of wind erosion. Locality 94, subsidence-inventory map.

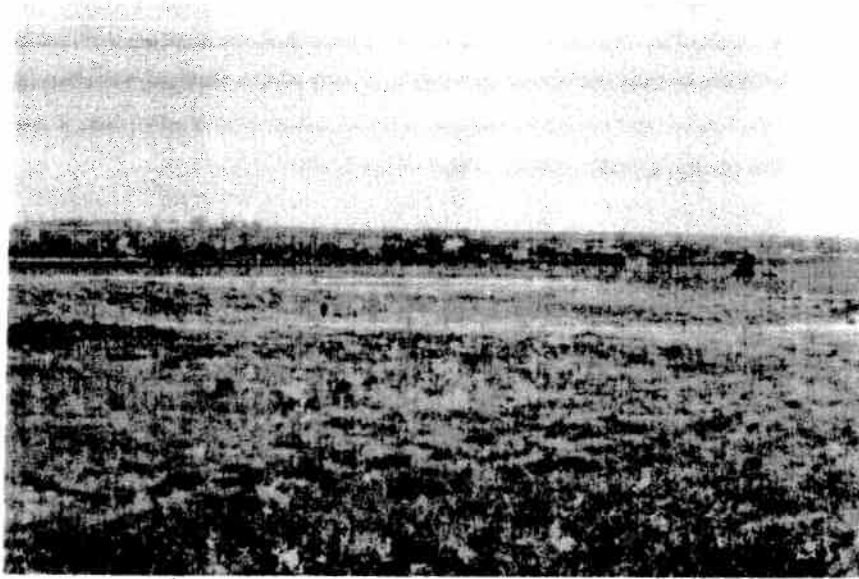

Figure 19. Sand dune area one-half mile west of Firestone. Undulations of fence line indicate the irregular nature of the topography. This area overlies the Frederick mine where a five to ten foot coal seam was mined at a depth of 100 to 150 feet. The poor, sandy soil of the area and the close proximity of an undoubted dune field indicate that the irregular topography is due to wind deposition rather than subsidence.

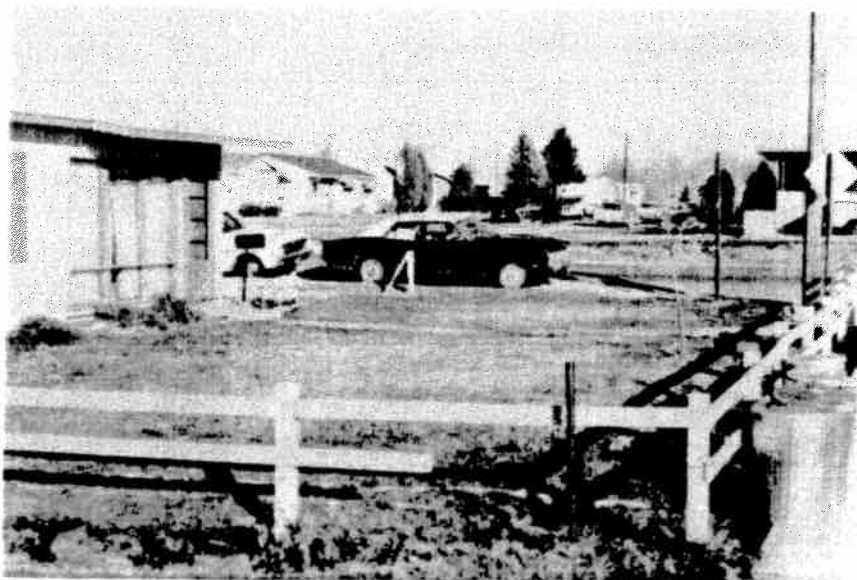

Figure 20. Subsidence over Strathmore mine, South Longmont Street, Lafayette. The low sag in the front lawn and the front walk are subsidence related. This "subsidence" is actually the result of compaction of trash and rubble used to fill a true subsidence pit which formed in 1956 (Denver Post, May 27, 1956). There was rapid collapse and overnight development of a hole 40 feet deep and 15 to 20 feet square. Locality 55, subsidence-inventory map.



Figure 21. Subsidence over Strathmore mine, South Longmont Street, Lafayette. The most recent damage to the street has not yet been fully repaired. Note unpaved section of street and sagging sidewalk. The coal seam in this area of the Strathmore mine was quite thick, and the probable thickness of coal extracted was 20 to 25 feet. Depth of mining was 100 to 125 feet. Locality 55, subsidence-inventory map.

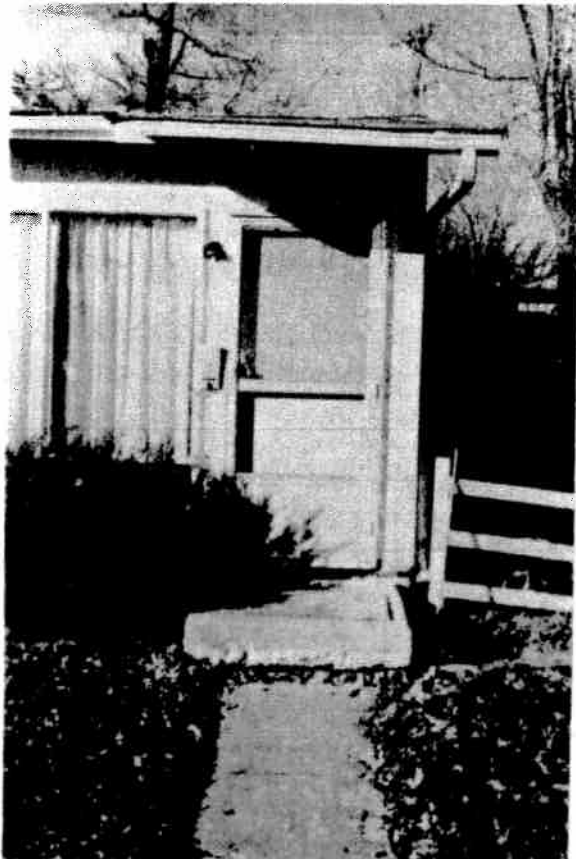

Figure 22. Front stoop of house to the right in Figure 21. This house is immediately south of home shown in Figure 20. The walk has pulled away from the stoop and it in turn has pulled away from the house. Bricks have been jammed beneath the house and beneath the stoop for temporary support. Locality 55, subsidence-inventory map.

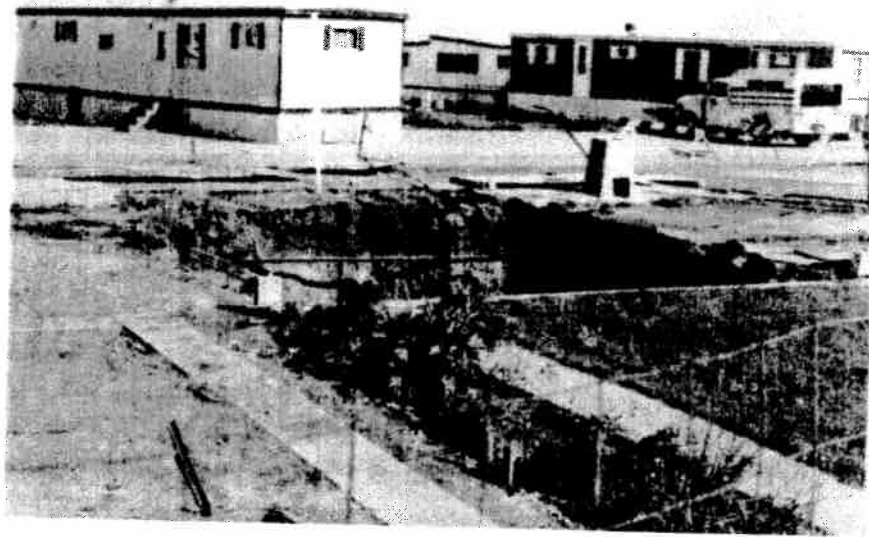

Figure 23. Subsidence pit at a trailer court in Lafayette. Ground began caving in the early morning of August 29, 1974, and continued to enlarge until noon. Final dimensions of the subsidence pit were 24 X 18 X 15 feet. The subsidence occurred in a vacant area and only minor damage to utility lines was sustained. Had one of the large "mobile" homes shown in the background of this figure been parked on top of the subsidence area it is doubtful that it could have been moved quickly enough to save it. This recent event is a dramatic example of continuing subsidence problems in an area where mining ceased over half a century ago.

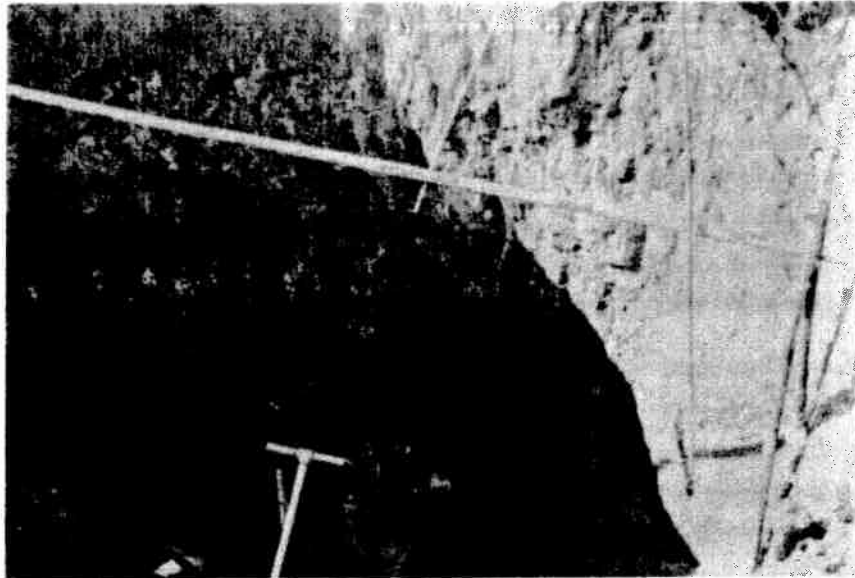

Figure 24. Detail of subsidence pit at trailer court in Lafayette. The upper 12 feet of the subsidence pit walls are composed of sand and silt size material; the lower three feet of the pit consists of bedded, angular gravel. The subsidence occurred over the Strathmore mine which lies at a depth of 100 to 150 feet and was last worked in 1919. Normally only one level was worked in this mine but in the area of the trailer court two levels were mined and it is estimated that a total void space of 20 to 25 feet was created.

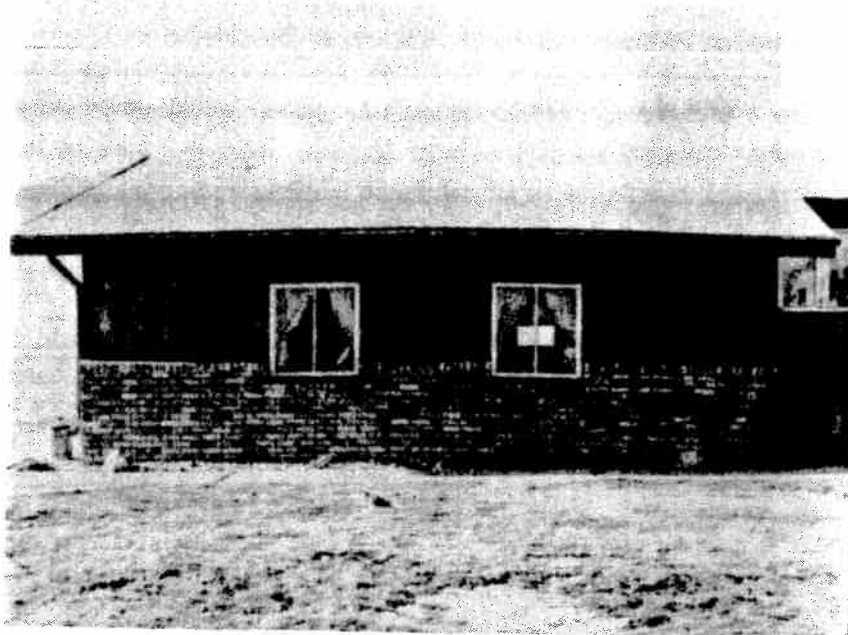

Figure 25. Garage over Black Diamond mine. At this locality, five to ten feet of coal were extracted at a depth of 150 to 200 feet. The garage and house are fairly isolated, so that the surrounding terrain is relatively undisturbed by man. No pits, swales, or other indications of subsidence were found in the fields around the house. For this reason, the damage to the garage is thought to be due to swelling soils. Note bow in roof line along gutter. Locality 15, subsidence-inventory map.

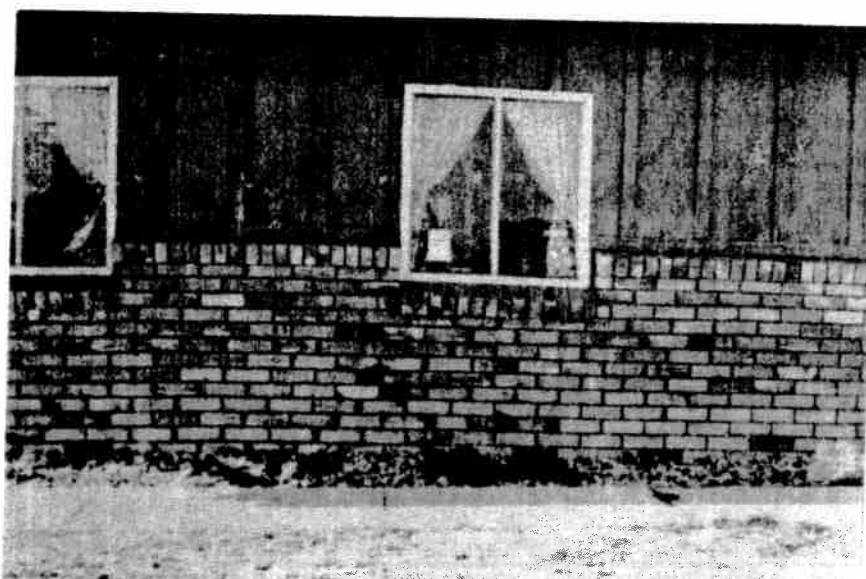

Figure 26. Detail of garage shown in Figure 24. Stairstep cracks in brickwork are one-half inch wide. Window has rhomboid shape, and glass is cracked. This damage is similar to what one might expect if ground beneath foundation had subsided. Locality 15, subsidence-inventory map.



Figure 27. Damage to VFW hall, Main Street, Louisville. This part of Louisville was undermined many years ago. A seam 10 to 15 feet was extracted at a depth of about 100 feet. Because the mining occurred so long ago, it is thought that the damage to this relatively recent building is related to faulty design or construction, rather than to subsidence. Locality 43, subsidence-inventory map.

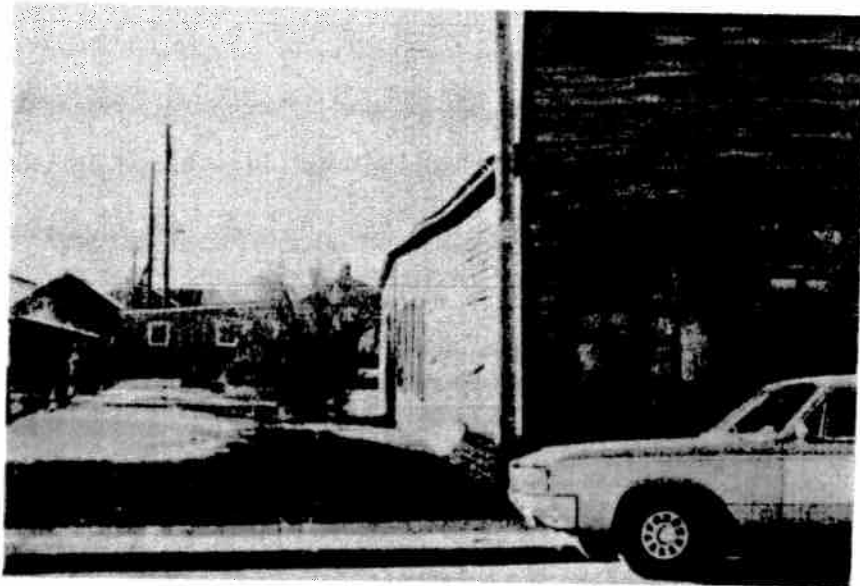

Figure 28. Abandoned building, Main Street, Louisville. The undulatory line of the siding and the rhomboid shape of the windows suggest torsional effects which might be associated with subsidence. However, the obvious age of the building suggests that the structural warping is simply due to general deterioration over a long span of time. Locality 43, subsidence-inventory map.

in a great many areas of the coalfield, notably over the New Crown, Matchless, Helca, Rex #1, Mitchell, Morrison, Frederick, Puritan, Grant, and Witherbee-Peerless mines.

Another complicating factor in subsidence identification is that surface effects above deeper mines (greater than 200 feet) are likely to be faint. Unless observed immediately after mining, they may soon be totally obscured. Subsidence over deeper mines is not represented by well-defined pits and swales, but is typified by broad depressions several hundred yards in diameter. Even broad depressions over known mined areas may be suspect because "blowouts" (wind-eroded depressions) occur in the area, especially around Frederick and Firestone (Figures 18-19).

Damage to structures built over mined areas cannot always be attributed to surface effects of caving in the mines. Other factors which must be considered before ascribing damage to subsidence are 1) instability of the slope on which the structure is built, 2) compaction of fill, 3) swelling clays around foundations (Figures 25-26), 4) thermal effects, 5) faulty design or construction (Figure 27), and 6) gradual structural deterioration with time (Figure 28). Furthermore, minor structural damage to highways, railroads, and irrigation systems, as a result of subsidence, is usually repaired on a routine basis. Lastly, subsidence damage to residences may be repaired or disguised so that property values will not be lowered.

Reports by residents and miners are useful in locating past evidence of subsidence, but are often difficult to verify. In one such instance, a miner pointed out that he had assisted in surveying a grid of points over the Eagle mine SW 1/4, sec. 14, T.1N., R.68W., where the depth to mine workings is approximately 300 feet. A subsidence of 23 inches was measured three to six months after pillar removal. The area is presently being farmed, appears to be a smooth slope, and no distinct subsidence evidence is discernible.

After taking the above complications into consideration, it is estimated that 90% of the subsidence which can be presently observed has been identified. The subsidence inventory has shown that no well-defined, presently observable subsidence occurs in areas where overburden is greater than 150 feet. Subsidence in areas with a greater depth of overburden is difficult to verify by routine field observation.

VI. FIELD WORK

Field work consisted of personal interviews, foot traverses over mined areas, and examination of local historical records. Approximately 15 man-days were spent in interviews with persons having knowledge of past mining and subsidence in the area. Such people included active and retired miners, local librarians, historians, newspaper editors, city and county planners, and landowners with property overlying mines. Initial contacts were made through letters of introduction provided by the Colorado Geological Survey and through advertisements placed in local newspapers. As the interview program progressed, word-of-mouth suggestions led to meetings with additional knowledgeable people. A list of the individuals contacted is included as Appendix A of this report.

Retired miners were most helpful in providing information on mining practices and subsidence over the more recent mines in Weld County. In Boulder County, many local residents gave descriptions of past subsidence events and pointed out present-day subsidence features. All subsidence reports stemming from these interviews were then field checked.

Approximately 25 man-days were spent in field checking the above reports and investigating other areas of possible subsidence. The land above the coal mines was traversed to observe evidence of subsidence and unrecorded mining activities. Every

mined area in the coalfield was walked and (or) driven over, or was, at least, observed from the nearest section line road.

Aerial photographs were carried in the field, and the locations of possible subsidence features were plotted on them. Observations were summarized in field notes written at each location visited. The results of the field survey were utilized in the construction of the subsidence-inventory map. In a few cases, field observations indicated that mine boundaries on the extent-of-mining map had to be enlarged or reduced.

Historical records dealing with coal mining and mine subsidence were examined in the town libraries of Louisville and Lafayette and in the homes of long-time residents of the area. The State Historical Society library, the Denver Public Library, and the Denver Post library provided access to back issues of local and regional newspapers now long defunct. With few exceptions, the newspapers and records examined dealt with mine collapse only as it affected the miners or the mine workings. Instances of surface subsidence during the time of greatest mining activity (1905-1945) usually occurred in sparsely inhabited areas where land values were low and were either not newsworthy events or went unnoticed.

VII. SPECIAL-PURPOSE ACTIVITIES

In addition to the main programs of basic-data map compilation, field work, and interviews, certain other activities relating to mine subsidence detection were carried out. These activities consisted of a photogeologic review of recent (1969) aerial photography, a comparative study of this photography with aerial photos taken 20 years earlier, and a study of special, low-sun-angle, low-altitude aerial photos taken over selected mine areas. Acquisition and study of multi-band photography was initially considered, but it was later decided that the low-sun-angle photography offered a more fruitful line of research.

Photogeologic Review

A photogeologic review of the coalfield was made using Agricultural Stabilization and Conservation Service (A.S.C.S.) photos taken in 1969 at a scale of approximately 1"=1667' (1:20000). Stereoscopic examination of the photos showed that soil and vegetation cover obscured nearly all the bedrock geology. Only two rock units occur within the area, and neither have any distinctive photogeologic characteristics. More disappointing is the fact that few of the many northeastward-trending faults which have been reported in the area can be detected on the photos. It has been equally difficult to find field evidence for these

faults. As noted above, most of the faults are based on sub-surface data, and their lack of recognition in the field and on the photos is probably due to a combination of low dip, soil and vegetative cover, and similarities in lithology between the two surface rock units.

The air photos were useful in making a rapid appraisal of the surface overlying mined areas. The surface could be classified as showing 1) well-defined subsidence features, 2) possible indications of subsidence, and 3) no evidence of subsidence. Well-defined subsidence features usually take the form of small pits 10 to 30 feet across and 3 to 10 feet deep (Figures 7-14). Rarely, there are larger areas of collapse forming depressions 50 to 100 feet across and 5 to 10 feet deep. At a scale of 1"=1667' (1:20000), the pits appear quite small on the photos and single, isolated pits are easily overlooked (Figure 6). Fortunately, they commonly occur in easily recognizable clusters of a half dozen to a hundred or more pits. In untilled pastureland, the pits have remained undisturbed since their formation and are easily recognized on the photos. Where the land has been tilled, the pits have lost their definition, either because the ground has been worked over many times during the normal course of farming, or because an active program of pit-filling and land-leveling has been carried out by the landowner.

Possible subsidence indicators include slight depressions, areas of mottled crop cover, and areas of poor drainage. The

mottled vegetation patterns are produced by areas of darker-toned lush vegetation whose vigor is due to a more abundant supply of water collecting in subsidence-formed depressions (Figure 15). If too much water collects, however, the vegetation is killed and the depression is marked by a small pond or by a mud flat (Figure 18). The latter sometimes have alkali crusts whose white color is distinctive on the photos. Mottled vegetation, shallow depressions, and poor drainage are not definitive subsidence features. All can be produced by natural processes other than subsidence, such as wind (deflation), or by the activities of man, such as the construction of stock ponds and the opening of borrow pits.

The photogeologic review showed that in the coalfield well-defined subsidence features are usually present in those areas where depth of mining is less than 100 feet. Where mining depths are 100 to 200 feet, good subsidence indicators are sparse, and one must work with less definitive features such as swales, shallow depressions, and areas of poor drainage. In those areas where mining has been at depths greater than 200 feet, the surface usually has no subsidence features which can be observed on the photos.

As a rule, the correlation between mining depth and photo recognition of subsidence features was also found to apply to field observations. Even though subsidence has undoubtedly occurred in areas where mines lie more than 200 feet below the surface,

the effects of such subsidence are probably spread over a wide area. It is possible that these subtle subsidence effects might be detected in the field by comparing precise surveying measurements made before and after mining.

Comparison of 1949 and 1969 Aerial Photography - A set of aerial photos taken in 1949 by the U. S. Geological Survey at a scale of 1"=1385' (1:16620) was examined and compared with the A.S.C.S. photography taken in 1969. As to be expected, the larger scale of the earlier photos made recognition of subsidence features somewhat easier. Moreover, the older photography in one case (Shamrock mine) showed subsidence pits which were not visible on the more recent photo coverage. Further investigation showed that between the two dates of photography an extensive program of pit-filling and land-leveling was carried out by local ranchers in cooperation with the Soil Conservation Service (U.S.D.A.). The older photos prove that, in at least one area, subsidence did occur even though present-day surface evidence of subsidence is lacking.

A photo comparison was also made of areas where new coal mining had taken place during the time spanned by the two dates of photography. The later photography did not show any subsidence features over the newly undermined areas. The lack of subsidence evidence in these areas leads to two very different

conclusions. The first, and most obvious, is that no subsidence occurred over the areas mined between 1949 and 1969. The second conclusion is that subsidence has occurred, but that its effects on the surface are subtle and diffuse. The fact that the areas mined during the period 1949-1969 generally had an overburden thickness of more than 200 feet lends support to the second possibility.

Low-Sun-Angle Photography - Through the cooperation of the U. S. Geological Survey, a number of large scale, low-sun-angle aerial photographs of selected areas in the coalfield were obtained. The photos were taken on July 23, 1974 during the early morning (7:00-8:30 AM), while the sun was still low on the horizon. The low angle of the sun caused ground features of low relief to cast long shadows, and it was hoped that these shadows would enhance the outlines of the shallow depressions, pits, and swales which so frequently indicate subsidence.

The areas selected for low-sun-angle photography included a control area of well-known and well-defined subsidence and a half dozen areas where there was doubtful evidence of surface subsidence. The photos used for study have a scale of approximately 1"=450' (1:5450) and were made by enlarging 2.25" X 2.25" negatives. Enhancement is most apparent in the control area at Marshall and can be seen by comparing Figures 29 and 31 with Figures 30 and 32. The former were made from a photo taken



Figure 29. A.S.C.S. photo of
area A, south of Marshall
High-sun-angle Photo



Figure 30. U.S.G.S. photo of
area A, south of Marshall
Low-sun-angle Photo

The shadows on the low-sun-angle photo enhance the outline of collapsed rooms at a and b. The same features (a', b') are nearly indiscernible on the high-sun-angle photo. The subsidence pits at c (c') are also more strongly enhanced on the low-sun-angle photo. The two figures are both enlargements and have an approximate scale of 1"=450' (1:5450). The enhancement of detail brought about by enlargement is seen by comparing Figures 6 and 29, both of which were made from the same negative.



Figure 31. A.S.C.S. photo of
area B, north of Marshall
High-sun-angle Photo



Figure 32. U.S.G.S. photo of
area B, north of Marshall
Low-sun-angle Photo

Collapse features a (a') outlining the rooms and pillars of the Lewis No. 1 and 2 mines are enhanced by the shadows of the low-sun-angle photo. The same features become blurred on the high-sun-angle photo because of the large amount of light reflected from the bare rock near mid-day. For the same reason, subsidence induced joints at b (b') are also better displayed on the low-sun-angle photo. Joints at b (b') are also shown in foreground of Figure 8 and flume c (c') of irrigation ditch is in middle ground of Figure 9. The figures above are enlargements and have an approximate scale of 1"=450' (1:5450). Figures 6 and 31 were made from the same negative. A comparison of the two shows the enhancement of detail brought about by enlargement.

when the sun was high above the horizon; the latter were made from a low-sun-angle photo. Subsidence pits, room and pillar outlines, and subsidence induced fractures are all better expressed on the low-sun-angle photos than on the more conventional photos. The use of low-sun-angle photography to relieve the doubt surrounding "subsidence" features in other parts of the coalfield was less successful. Features which appeared doubtful when visited in the field (Figure 17) still seemed doubtful when observed on the photos.

This study has shown that aerial photographs have a number of applications, as well as some limitations, in mine subsidence investigations. Repetitive photo coverage can provide a historical record of where subsidence has occurred in the past and, to some extent, when it occurred. It can also show where the effects of subsidence have been masked by the later work of time and man. A major constraint on the use of aerial photographs as a means of determining past subsidence history is that the dates at which the various photo coverages were flown are not necessarily the dates of greatest mining activity.

In areas of shallow (less than 100 feet) mining, subsidence features are strongly developed and can easily be recognized on air photos. Recognition is made easier by using low-sun-angle photography and by enlargement of the photos. The effect of enlargement is strikingly shown by comparing Figure 6 with

Figures 29 and 31. The latter are merely enlargements of the former, but the subsidence features which they show have been greatly enhanced by an increase in perceived depth and detail. It should be noted that there is a trade-off involved when one is choosing between large and small scale photos. Large scale photos show subsidence features very well, but require a large number of photos to cover a given area. Fewer small scale photos are needed to cover the same area, but there is a greater likelihood of overlooking subsidence features.

In areas of deep (more than 200 feet) mining, well-defined depressions and subsidence pits are lacking and subsidence as expressed at the surface is probably too subtle to detect by normal photo interpretation methods. It is possible that such subtle subsidence might be identified by using sophisticated photogrammetric plotters in conjunction with large scale photographs taken before and after an area was undermined. Good plotters can measure very small differences in elevation, and changes of only a foot or two over newly mined areas could probably be detected. The use of photos as a future historical record is limited by the costs of obtaining ground control, the costs of repetitive flying, and the costs of plotting machine time.

VIII. LAND-USE PLANNING AND MINE SUBSIDENCE

Background

Mining activity in the Boulder-Weld coalfield started in the early 1860's in the Marshall area and presently continues only in the Eagle mine. Although instances of subsidence had been recognized for many years, little thought was given to the relationship between underground mining, subsidence, and man-made structures on the surface. Towns in the coalfield were small, and rural housing was widely scattered. Subsidence could take place and go unnoticed, and damage to existing, relatively small structures could easily be repaired. Fields and roads could be regraded and kept in usable condition. These inconveniences apparently were not of sufficient magnitude or intensity to cause widespread concern, and subsidence-related problems were accepted as a part of life and were dealt with as they occurred. The subsidence-hazard issue remained one of limited interest until recently, when accelerated population growth throughout the region produced significant increases in the density of residential development in-and adjacent-to undermined areas.

Due to increased emphasis on land-use planning, and to expanding development pressures, it has become apparent that a close look must be taken at areas of potential subsidence. The

increasing concern for the wise and safe development of land is reflected in the passage of House Bill 1041 by the 1974 Colorado General Assembly. This law has brought subsidence problems (classified as a natural hazard) within the purview of the State, as well as the county and municipality.

When considering land use in areas which have been undetermined, the following questions must be addressed.

1. Is or was there coal under the tract to be developed?
2. Has the full amount of subsidence occurred over worked-out areas, or can more subsidence be expected?
3. If more subsidence can be expected, when will it occur, and what will be its magnitude?
4. In an area in which subsidence is likely to occur, can remedial measures be taken so that the land can be developed safely?
5. What are the legal problems likely to be associated with land development in- and adjacent- to areas of potential subsidence?
6. Will advancing technology make it feasible to re-enter old mines?

This list of questions is not complete, but it illustrates the complexity of the problem.

Since the Boulder-Weld coalfield is in the path of Front Range urbanization, it is timely that answers to the above questions be found. Some of the questions are quite complex, and it

will not be economically practical to obtain answers for them. In such cases, the land in question may best be left as open space or greenbelt. When answers to land subsidence problems are not clear cut and definitive, the potential land developer should follow a program of investigation which, hopefully, will provide the data needed. The first step in such a program would be to study the maps which accompany this report, particularly the subsidence-hazard map.

Certain areas, because of land ownership or because of proximity to previously developed areas, will be subject to considerable pressure for development. In these areas it will be necessary to undertake detailed, and relatively expensive studies to determine the extent to which viable and safe development is feasible.

Subsidence-Hazard Map

Purpose and Procedures - The purpose of the subsidence-hazard map is to designate, insofar as possible, those areas where development of the land surface may be affected by subsidence related to undermining. The most direct approach to the preparation of a subsidence-hazard map would be to compare and contrast information on the various mining factor maps with data on the subsidence-inventory map. Comparisons were made with this objective in mind to determine if any positive correlations

existed. It was hoped that such correlations would identify those factors which are most critical to the development of subsidence.

Instances of known subsidence were evaluated with respect to the following factors and combinations of factors:

1. Presence or absence of pillars
2. Depth of cover
3. Probable thickness of extracted coal
4. Dates of mine operation
5. Proximity to mapped faults
6. Presence or absence of pillars plus probable thickness of extracted coal
7. Presence or absence of pillars plus proximity to mapped faults
8. Depth of cover plus probable thickness of extracted coal
9. Depth of cover plus proximity to mapped faults
10. Depth of cover plus presence or absence of pillars.

A positive relationship was observed only between depth of cover and the presence or absence of pillars (No. 10).

1. In the depth-of-cover range 0-100 feet, instances of surface subsidence evidence occur just as often over areas where pillars are absent as over areas where pillars are present.

2. In the depth-of-cover range 100-200 feet, instances of surface subsidence evidence occur twice as often over areas where pillars are absent as over areas where pillars are present.
3. In the depth-of-cover range 200-300 feet, instances of surface subsidence evidence occur three times as often over areas where pillars are absent as over areas where pillars are present.
4. In cases where the depth of cover is greater than 300 feet, instances of surface subsidence evidence occur twice as often over areas where pillars are absent as over areas where pillars are present.

These observations indicate that, as depth of cover increases to 300 feet, the occurrences of subsidence evidence over areas where pillars are absent become increasingly more frequent relative to those areas where pillars are present. Below 300 feet this trend is reversed, possibly due to the increased "bridging" effect provided by a thicker overlying rock section.

It should be stressed that comparisons can be made only where evidence of subsidence exists. In areas where there is no surface evidence of subsidence, any conclusions drawn from the above observations should be used with great caution. This is particularly true with any attempts to relate the possibility of future subsidence to depth of cover and the presence or absence of mine pillars.

The almost total lack of correlation in the above comparisons (Nos. 1-9) is probably due to the complexity of the relationship which exists between room-and-pillar mines and surface subsidence. In addition, the records kept throughout the years of mining activity in the area are not sufficient for a thorough analysis of the relationship between subsidence and other mining factors. Another major problem is that the subsidence-inventory map shows only observed subsidence, and does not record subsidence which may have gone unnoticed. It is possible that had a full and accurate record of subsidence been available, some correlations might have been established.

Basic Assumptions Used in Map Construction - The problems described above indicate that no consistent rule can be adopted for predicting subsidence. The best approach appears to be one which is based upon the probable relative severity of potential subsidence in any given area. Since any undermined area may be affected by subsidence or post-subsidence settlement, all such areas have been assigned a degree-of-hazard classification based on the following simple assumptions:

1. Large undermined areas with no support (ie. pillars removed) subside shortly (within months) after support is removed.
2. Caving proceeds upward from the mine roof, and by the time subsidence effects have been transmitted

to the surface it can be expected that no large voids remain beneath that particular area.

3. Occurrences of partial collapse (that is, cases where subsurface caving has occurred, but where the caving has not reached the surface) were not detected during this study. Therefore, it is assumed that, where surface subsidence has occurred, the subsidence is essentially complete. This does not include post-subsidence compaction and attendant surface settling.
4. The inability to confidently predict the relative stability of a given undermined area requires a conservative approach to hazard classification. Accordingly, it has been assumed that pillars left standing after mining ceased will undergo deterioration with time, and will eventually fail. The amount of time required for a pillar to completely deteriorate will depend on many factors, which vary in importance in different areas of the coalfield. Eventually, all pillars will probably fail, and subsidence will probably occur over all voids in the study area.

Hazard Classification System - Using the above assumptions, a classification system has been established to define the degree

of subsidence hazard in relative terms. This appears to be the most useful approach to the problem of the relationship between land subsidence and land use. The categories of subsidence hazard are severe, moderate, and low.

1. Severe - Areas labelled "severe" are those in which rapid and violent subsidence effects may endanger occupants of the area by causing the failure of building foundations, roadways, gas mains, and similar man-made features. These areas are characterized by either 1) the presence of pillars (which are assumed to be undergoing decomposition) plus physical evidence of void space, or by 2) the absence of evidence of surface subsidence. The collapse of decomposed pillars could alter the complex stress and strain patterns in the overlying rock. This could initiate almost instantaneous local surface subsidence or displacement, thereby causing equally rapid destruction of structures in the area. The only acceptable land use for these areas, without undertaking relatively expensive remedial measures, are agriculture or open space.
2. Moderate - Areas subject to "moderate" subsidence are those in which the effect of subsidence might be sufficient to render man-made structures unsafe or

unusable. The rate of subsidence would probably be slow enough to allow time for recognition of the problem, and if necessary, for the safe and orderly abandonment of the area. Possibly, there would be sufficient time for remedial action which could offset the effects of the subsidence. "Moderate" areas are characterized by the presence of subsidence features over undermined areas where pillars are reported to be present. This condition produces the potential for further subsidence and differential settlement. Appropriate land uses would include agriculture, open space, open storage areas, unoccupied warehouses, and similar uses which would require only a low population density.

3. Low - Areas of "low" hazard are those in which the rate and magnitude of any anticipated surface displacement would be small enough to warrant repair of affected existing structures. By using adequate engineering design, future structures in these areas could be built to withstand the anticipated stresses on their foundations. Below these areas, all or essentially all, pillars have been removed, and relatively uniform and complete subsidence has already occurred. Problems in such areas would be reduced mainly to post-subsidence compaction and related

surface settling. The only restrictions placed on land use would be the requirement that structures planned for these areas would be designed to withstand any small movements which might be induced by post-subsidence compaction.

Safety Factor - Factors such as angle of draw, attitude of bedding, and presence of zones of weakness due to faulting can extend the surface influence of a particular void well beyond the limits of the undermined area. Determination of the extent of subsidence at the surface is further complicated by the possibility of significant inaccuracies in the original mine maps.

The effect of the inter-relationship of the above factors is not amenable to quantification. It is therefore prudent to incorporate a "safety factor" into the determination of the extent of surface area which might be affected by mining. This has been done by assuming a nominal angle of draw (35°). This angle was used in conjunction with the maximum mining depth (580 feet) recorded in the coalfield to calculate the width (400 feet) of a safety zone which extends beyond the mine boundaries. This 400 foot wide safety zone is used throughout the entire coalfield even though nearly all mines are less than 580 feet deep. The hazard classifications used for the zones of safety are the same as those used for the adjacent areas which are directly over the mine.

Where faults, or intersections of faults, lie only a short distance beyond the 400 foot boundary, the zone of safety has been extended to those faults and intersections. Small modifications in the width of the zone have also been made based on surface topographic control.

Reclassification of Subsidence Hazard of Specific Areas - The hazard classification of all areas within the coalfield was based on the data available for this study. Reclassification of any part of these areas could be justified by the accumulation of more or better information. Such information might be derived from 1) more detailed maps than those available for this study, 2) field observations and measurements of additional subsidence not observed during this study, and 3) subsurface techniques such as core drilling and geophysical surveys. It is certain that the economic attractiveness of land development in the coalfield area will prompt investigations to re-define the subsidence hazard in- and adjacent- to specific properties.

Planning Review of Subsidence Hazards of Specific Areas

During the early stages of this study, it was hoped that a set of guidelines could be developed for use by those persons investigating the subsidence hazards of specific areas. It later became apparent that the complexity of the problems associated with subsidence was such that the most reasonable approach

to further investigations would be to acquire additional data similar to, but much more detailed than, that used in the preparation of this report. The preferred map scale on which to display the detailed data would be 1"=200' (1:2400).

For most areas, the development of large-scale maps showing basic data such as extent of mining, depth of cover, pillars, probable thickness of extracted coal, and subsidence occurrences will be only the first step in a land-use compatibility investigation. In some instances, the basic data will indicate that further investigations will be needed to demonstrate the viability of development. As in the case of hazard reclassification, such additional investigations will probably consist of subsurface testing through core drilling and geophysical surveys.

Subsurface investigations are expensive, and it should be expected that land development projects in the coalfield will be subject to some financial burdens not associated with projects of similar size in other areas. However, the area still appears to be attractive for development, and the more astute engineers, designers and planners will find ways to overcome the problems which exist.

IX. CONCLUSIONS

1. Much of the land between the towns of Marshall (Boulder County) and Firestone (Weld County) is now undermined with abandoned coal workings.
2. The workings lie at depths which range from 30 to 580 feet. Most are within the 100 to 300 foot depth range.
3. The coal mines were worked by the room-and-pillar method rather than by the longwall method. In most cases, the miners attempted to "pull" as many of the pillars as they could during the later stages of development in any given mine.
4. Most of the theories of coal mine subsidence and most of the methods of predicting the time, duration, and extent of subsidence are derived from European experiments and observations in longwall mines. These theories and predictive methods are not entirely applicable to the room-and-pillar mines of the Boulder-Weld coal-field. This is because the presence of unpulled pillars (even in so-called "worked out" mines) disrupts the orderly development of subsidence and introduces a great deal of uncertainty as to the time of subsidence relative to the time of mining.

5. The extent of subsidence in the coalfield can be fairly well defined by field observations. Strong evidence of surface subsidence consists of well-defined pits and depressions; less definitive evidence consists of broad swales and shallow, poorly drained depressions.
6. Unequivocal evidence of subsidence is often observed on the surface in those areas where the mining depths do not exceed 200 feet. In areas where mining depths are greater, surface subsidence is not readily observable by the unaided eye, even though its presence could logically be expected. Precise surveying in such areas might detect shallow, closed depressions and might show that previously established benchmarks have subsided.
7. Observed damage to homes, streets, buildings, highways, and irrigation ditches should not automatically be ascribed to subsidence because, in many cases, the damage could be induced in other ways.
8. Interviews with local residents and miners are often helpful in locating surface subsidence features and in determining the time and duration of subsidence occurrences. However, it should be noted that memories of events which occurred 30 to 40 years ago are sometimes

uncertain, and that reports of subsidence must be cross-checked through field observations or through other interviews.

9. In some cases Federal government aerial photography is helpful in studying subsidence in the coalfield. Because the scale (1"=1667', 1:20000) of these photos is quite small, relative to the size and depth of the subsidence features being investigated, interpretation of subsidence is often uncertain. Nevertheless, a study of various sets of aerial photo coverage taken over the years (1937-1969) by different government agencies could provide a rough historical record of subsidence development in the coalfield since the late 1930's.
10. Low-sun-angle aerial photos, taken early in the morning, are a decided improvement on the normal government photography because the long shadows cast at that time of day enhance the outlines of low-relief subsidence features. In the detection of subsidence, the low-sun-angle photos are not a significant improvement over on-the-ground field observations.
11. There appears to be little correlation between instances of surface subsidence and other mining factors such as

depth of cover, presence or absence of pillars, and probable thickness of extracted coal. There does seem to be a relationship between cases of surface subsidence and depth of cover coupled with the presence or absence of pillars.

12. A classification of "severe," "moderate," and "low" hazard has been adopted for all undermined areas in the coalfield. These areas and their ratings are shown on a subsidence hazard map. The three categories of hazard are based on estimations of the relative amount of danger to which persons and structures in a given area might be subjected should subsidence occur in the future.
13. When specific properties in the coalfield are considered for development, an examination of the subsidence hazard map will give a first approximation as to the feasibility of the project. In most cases, more detailed information than is given in this report will have to be acquired. Much of this data will have to be derived from test drilling and geophysical surveys and its acquisition will undoubtedly be expensive.

X. SELECTED REFERENCES

- Averitt, P., and Lopez, L., 1972, Bibliography and index of U.S. Geological Survey publications relating to coal, 1882-1970: U.S. Geol. Survey Bull. 1377, 173 p.
- Babcock, S. D., 1973, Undermining as an element in land use planning [M.S. thesis]: Edwardsville, Southern Illinois Univ., 84 p.
- Brauner, G., 1973, Subsidence due to underground mining (In two parts) 1. Theory and practices in predicting surface deformation: U.S. Bur. Mines Inf. Circ. 8751, 56 p.
- _____, 1973, Subsidence due to underground mining (In two parts) 2. Ground movements and mining damage: U.S. Bur. Mines Inf. Circ. 8572, 53 p.
- Candeub, Fleissig and Associates, 1971, Demonstration of a technique for limiting the subsidence of land over abandoned mines, N.T.I.S., Tech. Rept., P.B. 212708, 57 p.
- _____, 1973, Demonstration of a technique for limiting the subsidence of land over abandoned mines, final report: City of Rock Springs, Wyo., 28 p.
- Colorado Division of Mines, 1973, Coal 1973: Colo. Div. Mines Inspection Div., 28 p.
- Colorado Springs Planning Department, 1967, Mining report, Colorado Springs coalfield, a guide for future land use: Colorado Springs Planning Dept., Geol. Sec., 10 p.
- Colorado State, 1963, Coal mining laws: State of Colorado, revised statutes, chap. 92, pt. 1, arts. 1-12, sec. 1, 124 p.
- Colton, R. B., and Lowrie, R. L., 1973, Map showing mined areas of the Boulder-Weld coalfield, Colorado: U.S. Geol. Survey Misc. Field Studies Map MF-513.
- Dunrud, C. R., and Barnes, B. K., 1972, Engineering geologic map of the Geneva Mine area, Carbon and Emery Counties, Utah: U.S. Geol. Survey Misc. Geol. Inv. Map I-704.
- Flaschentrager, H., 1958, Considerations on ground movement phenomena: Colliery Eng., v. 35, no. 8, p. 342-350 and no. 9, p. 391-398.

- Gillen, G., 1974, When coal was king: Focus Magazine in Boulder Daily Camera, March 24, 1974, p. 3-6.
- Grosvenor, N. E., 1964, Coal mines of Colorado, Adams County (map): Colorado Sch. of Mines Found., Golden, Colo.
- _____ 1964, Coal mines of Colorado, Boulder County (map): Colorado Sch. of Mines Found., Golden, Colo.
- _____ 1964, Coal mines of Colorado, Weld County (2 maps): Colorado Sch. of Mines Found., Golden, Colo.
- Herbert, C. A., and Rutledge, J. J., 1927, Subsidence due to coal mining in Illinois: U.S. Bur. Mines Bull. 238, 59 p.
- Holt, R. D., 1972, Bibliography, coal resources in Colorado: Colorado Geol. Survey Bull. 34-A, 32 p.
- Hornbaker, A. L., and Holt, R. D., 1973, Coal resources of Colorado, 1972 summary of: Colorado Geol. Survey Spec. Pub. no. 3, 15 p.
- Hutton, T., 1956, Deep hole closes Lafayette street as old mine caves in: Denver Post, May 27, 1956.
- King, H. J., and Whetton, J. T., 1958, Mechanics of mining subsidence: Colliery Eng., v. 35, no. 6, p. 247-252 and no. 7, p. 285-388.
- Landis, E. R., 1959, Coal resources of Colorado: U.S. Geol. Survey Bull. 1072-C, p. 131-232.
- Litwiniszyn, J., 1958, The theories and model research of movements of ground masses: Colliery Eng., v. 35, no. 10, p. 438-444.
- Lowrie, R. L., 1966, Analysis of the coal industry in Boulder-Weld coalfield, Colorado: U.S. Bur. Mines Rept. Inv. 6726, 79 p.
- Malde, H. E., 1955, Surficial geology of the Louisville quadrangle, Colorado: U.S. Geol. Survey Bull. 996-E, p. 217-257.
- Martin, S. C., 1910, Coal of the Denver basin, Colorado: U.S. Geol. Survey Bull. 381-C, p. 297-306.
- Mohr, H. F., 1956, Influence of mining on strata: Mine and Quarry Eng., v. 22, no. 4, p. 140-152.

- National Coal Board, 1966, Subsidence engineer's handbook:
National Coal Board - Production Department, London, 118 p.
- Panek, L. A., 1973, Program for control of surface subsidence:
U.S. Bur. Mines Prog. Rept., no. 10011, 23 p.
- Perez, W., 1958, Subsidence observations in Austria: Colliery
Eng., v. 35, no. 11, p. 479-482 and no. 12, p. 533-535.
- Scott, G. R., 1962, Geology of the Littleton quadrangle,
Jefferson, Douglas, and Arapahoe Counties, Colorado:
U.S. Geol. Survey Bull. 1121-L, 53 p.
- Smith, R. O., Schneider, P. A., Jr., and Petri, L. R., 1964,
Ground water resources of the South Platte River basin in
western Adams and southwestern Weld Counties, Colorado:
U.S. Geol. Survey Water-Supply Paper 1658, 132 p.
- Soister, P. E., 1965, Geologic map of the Fort Lupton quad-
rangle, Weld and Adams Counties, Colorado: U.S. Geol.
Survey Geol. Quad. Map GQ-397.
- _____, 1965, Geologic map of the Hudson quadrangle, Weld and
Adams Counties, Colorado: U.S. Geol. Survey Geol. Quad.
Map GQ-398.
- _____, 1965, Geologic map of the Platteville quadrangle, Weld
County, Colorado: U.S. Geol. Survey Geol. Quad. Map GQ-399.
- Spencer, F. D., 1961, Geologic map of the bedrock geology of
the Louisville quadrangle, Colorado: U.S. Geol. Survey
Geol. Quad. Map GQ-151.
- Stefanko, R., 1973, Subsidence and ground movement, in S.M.E.
handbook: Soc. Mining Eng., Am. Inst. Mining, Met. and
Petr. Eng., Inc., New York, p. 13-2 to 13-9.
- Turnbull, D., and Potts, E. L. J., 1958, Surface and underground
subsidence correlation: Colliery Eng., v. 35, no. 2,
p. 65-72.
- Van Horn, R., 1957, Geologic map of the bedrock geology of the
Golden quadrangle, Colorado: U.S. Geol. Survey Geol.
Quad. Map GQ-103.
- Weimer, R. J., 1973, A guide to uppermost Cretaceous stratig-
raphy, central Front Range, Colorado: Mountain Geologist,
v. 10, no. 3, p. 53-97.

- Wells, J. D., 1967, Geology of Eldorado Springs quadrangle, Boulder and Jefferson Counties, Colorado: U.S. Geol. Survey Bull. 1221-D, 85 p.
- Woodhuff, S. D., 1966, Methods of working coal and metal mines, Vol. 2, Ground support methods: New York, Pergamon Press, 429 p.
- Yinst, P. O., 1960, Coal resources of Colorado: Colo. Sch. Mines Min. Ind. Bull., v. 3, no. 5, 8 p.
- Young, C. M., 1917, Percentage of extraction of bituminous coal with special reference to Illinois conditions: Univ. Illinois Engineering Experiment Station Bull. 100, 175 p.
- Young, L. E., 1916, Surface subsidence in Illinois: Illinois Geol. Survey Bull. 17, 112 p.
- _____ and Stoek, H. H., 1916, Subsidence resulting from mining: Univ. Illinois Engineering Experiment Station Bull. 91, 205 p.
- Zwartendyk, J., 1971, Economic aspects of surface subsidence resulting from underground mineral exploitation [Ph.D. thesis]: University Park, Pennsylvania State Univ., University Microfilms, Ann Arbor, 411 p.

APPENDIX A

CITY, COUNTY, STATE AND FEDERAL OFFICIALS; MINERS; LOCAL RESIDENTS AND OTHERS INTERVIEWED DURING COAL MINE SUBSIDENCE STUDY

City and County Governments

Brouillette, Jason, Boulder Co. Planning Dept., Head
of Operations

Heffington, William, Boulder Co. Eng. Dept.

Pendleton, James, City of Boulder, Geologist

Bedford, James, City of Lafayette, former Mayor

Deppe, Daniel, City of Lafayette, Ass't. City Manager

White, Daniel, City of Louisville, City Engineer

Wurl, Leon, City of Louisville, City Administrator

Lorenson, Burman, Weld Co. Planning Dept., Planning
Director

Olsen, Gill, Weld Co. Engineer's Office

Colorado State Government

Deborski, Andrew E., Colo. Div. of Mines, Chief Coal
Mine Inspector

Platt, Thomas, Water Commissioner, Dist. 6

Gilmore, John, State Highway Dept., Geologist, Denver
Region

Bower, Dwight, State Highway Dept., Engineer, Dist. 4

Springer, John, State Highway Dept., Maintenance Ass't.,
Dist. 4

U. S. Government

Dunrud, C. Richard, U. S. Geological Survey

Colton, Roger B., U. S. Geological Survey

Appendix A - Continued

U. S. Government (Cont.)

Panek, Louis A., U. S. Bureau of Mines
Morgan, Thomas A., U. S. Bureau of Mines
Darnell, Richard, U. S. Bureau of Mines
Donner, Donald, U. S. Bureau of Mines
Moreland, Donald, Soil Conservation Service, U.S.D.A.

Active and Retired Miners

Astle, John, Lincoln Mine, General Manager
Amicarella, Lawrence
Clyncke, Marion
Clyncke, Oliver
De Novellis, Anthony
De Vischer, Andy
Dhieux, August
Ferguson, William, Lincoln Mine, former Mine Superintendent
Gunther, Wilbur, Imperial Coal Co., General Manager
Hawkins, Henry
Kolar, Frank, Eagle Mine, former Mine Superintendent
Miller, Manford
Reese, Charles, Eagle Mine, Mine Superintendent
Sidle, Samuel
Stolns, Edward, Lincoln Mine, Mine Superintendent
Vaughn, Ambrose

Appendix A - Continued

Local Residents

(Mrs.) Amicarella, Librarian, Lafayette
Barlow, Niles, resident, Lafayette
Bateman, Albert, owner of property above Electric Mine
Coonts, Phyllis, resident, Marshall
Dhieux, Vivian, City Councilwoman, Louisville
Di Giacomo, Susie, owner of property above Paramount Mine
Lewis, K. D., homeowner near Shanahan Mine
Ostdiek, Walter, Paclamar Farms, Louisville
Reichert, A. E., owner of property above Black Diamond Mine
Rodelli, James, resident, Superior
Sampson, Johana, resident, Marshall
Waremburg, Clubert, owner of property above Acme Mine
Zabler, (Mrs.) R. A., resident, Lafayette

Miscellaneous

Boyle, Clyde, Charles Robinson and Associates
Cochran, Dale, Charles Robinson and Associates
Darnell, Clinton, Adolph Coors Co., Engineer on Coors
Pipeline
(Mr.) Ferryman, Burlington Northern and Colorado and
Southern RR, Chief Engineer
Gillen, Gary, Boulder Daily Camera
McPhail, Donald, Univ. of Colorado, Professor

Appendix A - Continued

Miscellaneous (Cont.)

Miller, Dean, Public Service Co. of Colo., Supervisor,
Transmission Engineering

Rahmiamian, Victor, Colo. School of Mines, graduate
student

Russell, William, Rocky Mtn. Energy Co., Senior Engineer

Sarchet, M. C., Former Reservoir and Irrig. Co.,
President

Schreiner, Robert, Centaurus High School, Principal

Waneka, George, Waneka and Sons Drilling Co.

Weimer, Robert, Colo. School of Mines, Professor