

GEOECOLOGY OF SOUTHERN HIGHLAND PERU

A Human Adaptation Perspective

Bruce P. Winterhalder • R. Brooke Thomas



PERUVIAN AND UNITED STATES
PROGRAM ON MAN AND THE BIOSPHERE

Occasional Paper No. 27 1978
INSTITUTE OF ARCTIC AND ALPINE RESEARCH
UNIVERSITY OF COLORADO

The logo for the Man and the Biosphere (MAB) program, featuring a stylized symbol above the letters 'MAB'.

Unesco MAB Project 6



GEOECOLOGY OF SOUTHERN HIGHLAND PERU:
A HUMAN ADAPTATION PERSPECTIVE

by

Bruce P. Winterhalder
Program on Science,
Technology and Society
Cornell University
Ithaca, NY 14853

and

R. Brooke Thomas
Department of Anthropology
University of Massachusetts
Amherst, MA 01003

1978

A joint contribution to the Peruvian and United States
Unesco Man and the Biosphere (MAB) Program Project 6:
Study of the impact of human activities on mountain
and tundra ecosystems

University of Colorado
Institute of Arctic and Alpine Research

Occasional Paper 27

ISSN 0069-6145

INSTAAR/OP-27

Cover. In spite of their position as ecological dominants, rural groups perceive themselves as part of an integrated system of natural and cultural elements. Many environmental features and conditions are seen as having religious or human qualities. Here, an offering of coca and alcohol is being given to a mountain spirit and permission is being requested to pass over the summit.

Citation of this publication is Institute of Arctic and Alpine Research
University of Colorado, Occasional Paper No. 27, 1978.
© Copyright 1978, The Regents of the University of Colorado
All rights reserved.

TABLE OF CONTENTS

List of Illustrations	v
List of Tables	vi
Foreword	vii
Preface	xi
Acknowledgments	xiii
INTRODUCTION	1
GEOLOGY	3
CLIMATE	8
Precipitation	13
Temperature	20
Other Climatic Elements	24
SOILS	28
ENVIRONMENTAL STRESS AND ADAPTATION	32
FLORA	34
The Eastern Escarpment	35
The Western Escarpment	39
The Altiplano	39
FAUNA	47
HUMAN-ENVIRONMENT INTERACTION	52
The Nuñoa Ecosystem	53
Landscape	53
Climate Characteristics	55
Wild Plants	57
Domestic Plants	63
Domestic Animals	72
HUMAN MODIFICATION OF THE ENVIRONMENT	77
Environmental Degradation	77
Human Adaptation	79
Consequences of Change	82
REFERENCES CITED	85

LIST OF ILLUSTRATIONS

Figure 1.	Map of the <u>altiplano</u> and its location within South America.	4
Figure 2.	Generalized pattern of surface air flow and pressure areas over South America.	10
Figure 3.	Climatic data for Chuquibambilla (Department of Puno, 70°43'W, 14°47'S, 3910 m).	14
Figure 4.	Weather data for the District of Nuñoa (70°38'W, 14°28'S, 3974 m) for the period April 1964 to June 1966.	15
Figure 5.	Weather data for the town of Nuñoa in 1968 (3974 m).	16
Figure 6.	Instability of annual precipitation and temperature.	17
Figure 7.	Vertical zonation of agricultural vegetation types and frost climates in the Andes of southern Peru.	22
Figure 8.	Reduction in barometric pressure (a), in partial pressure of oxygen (b), and partial pressure of carbon dioxide (c) with increasing altitude, and increase of ionizing cosmic radiation with altitude (d).	26
Figure 9.	Great soil groups (FAO system) of the Nuñoa area.	30
Figure 10.	Geology of the Nuñoa area.	31
Figure 11.	Vegetation zones of the central Andes.	36
Figure 12.	Cross section of the equatorial Andes of Ecuador (above) and of the tropical Andes at the latitude of Lake Titicaca.	37
Figure 13.	Typical <u>altiplano</u> plants illustrating the lifeforms found in the highlands of southern Peru.	43
Figure 14.	Nuñoa district and its environs.	54
Figure 15.	Subclimatic types of the Nuñoa area.	58
Figure 16.	Ecological formations of the Nuñoa area.	59
Figure 17.	Vegetation associations of the Nuñoa area.	59
Figure 18.	Land-use capacity of the Nuñoa area.	62
Figure 19.	<u>Ichu</u> bunch grasses (<u>Stipa</u> sp.) predominate on the valley floors (4000 m) of the <u>altiplano</u> , while shorter grasses become more abundant at higher elevations, especially in the smaller valleys. The frost desert and snowfields lie above.	65
Figure 20.	Altitude limits of cultigens, natural vegetation and herd animals in Nuñoa.	65

LIST OF ILLUSTRATIONS (cont.)

Figure 21.	Most varieties of <u>quinoa</u> (center) and <u>cañihua</u> (right) are unaffected by a heavy snowfall.	67
Figure 22.	Most cultivation takes place on lower hillsides because they are less prone to frost.	69
Figure 23.	Considerable human effort is required to prepare potato fields.	69
Figure 24.	Animal dung is used both as fuel and as fertilizer.	70
Figure 25.	The hardy <u>amarga</u> potato is submerged beneath mats of straw and rock in the river in order to leach out its bitter taste.	70
Figure 26.	During the dry season, the low relative humidity and high isolation of daytime, and the freezing temperatures of nighttime provide the conditions for potatoes to be dehydrated.	71
Figure 27.	This residence with an adjoining corral is typical of rural families who live in dispersed settlement patterns.	75
Figure 28.	The availability of green pasture through the dry season appears to be an important factor influencing herd size.	75
Figure 29.	Simplified energy flow diagram of Nuñoa rural population.	76

LIST OF TABLES

Table 1.	Classification of pasture species according to quality.	64
Table 2.	Domesticated food sources in the Nuñoa ecosystem.	66

FOREWORD

A short version of this monograph was originally prepared for a summary collection of papers on human adaptation in the southern Peruvian Andes entitled Man in the Andes: A Multidisciplinary Study of High-Altitude Quechua, edited by P. T. Baker and M. A. Little (1976). For our own research, and for the general study of the theoretical and practical problems surrounding human ecology and adaptation in the Andes, we felt a more extensive discussion of the physical and biotic environment was desirable. Anthropological studies of these subjects are often presented with only a sketchy portrait of their environmental context. The relevant information is contained in a variety of disparate sources, often unavailable to the nonecological researcher and certainly unavailable in summary form. Consequently we have undertaken the provision of a specific introduction, within the general framework of the high-altitude environment of the southern Peruvian Andes, from an ecological and human adaptation perspective.

Our approach is broadly ecological. We consider the high-altitude environment as an ecosystem in which the human population is a dominant but interactive component. Our goal as anthropologists is to understand human adaptive responses to this environment, but we believe a greater understanding of the physical characteristics of the region which affect its flora and fauna is essential. Knowledge at this level contributes to the understanding of the human articulation with the local ecosystem, and the manner in which the relationship between the human population and that ecosystem has coevolved. An accurate characterization of human adaptation must take into account the details of the existing environment and present them in a generalizable terminology, and must also appreciate the historic and dynamic aspects of the environment that affect humans.

Theoretical concepts in ecology and anthropology have largely determined the framework of this report. However, in an immediate and practical sense its importance lies elsewhere. High-mountain environments are easily

degraded, and for a variety of reasons are presently undergoing fairly rapid deterioration. A generalized discussion of the characteristics of high-altitude ecosystems and human adaptations--one as ecologically comprehensive as we can currently make it--is increasingly necessary. Part of our goal is to highlight where, and to what great degree, our knowledge of essential matters is rudimentary. However, the objective also lies in the recognition that practical decisions will be made before the data base expands significantly, and in this respect an organized, if incomplete, summary should be useful. Problems with downslope movement of materials and with slow recovery of disturbed flora and fauna in high-altitude ecosystems are being exacerbated by changing use of the environment and growing human populations. Many of these populations are dependent on the continued integrity of the local environment for their subsistence. An absence of clear alternatives for their support makes the situation acute.

We should state forcefully that the magnitude of the theoretical and practical problems outlined above is in no sense commensurate with the thoroughness or generality with which we can treat the subject. Unfortunately, this is a rather modest contribution. It is meant to provide a structured orientation to what is known, and by implication, to what must be learned, which is the much larger category. We acknowledge the incompleteness of this present work in at least three respects:

(1). We do not have access to much of the literature published outside of the United States. For instance, we have only occasionally been able to draw on the growing literature being produced by Andean scientists. The joint Peru/U.S. Man and the Biosphere (MAB) publication of this monograph in Spanish and English is part of an effort to reduce the linguistic, institutional, and geographic barriers to exchange of information, skills, ideas, and priorities.

(2). We have not fully used the literature from ethnobotany or ethnoecology that explicitly recognizes the Andean natives' extensive knowledge of their own environment. This is a source of sophisticated ecological understanding, and anthropologists are beginning to produce a literature in this field.

(3). Finally, we recognize that research on ecological subjects in tropical mountains is just beginning. Human ecological studies are

equally recent, although for historical and disciplinary reasons the anthropological literature is comparatively extensive.

We hope that this monograph will provide a base from which more detailed studies will be initiated. It summarizes existing information, and at the same time, provides a conceptual and terminological framework to guide future work. As anthropologists our focus is on adaptive responses, primarily within the realm of learned behavior, society, and culture. We have used this perspective to generalize about the adaptive responses of numerous species to the highland environment. We intend for it to complement, rather than exclude, the more traditional genetic or physiological focus of biologists. The general structure of learned behavioral adaptations is less well understood than that of genetic or physiological ones, and it is here that a biological anthropologist can make a contribution to a synthetic understanding of adaptation in a region.

Throughout the monograph we have relied heavily upon the excellent data compiled by the Oficina Nacional de Evaluacion de Recursos Naturales (ONERN). A number of people and organizations have encouraged and assisted in the publication of this report: Jose Lizarraga Reyes, Director of ONERN and President of El Hombre y la Biosfera (MAB-PERU); Gisbert Glaser of the UNESCO/MAB Program in Paris, who ensured the translation of the Spanish edition, and Ann Stites of the Institute of Arctic and Alpine Research (INSTAAR, University of Colorado) who provided editorial assistance for the production of both editions. The U.S. National Committee for MAB through the United States Department of State contributed funds for the bilingual publication. Finally we are most indebted to Jack Ives, Director of INSTAAR and U.S. MAB 6A Chairman (Impact of human activities on mountain and tundra ecosystems) who, in large part, has made this publication possible.

B. P. W. and R. B. T.


PREFACE

The publication of this monograph as an Institute of Arctic and Alpine Research Occasional Paper is the product of a series of happy circumstances and coincidences arising largely from the participation of Professor Paul Baker, Pennsylvania State University, and myself, in the development of the Unesco* Man and the Biosphere (MAB) Program, Project 6: Study of the impact of human activities on mountain and tundra ecosystems. We both attended the formative meetings held in Salzburg (1973), Lillehammer (1973), La Paz (1974), and Kathmandu (1975), and this experience heightened our awareness of the difficulties of bridging the research chasm between the natural and the human sciences. This involvement also led to a special workshop held in Boulder, Colorado (1974), which resulted in the formation of the United States Directorate for MAB 6 and the acceptance of a recommendation to the U.S. National Committee for MAB that any development of an active U.S. research program in this area would recognize a special responsibility for furthering interdisciplinary studies of the tropical high mountains of South America. We also clearly understood that this alone was not enough. The challenge of synthesizing and publishing the vast amount of preexisting work, and of ensuring its accessibility to the relevant decision makers, will always be with us. The sponsoring of the current monograph by Bruce P. Winterhalder and R. Brooke Thomas, therefore, was a multi-faceted effort and it is particularly appropriate that it will also be published in Spanish, as a joint Peruvian-United States MAB 6 venture.

Finally, the identification of common themes and objectives between the Unesco MAB 6 project and the International Geographical Union Commission on Mountain Geocology renders this monograph as a highly appropriate contribution to the work of the latter as well. I hope

*United Nations Educational, Scientific and Cultural Organization.

that its publication will prove an inspiration to others such that many further attempts will be made to take a holistic view of major mountain environmental problems. This should help with the formulation of a more effective program to ensure protection and utilization of mountain lands, not only as magnificent landscapes in themselves, but as essential habitats for some of the more deserving and vital members of the human race.

A handwritten signature in black ink that reads "Jack D. Ives". The signature is written in a cursive, slightly slanted style.

Jack D. Ives
Chairman, U.S. Directorate for MAB 6A
Chairman, IGU Commission on Mountain
Geoecology
August, 1978

ACKNOWLEDGMENTS

We would like to express our gratitude to the numerous individuals who have assisted us in the collection of data for Nuñoa and surrounding areas. Among those we would especially like to thank are Antonio Santos Aragon, Victor Barreda M., Charles Hoff, and Michael Little. Carlos Zamora J. called to our attention and made available ONERN/CORPUNO reports on the Department of Puno; likewise Oliver Pearson and Carol Pearson Ralph provided us with an unpublished manuscript on vertebrate ecology for this area: we have relied heavily on both of these studies. Margaret Boothroyd and Bernd Lambert provided invaluable assistance in the preparation of the manuscript; Erica Melack produced most of the maps and illustrations. We are grateful to the following institutions which have supported phases of this research: the Cornell University Latin American Studies Program, the Pennsylvania State University, the State University of New York at Binghamton, the Wenner-Gren Foundation and the National Institute of Mental Health. Mr. Winterhalder received support in the form of a graduate fellowship from the National Science Foundation. Finally, we would like to acknowledge our continuing debt to Paul Baker and John Murra whose work on human adaptation and Andean life underlies many of the ideas presented here.

INTRODUCTION

The central Andes Mountains rise abruptly from the Pacific Ocean on one side, and from the Amazon Basin on the other. The west coast of the mountains, cooled by the north-flowing Humboldt Current, is a desert with a sparse loma vegetation. In contrast, the eastern escarpment with its equatorial warmth and rainfall is tropical forest. Between, in the mountains and intermontane valleys, lies a patchwork of habitats ranging from the desert to the rain forest, and the coastal to the alpine. Two themes are essential to the Andes: the youth of these mountains, and their massiveness, both vertically and geographically. Immature soils and recent biogeographical development are given complexity by rugged topography and close proximity of diverse ecological zones. These conditions are emphasized by contrast with the long-stable Amazon Basin.

The monograph that follows is a discussion of the high-altitude, mountainous environment in southern Peru. Geology, climate, soils, and natural and domesticated biota will be considered. Initially our description will be of the central Andes as a region and of the complex gradients of climate and vegetation, which cross this area northwest to southeast and northeast to southwest. These gradients then provide the environmental context for more detailed treatment of a limited geographic area surrounding the town of Nuñoa (Melgar Province, Department of Puno), an example of the highland region, or altiplano.

Since a full discussion of our topic is clearly impossible, we have attempted to partition the information we can present. Emphasis in the text will be on the complex set of interacting factors that combine to form an environment multiply heterogeneous in time, space, and pattern. The preponderance of descriptive data will be found in figures and graphs. We have also attempted to balance the presentation of normative data, which provide a general picture of an environment, with data representing environmental variability. The relative extremes of environmental variables are often critical in the study of adaptation. Where environmental factors are treated as stressors we will be concerned with their

frequency, intensity, duration, and regularity, and with the effect of these parameters on the variety of adaptive responses available to plants and animals. This review of highland environment and general biotic adaptation to the highland zone sets the context for the detailed treatment of human adaptation.

GEOLOGY

The Andes are part of a larger mountain system, the New World Cordilleras, that lie along the western edge of the two American continents from Alaska to Antarctica. The Andes themselves are 7250 km in length; the larger Cordilleran system measures over 15,000 km. Within South America the Andes form an enormous reversed question mark, curving from the northern coast of Venezuela around the western margin of the continent, southwest through Columbia and Ecuador, southeast through Peru, and due south for the full length of Chile. The extension of the Andes into Antarctica is known as the Palmer Peninsula (Darlington, 1965). Narrow in the north and south of the continent, the several chains of the Andes separate in central and southern Peru, eastern Bolivia, and northern Chile to accommodate broad, high-altitude valleys and plateaus collectively known as the altiplano (Figure 1). In this paper we will follow the definition of Pearson (1951), and consider the altiplano to be the treeless portions of the central Andes surrounding Lake Titicaca and Lake Poopo, above 3660 m of altitude. The Quechua term "puna," meaning elevated earth, is also used for the area defined as altiplano, although some authors extend this term to cover broader areas or life zones (see Pearson, 1951).

Jenks (1956) and ONERN/CORPUNO Vol. II (1965) have published general accounts of Andean geology and our description follows these authors. Geologic history of the central Andes begins in the Paleozoic era with a subsiding underwater basin (the pre-Andean geosyncline) located along western South America where the Andes are today. Through the Mesozoic era this geosyncline accumulated marine and continental deposits, and underwent several minor periods of tectonic activity and mountain building known as orogenies. The middle Cretaceous period was a time of worldwide mountain building (the Laramine Orogeny) and the Andean geosyncline underwent uplift, deformation (Incaico Folding), and intrusion of volcanic materials along its western portions. The great Andean batholith, a massive intrusion of igneous rocks which today underlies the western

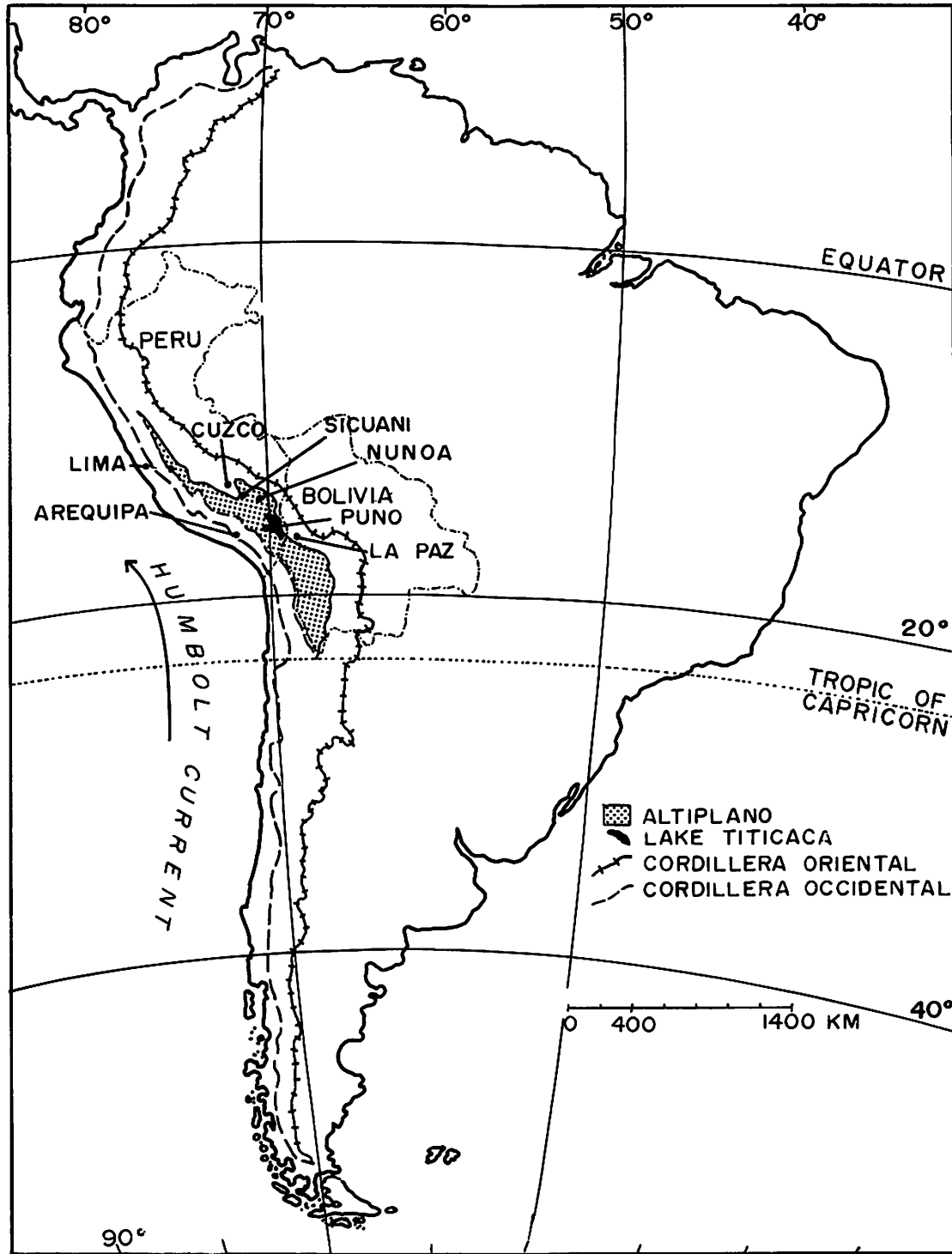


Figure 1. Map of the altiplano and its location within South America. (Reproduced with permission of the Institute of Ecology from Baker and Little, 1976.)

range (Cordillera Occidental), formed during this orogeny. To the east, geosynclinal rocks were laterally compressed, forming the folded stratigraphy that would eventually emerge as the eastern range (Cordillera Oriental). In the basin (Titicaca Trough) between the batholith and the eastern folding, sediments continued to accumulate until the Miocene or Pliocene. Volcanism (the No. 2 Puno Group) along the eastern margin of the geosyncline, and a late Tertiary orogeny were followed by a period of quiescence during which erosion reduced the Andean region to a mature, near sea-level surface (the Puna Surface). Beneath this landscape lay the complex of sedimentary, metamorphic, and volcanic formations that are exposed today as the structure of the Andes.

Formation of the present mountains began with uplift of the Puna Surface during the Pliocene and Pleistocene. Uplift took place in three episodes (Junin, Chacra, and Canon) separated by periods of standstill. In central Peru the Puna Surface was elevated to a general height of 4880 m, with monadnocks, mountain-like formations of material resistant to erosion, reaching as high as 6550 m. Peaks of comparable height in southern Peru are usually volcanoes built on flat lavas above a less strongly elevated Puna Surface. Normal thrust-faulting and extensive folding during uplift of the Andes produced the Titicaca and other interior basins. During the Lower Pleistocene the altiplano was covered by a vast lake (Lake Ballivian) which drained with the final uplift of the Andes to form Lake Titicaca. The actual timing of this event is not clear. Simpson (1968) places final uplift of the Andes in the late Pleistocene. Jenks (1956), citing evidence that only the most recent of the Pleistocene glacial phases affected the Andes, believes also that uplift was late. Vuilleumier (1971) however, mentions evidence for at least three major glaciations in Peru and places final uplift of the central Andes at the earlier Plio-Pleistocene boundary. In any case, the late Pleistocene to Recent has been an active volcanic period (the Sillapaca).

James (1973) has placed evolution of the Andean mountain system within the framework of plate tectonics. Briefly, the central Andes have resulted from the consumption of the oceanic Nazca Plate, which is expanding eastward from the East Pacific Ridge, beneath the continental

margin of the South American Plate, a process that began in the Jurassic. Subduction of the oceanic plate beneath South America has created the Peru-Chile Trench, and initiated the volcanism that provides much of the structure of the Cordillera Occidental. In addition, lateral pressure from the interaction of the Nazca and South American plates, as well as that generated by the massive intrusion of volcanic materials in the Cordillera Occidental, provided the forces which crumpled and elevated the Mesozoic geosynclinal rocks that make up much of the Cordillera Oriental. These two processes, growth by volcanism, and by lateral pressure, intensified about 15 million years ago when large intrusions of magma swelled the crust beneath the Andes, fostered the great volcanoes of the western mountain system, and by progressive growth of the volcanic chains to the east, crushed and elevated the geosynclinal materials of the eastern mountain system. During this period of formation sedimentary materials accumulated between the chains in the area now known as the altiplano.

Congruent with this recent interpretation, Jenks (1956) recognizes three "structural-morphological provinces" in the central Andes: the Cordillera Occidental (the western mountain system), the altiplano, and the Cordillera Oriental (the eastern mountain system). The Cordillera Occidental is composed of folded and mildly metamorphosed Mesozoic sediments from the Andean geosyncline resting on the Andean batholith. The higher parts of this mountain system are volcanoes of late Tertiary to Recent age. These include the "great Quaternary volcanoes" such as Coropuna and El Misti. The altiplano, an undulating plain with dispersed monadnocks of Devonian, Cretaceous, or Tertiary age, is built of vast accumulations of Cretaceous deposits and Tertiary volcanic material which fill the Titicaca Trough. The Cordillera Oriental, east of the Titicaca Basin, is formed predominantly of folded, faulted, and metamorphosed Paleozoic rock with Cretaceous and Tertiary intrusions of volcanic material. In general, the Andean geosyncline is now the site of a highly compressed mountain chain with strongly subdivided and differentiated igneous and stratigraphic rock units (Putzer, 1968).

The surface topography of these structural provinces is the result of more recent geological processes. Erosion and deposition, glacial

and tectonic activity, faulting, and volcanics are all active. The Cordilleras are characterized by deep V- and U-shaped valleys indicating strong alluvial and glacial erosion intensified by rapid uplift of the mountains and by faulting. Large mud- and rockslides are a constant and sometimes tragic reminder of the tectonic instability of these mountains. Northeast of Lake Titicaca, glacial valleys are recorded as low as 4000 m, and the authors have seen U-shaped valleys and glacial striations at about the same altitude near Nuñoa. Drainage from the eroding mountains into the intermontane basins and Lake Ballivian has leveled the altiplano with alluvial and lacustrine deposits. Outwash material from Pleistocene glaciations and lacustrine and fluvial terraces from the former Lake Ballivian have contributed to this leveling. Rivers continue to fill Lake Titicaca with sediments, although many valleys have not been eroded to a depth they had prior to filling with glacial outwash. All of these processes have combined to produce a rugged and youthful landscape, exposing a variety of stratigraphic rock types and igneous material that are undergoing strong erosion in mountains and deposition in the lower areas.

CLIMATE

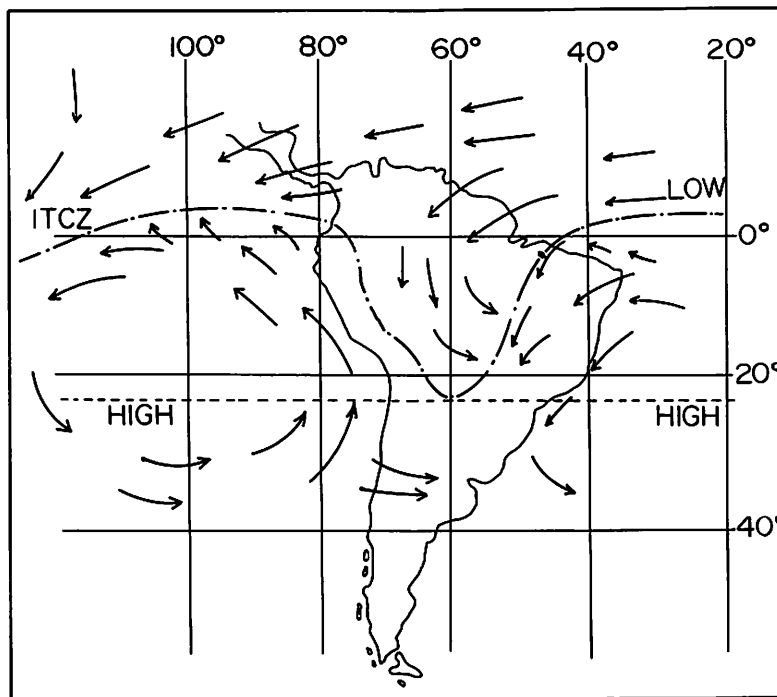
Circulation patterns, astronomical position on the earth, and surface features such as altitude and exposure are the major variables affecting climate (Eidt, 1968). Related to these external factors are climatic elements such as temperature, precipitation, atmospheric pressure, and cloud cover. The central Andes, located at the division of two major air masses within the tropical latitudes and composed of a rugged, high-altitude topography, provide a unique situation for the interplay of the variables mentioned by Eidt. These will be discussed in some detail before going on to the climatic elements. Our description in this section relies on background information provided by Garbell (1947), ONERN/CORPUNO Vol. I (1965), and Eidt (1968).

The Andes reach high into the layer of atmosphere containing most weather phenomena (the troposphere) and they extend from north of the equator to 50°S. For this reason the mountains sharply divide the major air masses of the western southern hemisphere (Schwabe, 1968). To the west of the Andes is the South Pacific anticyclone (a high pressure air mass with counterclockwise circulation of winds) centered over the Tropic of Capricorn during the northern solstice season.* A corresponding displacement of the South Atlantic anticyclone from the Tropic of Capricorn to 28°S occurs off the coast of Brazil during the southern solstice season (Figure 2). As these two anticyclones move south, a warm and moist low pressure air mass (cyclone) forms over the Amazon Basin, and the intertropical convergence zone (ITCZ) migrates south over the continent until it lies along the eastern escarpment of the Andes.

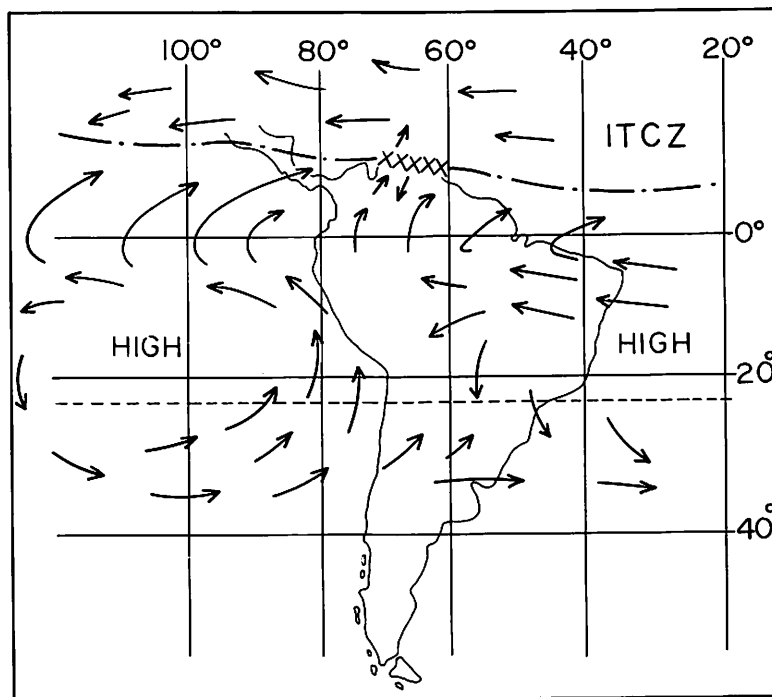
*To avoid the confusion of using seasonal terminology which is different in the northern and southern hemispheres, we will generally speak of solstice seasons. The northern solstice season (March 21 to September 20) is the period when the sun is north of the plane of the earth's equator, and the southern solstice season (September 21 to March 20) is the period when the sun is south of the equatorial plane. For reference, southern climatic seasons are as follows: spring (primavera), September 21 to December 20; summer (verano), December 21 to March 20; fall (ontono), March 21 to June 20; winter (invierno), June 21 to September 20.

The asymmetrical distribution of precipitation on the east and west sides of the central Andes, and the seasonality of precipitation on the Peruvian altiplano can be explained by the position of these air masses in relation to the mountains. On the coast, subsiding air from the eastern edge of the South Pacific anticyclone, and the Humboldt Current which holds moisture in a cool sea-level inversion, act together to prevent storms. These two factors are responsible for the desert-like condition of this region (Sick, 1968). More regional weather energetics and dynamics may also cause the peculiarly dry coastal weather, a view favored by Lettau (1976), who discounts the local influence of planetary winds along the Peruvian coast. In contrast, the eastern escarpment of the Andes is an area of year-round orographic rainfall. Moist air from the South Atlantic anticyclone is blown over the mainland, and cools and expands as it ascends the lower slopes of the mountains. This reduces its capacity to retain moisture, and rainfall results (Johnson, 1976). This same air, if it crosses the altiplano and moves down the western slopes of the Andes, has an opposite effect. As the air moves downslope its barometric pressure and temperature increase, and both of these factors increase its capacity to hold water. Precipitation is rare and these warm, dry winds may actually increase desiccation by evaporating moisture from plants and soil. The coastal desert then is an area of "rainshadow" with regard to the Atlantic anticyclone.

From April to September, moist winds of the South Atlantic anticyclone are deflected inland by a small low-pressure area over the Gran Chaco, but do not penetrate to the altitude of the Andean intermontane basins. During this period (which corresponds to the highland dry season) the altiplano is dominated by an easterly flow of gusty, turbulent, subsiding air from the upper atmosphere over Brazil. Consequently it receives little or no precipitation. This situation changes with southward displacement of the intertropical front (ITF, also known as the intertropical convergence zone, ITCZ) during the southern solstice season. Movement of the ITF and associated weather-front activity intensifies the spilling of cloud masses and precipitation through passes and gaps of the Cordillera Oriental and onto the altiplano (Garbell, 1947; Troll,



a.



b.

Figure 2. Generalized pattern of surface air flow and pressure areas over South America. (a) Southern solstice season (February). (b) Northern solstice season (July). ITCZ - Intertropical Convergence Zone. Dashed line - Tropic of Capricorn. (Redrawn from ONERN/CORPUNO Vol. I, 1965 and Garbell, 1947.)

1968). Precipitation in the highlands reaches a peak in January and February, when the front is in its southernmost position, and the thermal low-pressure areas of the Amazon Basin are at their greatest development (Johnson, 1976).

The position of the ITF also helps explain the reduction in annual precipitation as one moves southward from Columbia and Ecuador into Peru and Bolivia. Because of strong solar insolation in the Andes, thermal updrafts are common. If there is sufficient moisture in the rising column of air, precipitation will form. In Columbia and Ecuador, both in proximity of the ITF throughout the year, these convective storms produce precipitation year-round. Rainfall is heaviest during two seasons, March to May and October to December, which coincide with two passes of the ITF and the sun over the region. Moving south along the Andes, away from continuous influence of the ITF, less moisture is available for convective storm formation. Annual precipitation decreases and becomes concentrated into a single wet season as on the southern Peruvian altiplano. The initiation of this wet season advances from Ecuador rapidly south and gradually to the west in a series of pulses through the months of September and October, with considerable variation from year to year (Johnson, 1976). Retreat of the wet season toward the north is usually more abrupt. The Bolivian and Chilean portions of the altiplano, which are distant from the southernmost extension of the ITF, receive almost no rainfall. This area is a desert known as the Puna de Atacama.

Besides decreasing total precipitation and increased seasonality of its distribution, Johnson (1976) has noted a third factor which varies along the axis of the central Andes: variability in annual precipitation totals increases toward the southeast. Johnson points out that the coefficient of dispersion, a measure of the variation on either side of the mean which will encompass 67% of the annual rainfall observations, is 14% at Oroya, 11% at Cerro de Pasco, and 10% for Yauricocha, all central Peruvian towns. Farther south the variation increases, as evidenced by the coefficients of dispersion for Cuzco (27%), LaPaz (19%), and Oruro (28%). It is generally true that weather

variations are largest in climatic border areas, which the altiplano is with regard to ITF activity.

One major air mass remains to be discussed: the polar low off the tip of South America. Although distant from the central Andes, this region is important in the formation of weather phenomena that affect the continent far to the north. One of these phenomena important in the highlands is the friagem (Garbell, 1947). The friagem is an outbreak of cold, polar, maritime air that originates in the vicinity of the Antarctic Peninsula to the east of the polar low. This high pressure air mass moves north across South America causing intense frosts. A more complete description of a friagem will be given in the section on temperature.

Tropical latitude and high altitude are two other major factors that affect the climate of the central Andes. Their influence has been discussed by Troll (1968) who makes a distinction between "seasonal temperature climates" and "diurnal temperature climates." The altiplano is in the second category. Seasonal temperature variation is slight, as it is in other tropical regions. At the higher altitudes, however, diurnal temperature variation is significant. Intense solar radiation through a thin atmosphere produces warm afternoon temperatures. Loss of heat at night enhanced by low atmospheric density, low vapor pressure, and a general absence of clouds, reduces night temperatures to freezing or below. The range of temperature variation is reduced somewhat during the cloudy wet season, but of major importance to plant and animal life in the highlands is the fact that frosts can occur at any time during the year and are generally more likely the higher the altitude.

The major variables affecting climate of the central Andes then are the geographic massiveness and high elevation of the mountains interacting with large air masses, and secondly, latitude interacting with altitude. Decreasing precipitation gradients exist from northwest to southeast along, and from northeast to southwest across the mountains. Seasonal temperature changes are modest, but diurnal temperature variation and the frequency of frosts are significant; both increase with altitude. The altiplano of southern Peru, which

can simply be characterized as cold and dry, sits at an intersection of these gradients, just short of the extremes. It is slightly lower than the frost deserts and permanent snowfields of the higher mountains and somewhat north of the deserts of highland Bolivia.

With this background, we now turn to a discussion of the climatic elements mentioned by Eidt (1968): precipitation, temperature, wind, and cloud cover. We will also cover relative humidity, vapor pressure, and solar insolation. Topography, exposure, distance from the lakes, and other physical features become important as we examine the smaller geographical area of the altiplano.

Precipitation

The seasonal distribution of rainfall on the altiplano is evident in Figures 3a, 4a, and 5a. The rains begin in September or October, reach a peak intensity in January or February, and end in April. The remainder of the year receives little or no precipitation. Total annual precipitation averages 830 mm on the northern region of the altiplano (Figure 3a). In general, the annual cycle of plant, animal, and human activities follows this seasonal rhythm, but several kinds of variability induce deviations which are not evident in the mean figures. Droughts, which may last for periods of from one to several years and which appear without predictable regularity (ONERN/CORPUNO Vol. I, 1965), are fairly common on the altiplano. Figure 6 shows one year (1939/40) from a severe drought sequence which lasted about 3 years and had severe local economic consequences. Rainfall was reduced by 55% during 1939/40. Another kind of drought common to the altiplano does not involve a significant reduction in annual precipitation, but is based on irregular monthly distribution of rainfall. In particular, insufficient precipitation during the months critical to plant growth can produce the effects of a year-long drought. September and October, the initiation of the growing season, are especially vulnerable in this respect. The vertical lines in Figure 3a, which represent one standard deviation above and below the mean values, indicate the magnitude of this monthly irregularity.

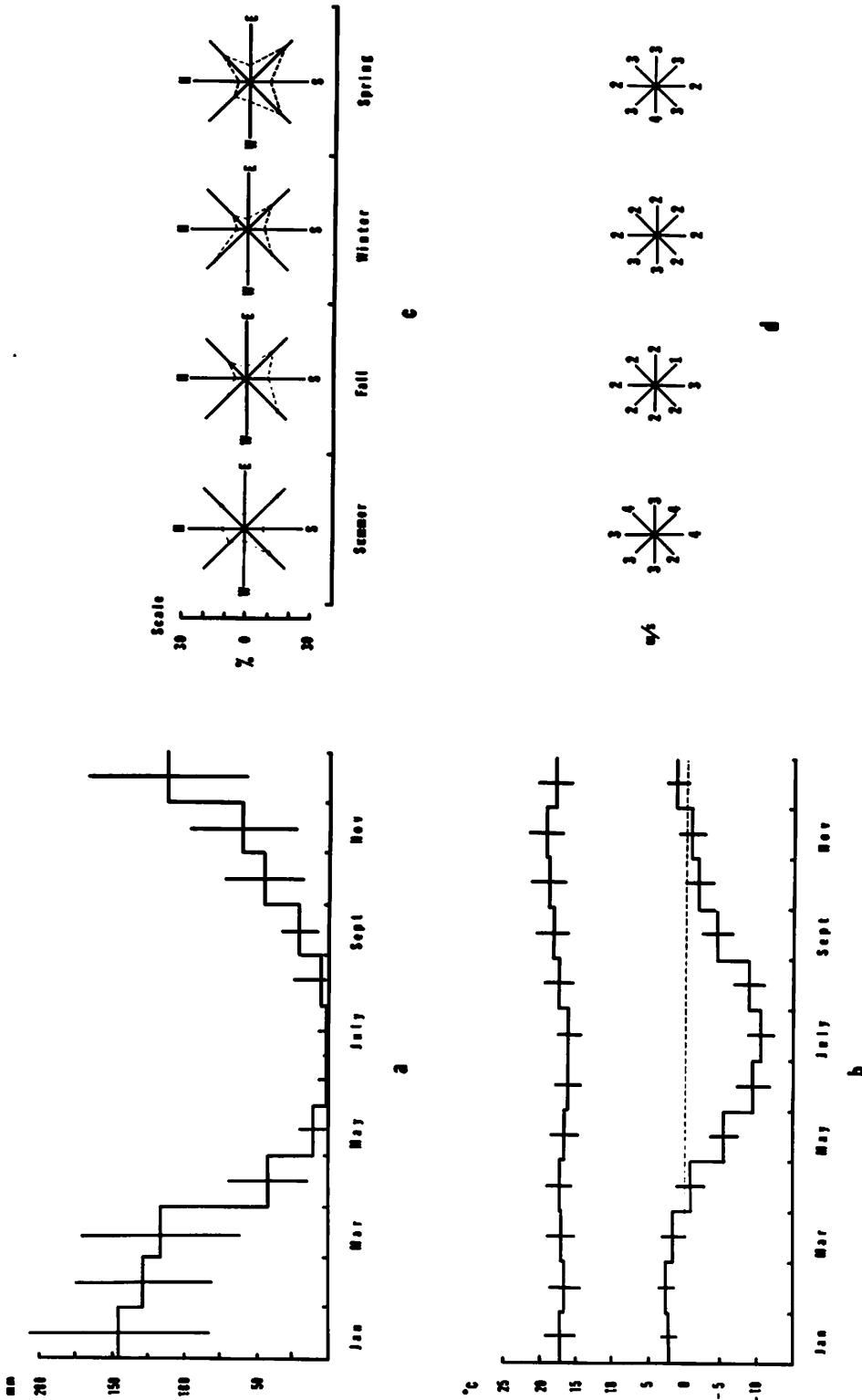


Figure 3. Climatic data for Chuquibambilla (Department of Puno, 70°43'W, 14°47'S, 3910 m), an alti-plano station located about 100 km northwest of Lake Titicaca and about 35 km southwest of Nuña. (a) Mean precipitation by month for the period 1931 to 1972. Vertical lines represent 1 standard deviation above and below mean values. Mean annual precipitation is 830.4 mm. (b) Mean maximum and minimum monthly temperatures (°C) for the period 1931 to 1972. Vertical lines represent 1 standard deviation above and below mean values. Mean annual maximum temperature 17.3°C; mean annual minimum -3.0°C; range 20.7°C. (c) The frequency of wind from a given direction in each of the four seasons. (d) The average velocity ($m s^{-1}$) of the winds depicted in (c). Both (c) and (d) are averages from 7 yr of observations. (Both a and b courtesy of Dr. Antonio Santos Aragon, Servicio Meteorologico de la Granja Modelo de Puno, Chuquibambilla; c and d from ONERN/CORPUNO, Vol. I, 1965; reproduced with permission of the Institute of Ecology from Baker and Little, 1976.)

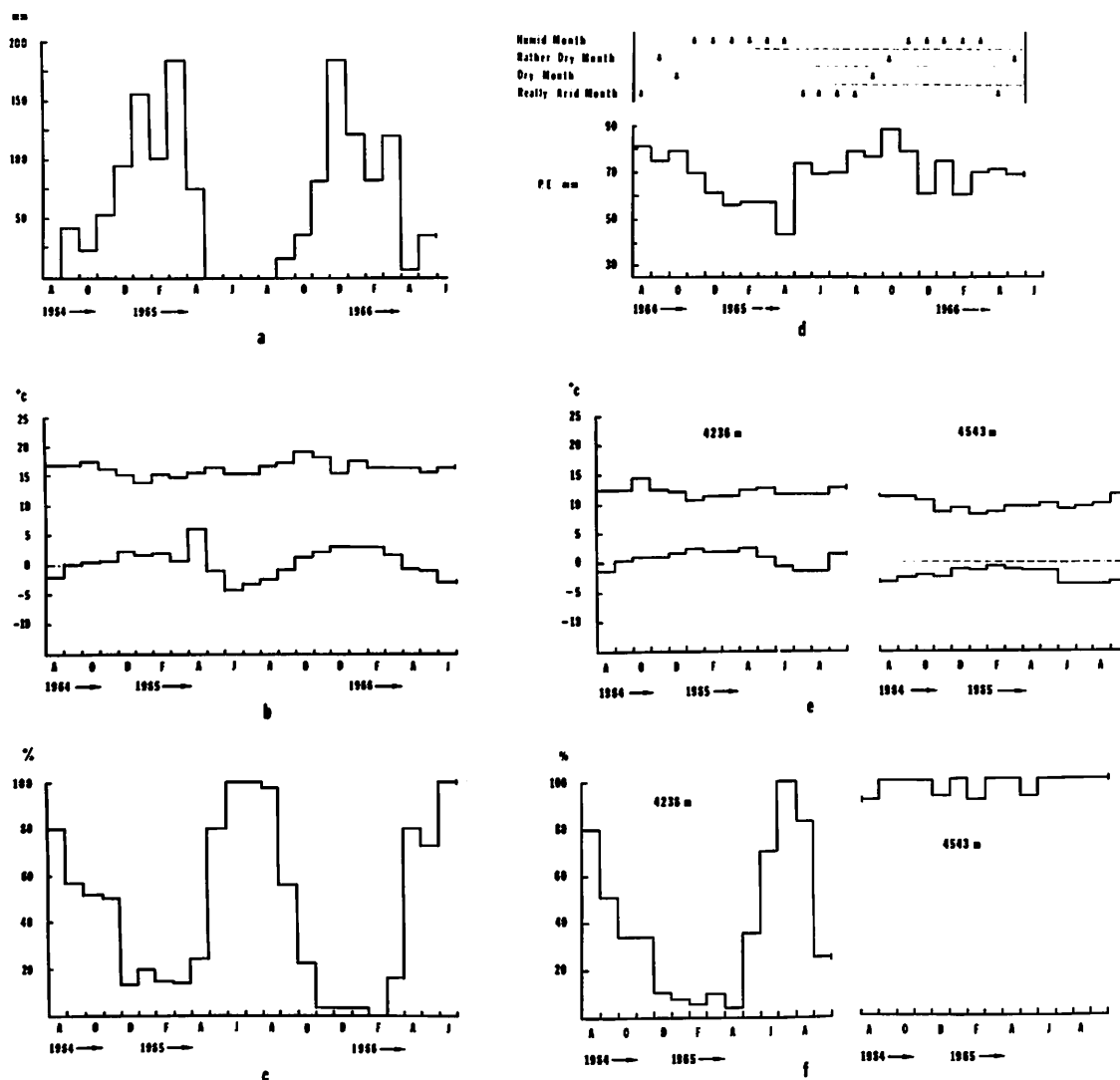


Figure 4. Weather data for the District of Nuñoa (70°38'W, 14°28'S, 3974 m) for the period April 1964 to June 1966. (a) Monthly precipitation. Average annual precipitation is 710.3 mm. (b) Mean maximum and minimum monthly temperatures. The 2-yr period maximum is 16.4°C and the mean minimum is 4.0°C. (c) The frequency of daily temperatures below 0°C in a given month. (d) Potential evaporation (P.E.) for the Nuñoa station, calculated by the method of Crowe (1971). This measure takes into account monthly precipitation, temperature, and changes of insolation by season and with latitude. The relationship between P.E. and actual rainfall (P) determines the climatic characterization given in the upper portion of the graph (humid month P.E. < P; rather dry month P.E. > P but < 3P; dry month P.E. > 3P but < 6P; really arid month P.E. > 6P). (e) Mean maximum and mean minimum temperature for Nuñoa weather stations at 4236 m and 4543 m. At 4236 m: mean maximum for the period 12.2°C; mean minimum 0.7°C; range 12.9°C. At 4543 m: mean maximum for the period 9.8°C; mean minimum -2.3°C; range 12.1°C. (f) The frequency of daily temperatures below 0°C in a given month at 4236 m and 4543 m. (Data from Baker *et al.*, 1968; reproduced with permission of the Institute of Ecology from Baker and Little, 1976.)

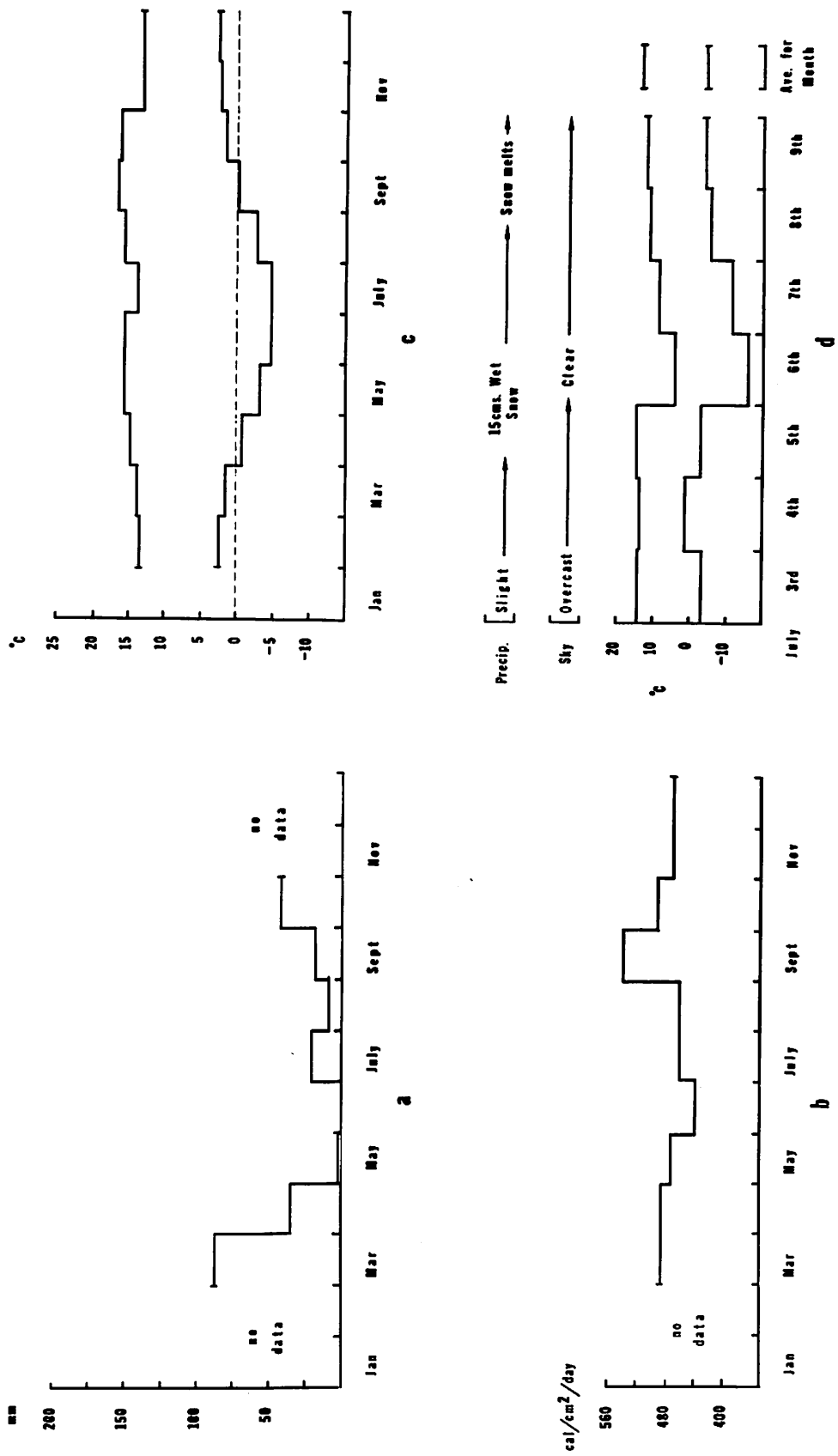
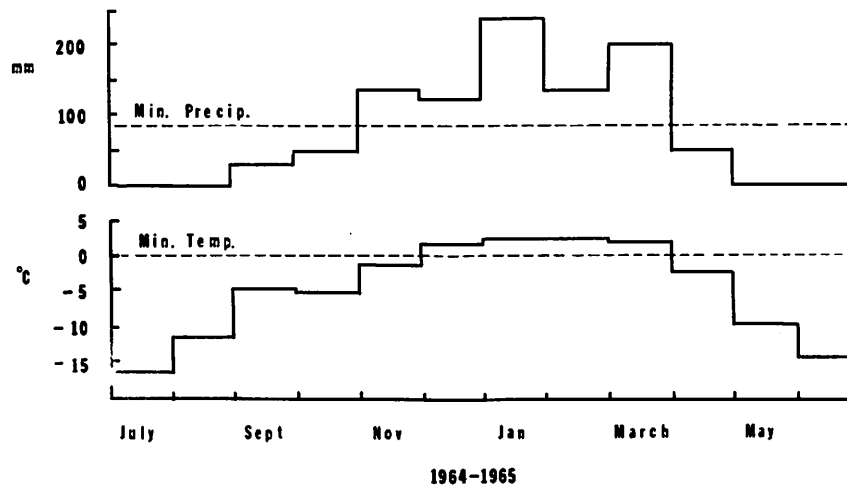
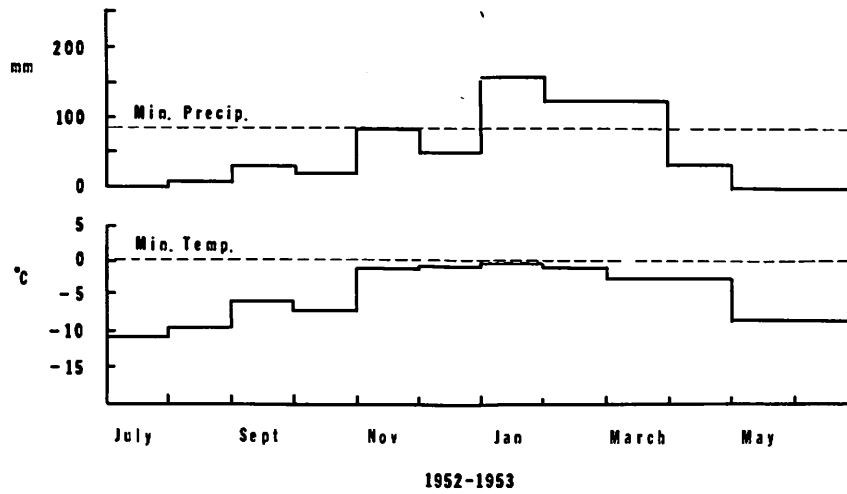
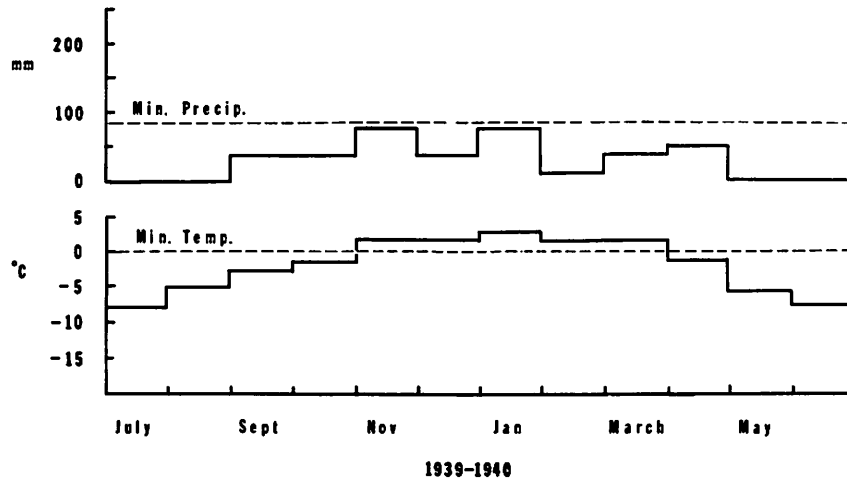


Figure 5. Weather data for the town of Nuñoa in 1968 (3974 m). (a) Precipitation. (b) Solar insolation (cal · cm⁻² · day⁻¹) measured by a Belfort pyrheliograph. Mean annual insolation for the period shown is 468 cal · cm⁻² · day⁻¹. (c) Mean maximum and mean minimum temperature for the period shown July 3, 1968, representing a dynamic frost or frigidem. Passage of the polar front (July 5 and 6) is accompanied by heavy snowfall and rapidly dropping temperatures. Unlike the normal highland pattern, ground snow persists for several days. (Data from Thomas, unpublished; reproduced with permission of the Institute of Ecology from Baker and Little, 1976.)

The rugged topography of the high-altitude land surface introduces geography as a variable in the distribution of precipitation. We have already mentioned that convective storms are important on the altiplano. This type of storm is influenced by local factors such as winds, humidity, and solar heating of the ground surface, which are in turn affected by the very uneven topography of the central Andean region. Localization of showers is particularly evident during drier portions of the year (Johnson, 1976). Orographic precipitation, caused by movement of air up mountain slopes, is directly affected by local topography. Violent thunderstorms are a common feature over the mountains of southern Peru during the southern solstice season (Schwerdtfeger, 1976a). Because of these factors, precipitation in one valley can be quite different from that of a neighboring valley, and both may vary independently from year to year or month to month (Thomas, 1973). Areas situated near gaps in the eastern Cordilleras through which humid air flows will have more precipitation than areas isolated from this source of moisture (Mann, 1968). An example of this is the region over and to the immediate east of Lake Titicaca, which has greater than normal altiplano precipitation due in part to reduced altitude of the adjacent eastern Cordillera (Schwerdtfeger, 1976b). A similar situation is evident downwind from large water bodies such as Lake Titicaca (ONERN/CORPUNO Vol. I, 1965).

Although snow and hail can fall during any month of the year, these represent a small proportion of highland precipitation. Snow is most common in the transitional months between the solstice seasons. It generally occurs at night when air and ground temperatures are cool, and rarely reaches a depth of more than several inches. Because of the diurnal temperature cycle, nighttime snowfall melts the following day, usually by mid-morning. Seasonal accumulation of snowfall below permanent snowfields, which is common in temperate latitude mountains, does not occur in tropical mountains (Troll, 1968). Hail is common in the daytime and hailstorms are frequent during the warm transitional months of the southern solstice. Hail is formed in the strong vertical updrafts of the convective storms which are typical of the wet season.



From a biological viewpoint, the amount of water available to plants and animals can be quite different from that measured at a collecting station. The capacity of the land to capture, store, and distribute water is as important as the amount of precipitation itself. Thus features of topography and soils complicate the already variegated pattern of water availability on the altiplano. Permanent snowfields and glaciers of the higher mountains provide a year-round source of water to streams and rivers. In some places these support small areas of continuously green plant associations. In other places, however, rivers have eroded below the surface of the puna and without irrigation little of their water is available to plants. Precipitation falling onto steep topography with shallow, eroded soils is subject to rapid runoff. This is especially true during heavy rainfall. Tosi (1960, quoted in Mann, 1968) states that 60% of highland precipitation becomes runoff. Many flatter landforms of the altiplano are built on deposits of alluvial and glacial debris. Here, water is likely to drain through shallow soils into the deposits and out of the reach of plant roots. Low atmospheric pressure, high insolation coupled with the daily warming cycle, and winds unimpeded by natural or artificial windbreaks encourage surface evaporation and contribute to dessication (Hodge, 1946). However, there are checks on these processes. Good soil development and a cover of vegetation can increase the water-retaining

Figure 6 (page 18). Instability of annual precipitation and temperature. Each of these graphs represents 1 year of weather data chosen from the records of Chuquibambilla (3910 m). 1939 to 1940 is a drought year (total precipitation 362.8 mm; mean minimum temperature for the year -1.7°C). In the next year depicted (1952/1953) precipitation is nearer to normal (625.6 mm) but mean monthly minimum temperatures never rise above freezing (mean minimum for the year -4.9°C). The third year, 1964/1965, is a good agriculture year with early and abundant precipitation followed by a continuously warm and wet cropping season (total precipitation 955.9 mm; mean minimum temperature for the year -4.0°C). The annual cycle is strongly developed, but monthly irregularities are slight. Minimum values for agriculture of highland crops have been established by ONERN/CORPUNO, Vol. 1 (1965) at 80 mm of precipitation per month and 0°C . (Data courtesy of Dr. Antonio Santos Aragon; reproduced with permission of the Institute of Ecology from Baker and Little, 1976.)

capacity of the land. Snow and hail can counteract runoff and drainage by the slow release of water with melting (Johnson, 1976). Thus it is the balance and interplay of numerous factors of meteorology, topography and landforms, soils and geologic substrate, and vegetation that determine how much water altiplano plants and animals actually obtain.

Temperature

Temperature is the second climatic element we will consider. Because the altiplano is located within the earth's tropical region, there is a fairly constant change of mean temperature with altitude (Eidt, 1968) and a general absence of seasonal changes in mean temperature. It is estimated that mean annual temperature for the Andes as a whole drops 0.5°C per 100 m of elevation. On the altiplano between 4000 and 4500 m, Baker *et al.* (1968) have recorded a slightly greater drop of 0.8°C per 100 m. Mean daily minimum temperature shows an annual cycle: high during the cloudy months of the southern solstice season and lower in the clear months of the northern solstice season. Mean daily maximum temperature is nearly constant throughout the year (Figure 3b). During the southern solstice season, elevated minimum (nighttime) temperatures result from increased net positive radiation associated with increased day length. Elevated vapor pressure, greater soil moisture, and greater incidence of cloud cover during this same season compliment the trend by inhibiting the radiation of terrestrial heat into space during the night. Maximum (daytime) temperatures remain fairly constant during the southern solstice season because (1) insolation is less affected by atmospheric humidity, and (2) incoming extraterrestrial radiation during this season is reduced by the greater cloudiness (Prohaska, 1970). During the northern solstice season, in contrast, long clear nights produce the low minimum temperatures. Reduced day length, and a reduced angle of solar insolation is compensated for by greater daily amounts of sunshine through clear skies, so that daytime maximum temperatures are relatively unaffected by the seasonal change in the sun's position (Johnson, 1976). The shortness of the vertical lines in Figure 3b, which represent one

standard deviation above and below the mean, are indicative of the stability of the daily maximum-minimum rhythm.

Other aspects of highland temperature are apparent from Figures 3b and 4b. First, this area has what Troll (1968) calls a "diurnal temperature climate," meaning that major temperature changes occur in a daily cycle. Strong insolation during the day produces a peak afternoon temperature of about 17°C. Rapid loss of this heat through a thin atmosphere, especially on clear nights, reduces night temperatures to near freezing or below. The mean range between maximum and minimum temperatures is over 20°C. Second, with minimum temperatures near or below freezing throughout the year, night frosts can occur in any season (see Figure 4c). The frequency of night frost is a major factor influencing the vertical distribution of vegetation in the Andes (Troll, 1968; Figure 7). Because of the importance of minimum temperatures in this environment we will discuss frosts in some detail.

Two types of frost occur on the altiplano. First, and most frequent, is the static frost caused by a rapid loss of lower air and ground heat at night. Topography is an important dimension of the static frost. Cold air drains downslope into basins and valleys causing stable inversions of freezing air near the ground. The cold air layer may be only 100 to 300 m thick (ONERUN/CORFONO Vol. I, 1965). This point is illustrated in Figures 4c and 4f which compare the frequency of daily temperatures below 0°C on the valley floor (3974 m), the lower slopes (4236 m), and the higher slopes (4543 m). While freezing temperatures occur almost nightly on the upper slopes, it is the lower slopes and not the valley floor which have the fewest frosts. Static frosts are usually a few degrees below zero, and last for several hours during the night. Eighty percent of all highland frosts are of this type, 70% occurring during the northern solstice season, and 10% during the southern solstice season. The local name for these frosts is heladas blancas. The second type of frost is the dynamic frost, and as the common name heladas negras suggests, it is the more severe of the two. The dynamic frost is caused by a northern eruption of a polar cold front followed by cold, maritime, polar air. The air mass moves over Argentina, between the Andes and Brazilian uplands,

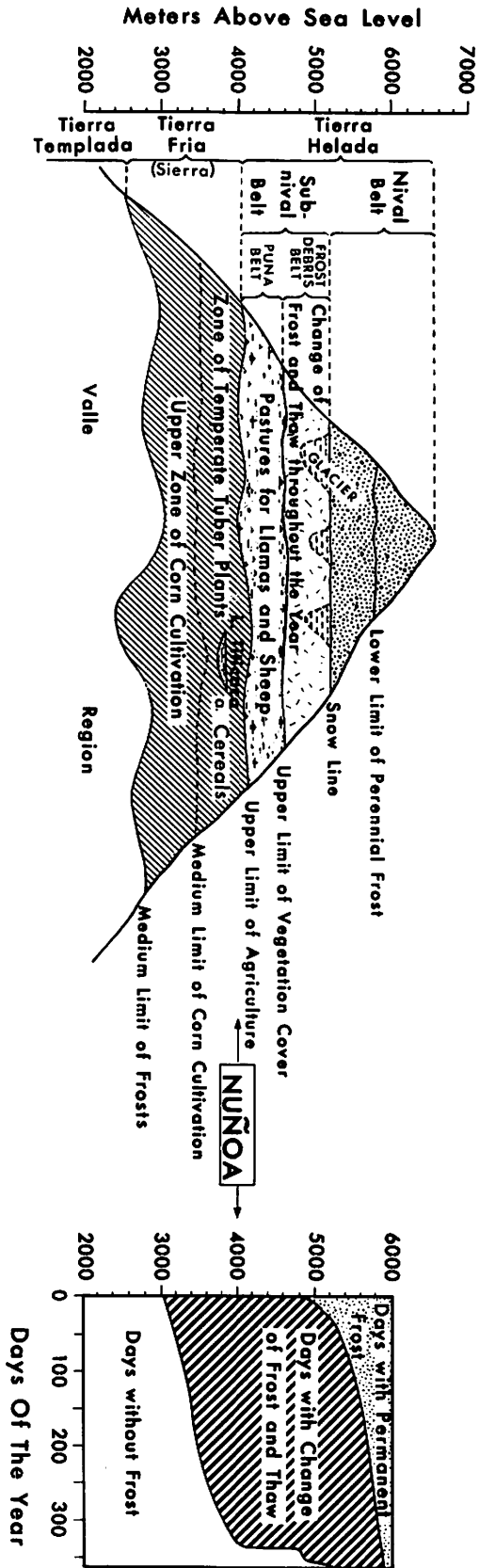


Figure 7. Vertical zonation of agricultural vegetation types and frost climates in the Andes of southern Peru. The zonation of frost climates is based on information from Mt. El Misti in southern Peru. (Modified from Troll, 1968; reproduced with permission of the Institute of Ecology from Baker and Little, 1976.)

and occasionally onto the altiplano. Garbell (1947) uses the term friagem for this phenomenon, and describes the sequence of events as follows: squalls and thunderstorms which accompany passage of the front are followed by overcast skies, a southern wind, and a rapid drop in temperature. The cold air mass which follows the front and causes subfreezing temperatures may last for several days before breaking up. The first clear night after passage of the front is likely to be the coldest (Figure 5d). ONERN/CORPUNO Vol. I, (1965) reports that 20% of all altiplano frosts are of this variety, 18% during the northern solstice season, and 2% during the southern solstice season. The majority (88%) of both types of frost occur during the northern solstice season. However, an occasional frost or dry spell associated with unstable air masses during the transitional spring season is sufficient to cause widespread damage to young plants. Thus instability of the transitional seasons is a critical factor for vegetation development in the highlands (Schwabe, 1968). Frosts, rather than the low mean annual temperatures themselves, are critical for highland plant communities (Mann, 1968). Because wet soils have a greater heat retaining capacity, frosts are more likely to occur when soils are dry.

We should comment on three other aspects of highland temperatures. First, the altiplano is not a "heat-deficient habitat" in the sense of Darlington (1965). The mean annual temperature of 8°C is equivalent to that of central New York. Rather, it is the strong daily cycle of temperature variation, the nightly interruption of physiological processes of plants, the similar interruption of animal activities, and the rapidity of temperature changes that are significant. Second, changes in temperature of biota, soil, or rock due to solar heating, or radiation loss of heat, may be more rapid and stronger than changes in air temperature (Koford, 1957). This is due to the large net radiation gradient between areas of insolation (intense heating) and areas of shadow (intense heat loss). Such a radiation gradient also exists between the sunlit and shaded sides of a single organism (Prohaska, 1970). Finally because dampness or high humidity can

increase the rate at which heat is lost from an organism, and decrease the insulative power of clothing, fur, or feathers, a wet day may be physiologically "colder" than a dry day with somewhat lower temperatures. Thus, the relatively "warm" wet season on the altiplano may actually be a period of greater cold stress to animals and plants than the somewhat colder dry season. Wind also enhances heat loss from organisms (the wind chill factor), although Prohaska (1970) has noted that temperature and wind speed tend to vary inversely on the altiplano, somewhat compensating their combined cooling power. Insolation, moisture, and wind can vary more or less independently over short distances and time periods creating a complex of locally variable and rapidly changing bioclimatic conditions.

Other Climatic Elements

Wind, relative humidity, cloud cover, and solar insolation are additional factors which can be discussed briefly. Uneven heating of rugged topography and associated movements of air are the most frequent causes of wind on the altiplano of southern Peru. Upslope breezes during the morning, downslope breezes during the evening, and turbulence associated with convective currents are common. These winds are variable in intensity and direction (Figure 3c and 3d), and are seldom of sufficient strength to cause damage (ONERN/CORPUNO Vol. I, 1965). In areas near Lake Titicaca, up- and downslope breezes are replaced by on- and offshore breezes. Relative humidity follows a diurnal pattern opposite to that of temperature. Limited data (Thomas, unpublished; Larsen, 1973) suggest nighttime values of 40% to 60% with values of less than 10% for most of the daytime period during the dry season. Cloud cover and insolation are inversely related, and the fairly constant insolation values we have for Nuñoa (Figure 5b) indicate an absence of seasonal full-day overcast. Clear skies predominate during the northern solstice season, and during the southern solstice season a pattern of clear mornings with increasing cloudiness and formation of convective storms through the afternoon is common. Insolation varies with exposure, and is greatest on north- or west-facing slopes.

Finally, atmospheric pressure and the partial pressure of constituent gases, absolute humidity, and background radiation are all associated with altitude. At a representative altiplano altitude (4000 m), the barometric pressure averages 463 mm Hg, the partial pressure of oxygen is 97 mm Hg, and the partial pressure of carbon dioxide is 0.14 mm Hg, a reduction in all three measurements of about 40% compared to sea level values. Sea level values are, respectively, 760 mm Hg, 159 mm Hg, and 0.23 mm Hg. As can be seen in Figures 8a, 8b, and 8c, barometric pressure and the partial pressures of oxygen and carbon dioxide change fairly regularly with altitude. However, these values also vary in ways not directly altitude-related (Prohaska, 1970). High water vapor density, associated with the rainy season (southern solstice season) reduces overall air density, and consequently reduces the amount of oxygen and carbon dioxide. Irregular middle troposphere pressure changes can also affect the partial pressure of oxygen and carbon dioxide, by amounts equivalent to an altitude change of several hundred meters. Finally, there is the regular and twice daily variation in tropical air pressure, equivalent to a change of somewhat more than 50 m in altitude.

Absolute humidity, which measures the drying power of the air or the physiological saturation deficit, decreases exponentially with increasing altitude, but also exhibits considerable seasonal variation. Thus, at the altiplano station of Salcedo (15°59'S) the mean value is 4.0 g m^{-3} , and the annual range of monthly means is 2.6 to 5.2 g m^{-3} ; at Imata, another altiplano station (15°49'S), the mean value is 2.8 g m^{-3} and the annual range of monthly means is 1.8 to 4.2 g m^{-3} (values from Prohaska, 1970, Fig. 1). Stations on the eastern side of the Andes have higher absolute humidities than those on the drier western side at similar altitudes. In general, absolute humidity on the altiplano is more a function of season, and position of the measuring station on major precipitation gradients, than it is of strict altitude (Prohaska, 1970).

Background (gamma) radiation is primarily of two sources: cosmic and terrestrial. Cosmic radiation increases with altitude as shown in

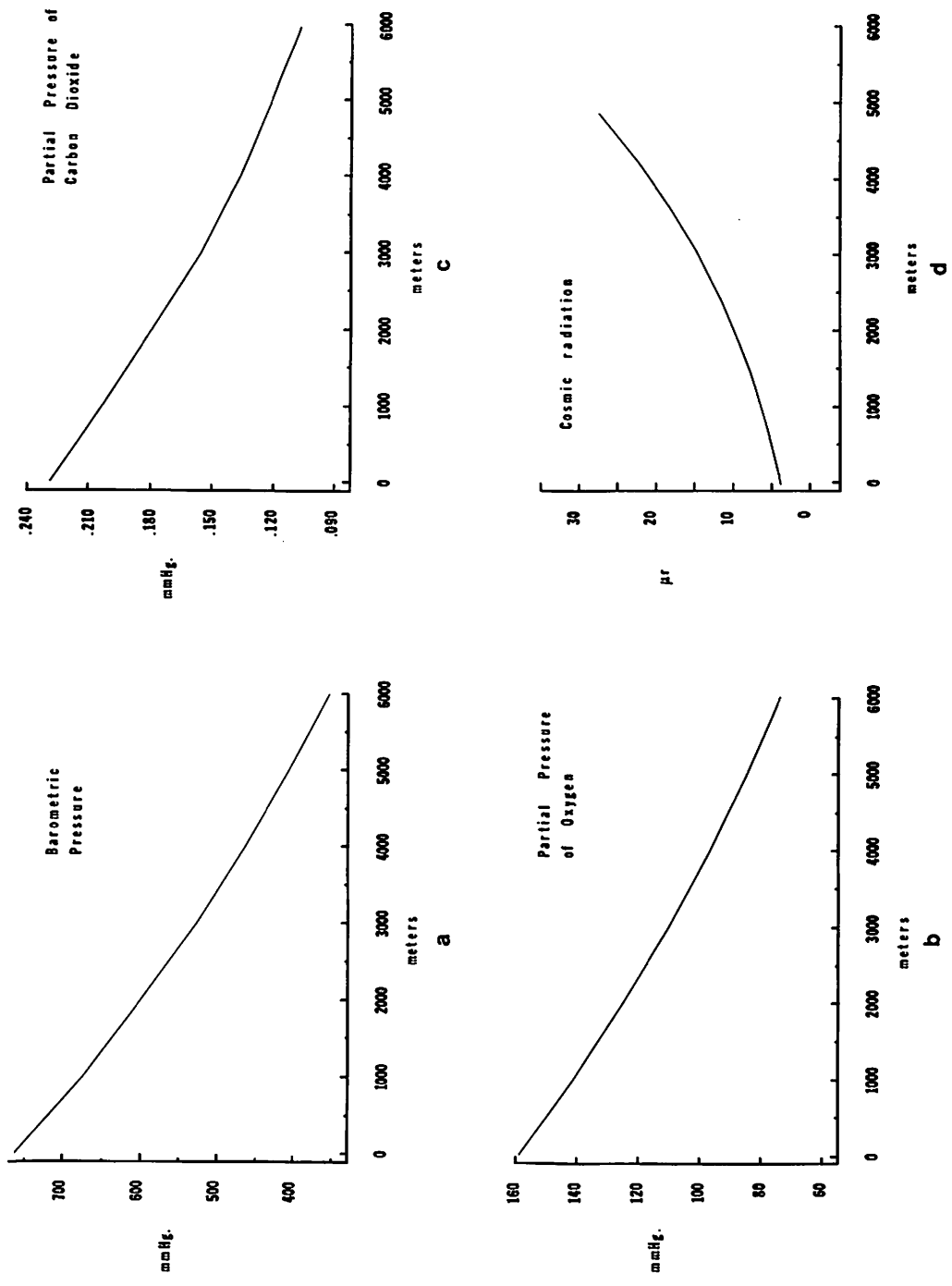


Figure 8. Reduction in barometric pressure (a), in partial pressure of oxygen (b), and partial pressure of carbon dioxide (c) with increasing altitude, and increase of ionizing cosmic radiation with altitude (d). (Data for a, b, and c from Consolazio et al., 1963; d from Solon et al., 1960; reproduced with permission of the Institute of Ecology from Baker and Little, 1976.)

Figure 8d. Cruz-Coke *et al.* (1967) estimate cosmic radiation on the altiplano of northern Chile at $22 \mu\text{r hr}^{-1}$, a value close to that given by Solon *et al.* (1960) for altitudes of 4000 m (see Figure 8d). Terrestrial radiation depends on the exposure of different kinds of crustal material, but is generally greater in mountains, and greater near granitic rock (Hultquist, 1956; Grahn and Kratchman, 1963). We have not measured terrestrial radiation on the altiplano, but it should be high in the geologically young Andes Mountains, and should be highly variable depending on the presence and exposure of granitic outcrops.

In summarizing this description of the highland climate, two points which require emphasis are scale and importance of environmental pattern. For each climatic element, particularly for precipitation and temperature, we have discussed a general pattern and reviewed sources of variability which cause regular and non-regular fluctuations. The sources of variability include sharp gradients of altitude and topography, and meteorological changes which occur daily, monthly, or annually. When these various elements are superimposed and interacting, a finely scaled mosaic of climatic conditions emerges. One valley has different weather from the next, and valley floor is different from the slopes of the surrounding hills. On a single hillside, the banks of a small stream or shelter of a rock outcrop offer unique microclimates. These all change over time. Dozens of other similar small-scale situations could be described but the important point is that marginal availability of moisture and of protection from frost make these small changes critical to plants and animals, and to human horticulturalists and herders.

SOILS

Papadakis (1969) divides the soils of the southern Peruvian altiplano into two extensive subgroups: the recent brown soils and the chernozemic brown (Prairie) soils. The recent brown subgroup is made up of raw (undifferentiated) soils with a low degree of leaching. These soils are composed of unmodified or little-modified parent material such as recent alluvium or consolidated rock. They are often classified on the basis of this source material. All horizons of the recent brown soils are neutral pH and the upper limit of effervescence is below the surface. The corresponding classification in the (US) Soil Taxonomy (Soil Survey Staff, 1975) is entisol. Chernozemic soils, also characterized by a low degree of leaching and neutral horizons, have a dark humic layer at least 25 cm thick, formed under the influence of grassland cover. Chernozems usually originate on calcareous or volcanic materials, or glacial drift. The altiplano group of chernozem soils, the chernozemic brown (Prairie) soils, lack a textural B horizon. The designation for a chernozem in the Soil Taxonomy (Soil Survey Staff, 1975) is mollisol. The mineral fertility of both subgroups is usually good; parent materials are geologically young and have not undergone intense leaching.

Within the regional subgroups given by Papadakis (1969) is a variety of local soils reflecting the process of soil genesis in high mountains. The complex mosaic stratigraphic and volcanic rock types exposed in the Andes are the parent materials which dominate the raw highland soils and which underly the pattern of soil distribution. Local soils are undeveloped (raw) for a number of reasons. Mechanical weathering (flake-weathering) is intense in the diurnal highland climate (Schwabe, 1968), but cold and dryness that inhibit chemical weathering and decomposition of organic matter (Weberbauer, 1936; Cabrera, 1968) can slow the evolution of soils. Solifluction, the downslope movement of surface material with the freeze-thaw cycle, is another climatic factor impeding soil development (Troll, 1968). Strong erosion, sedi-

mentation, glacial scouring and deposition of outwash, seismic disturbance, and volcanic activity have all acted to inhibit genesis of soils in the highlands (Beek and Bramao, 1968). All of these processes are part of the young and unstable Andean landscape. In contrast, plants enhance weathering, prevent erosion, and contribute organic material to upper layers of the soil. The chernozems mentioned in the previous paragraph are an example of this latter process.

Local mapping of soils is difficult because of the complexity of soil type distribution. This is evident in Figure 9 which shows the variety of soils that can be found in a small area of the altiplano. Figure 10 is a map of the geological substrate underlying the soils.

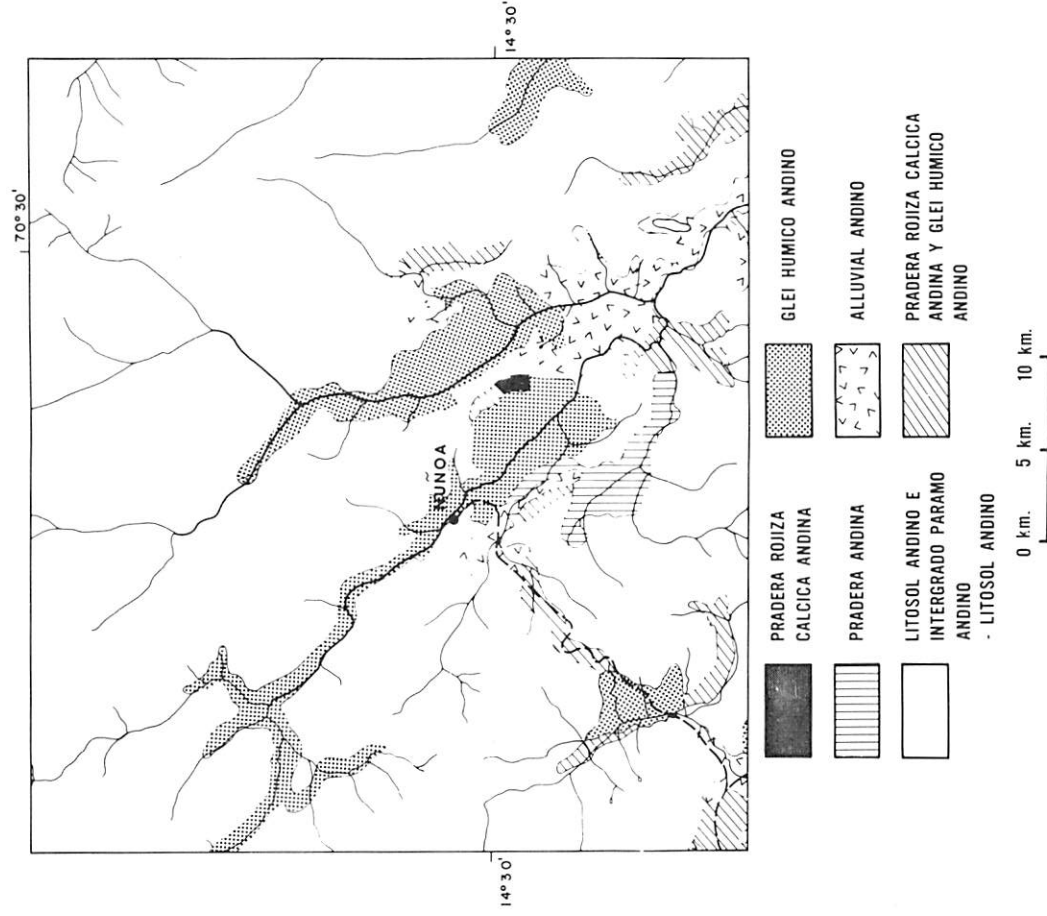


Figure 9. Great soil groups (FAO system) of the Nuñoa area. Pradera Rojiza Calcica Andina: red calcareous meadow soils with good drainage, richest in clays in the upper layers, alkaline above the textural B horizon. Pradera Andina: dark yellowish, gray-brown meadow soils leached above the textural B horizon; moderately good drainage and well-developed profile with mature evolution. Litosol Andino e Intergrado Paramo Andino-Litosol Andino: lithosols and intergrade Paramo-lithosols with no clear morphology or definition, consisting generally of imperfectly weathered materials and confined for the most part to broken and mountainous areas. Gleji Humico Andino: humic glei (Wiesenboden), upper horizons gray-black, gray-brown, or dark gray-brown, with a high organic matter content; occurring principally in flat areas or depressions where there is a normal accumulation of water, poor drainage, and partially decomposed detritus. Alluvial Andino: alluvial soils derived from materials transported and deposited recently; good drainage on gentle or flat relief. Pradera Rojiza Calcica Andina y Gleji Humico Andino: a mixed soil group. (Redrawn from ONERN/CORPUNO, Vol. III, 1965; reproduced with permission of the Institute of Ecology from Baker and Little, 1976.)

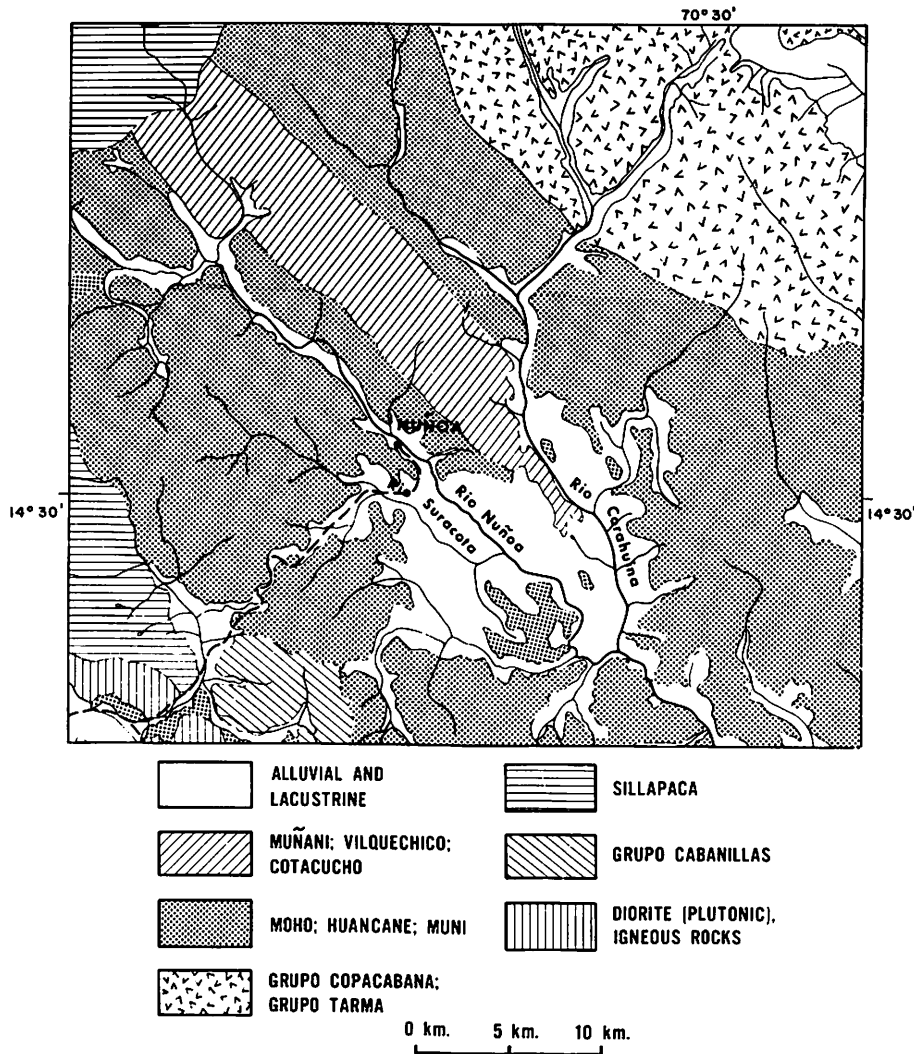


Figure 10. Geology of the Nuñoa area. Alluvial and lacustrine: clay, sand, gravel and scattered fragments of ore, transported material without consolidation; Cenozoic, Quaternary; 0 to 2% slope. Muñani, Vilquechico, Cotacucho: sandstones, claystones, conglomerates, and red gypsum; Mesozoic, Upper Cretaceous; slope > 25%. Moho, Huancane, Muni: limestones, claystones and sandstones; Mesozoic, Middle Cretaceous; slope > 25%. Copacabana, Tarma: black and gray bituminous slate, gray and blue-gray, dolomitic limestones, sandstones, slate and quartzite; Paleozoic, Lower Permian; slope > 25%. Sillapaca: outflows of basalts and andesites; calcareous tufa and agglomerate; Cenozoic, Quaternary; slope > 25%. Cabanillas: dark claystones with ferrous nodules, fossiliferous slates with strong intercalcation of quartzite and sandstone and abundant surface mica; Paleozoic, Middle and Lower Devonian; slope > 25%. Diorite (plutonic), igneous rocks: granular texture of intermediate composition; Cretaceous; slope < 10%. (Reproduced with permission of the Institute of Ecology from Baker and Little, 1976.)

ENVIRONMENTAL STRESS AND ADAPTATION

One way of organizing our perception of the altiplano environment is to consider its influence on plants and animals. Specifically, we can delineate those conditions in the highlands to which any population of the biotic community must make some kind of adjustment in order to function and reproduce effectively. In biological terms we speak of environmental stressors which are identified by the strain which they can produce in organisms, and of adaptations, or the variety of genetic and nongenetic responses that plants and animals have to mitigate the strain or modify the stress. In the following list we have grouped potential environmental stressors of the southern Peruvian highland environment into five categories:

- (1). Reduced partial pressure of oxygen and carbon dioxide, low absolute vapor pressure; high background radiation.
- (2). Rugged topography and poorly developed soils; marginal availability of certain nutrients.
- (3). Low temperatures with pronounced diurnal variation; frequent and intense frosts which can occur in any season.
- (4). A lengthy dry season and irregular monthly distribution of precipitation; droughts which may last several years and are unpredictable.
- (5). A biotic community with limited productivity spread over wide regions.

Different characteristics of a stress such as its frequency, intensity, duration, and regularity will influence the degree and kind of adaptation made. The first three are self-explanatory; regularity means that the stress varies by a predictable and repeated pattern. The lowered partial pressure of oxygen and carbon dioxide and the low barometric pressure are examples of stresses which are fairly constant (regular and of indefinite duration) and which vary in intensity

uniformly with altitude. Topography and soils change over decades or longer and have their major variability in space. Their intensity, frequency, duration (extent), and regularity can be judged from maps such as Figures 9-16. Variability in space can be thought of as patchiness. Climatic stressors can be characterized by the seasonal or daily rhythms of moderate intensity, and by the sporadic and intense instances of the stress which are generally irregular. The interruption of diurnal temperature variation by a friagem is an example of the distinction between a frequent, moderate, and regular stress of short duration, and an infrequent, intense, and irregular stress which can last several days.

Finally, all of the above physical stressors exert an influence on the spatial and temporal productivity of the biotic community and on the flow of energy and materials between populations. While the lengthy dry season, soil conditions, and diurnal temperature variations impose fairly constant limits on biota, it is the irregular stressors such as friagems and droughts which are primarily responsible for fluctuations in productivity from year to year. Organisms face a variety of stressors and stress characteristics, and their response is a complex interplay between various kinds of adaptations. Plants and animals must be capable of surviving the infrequent and rigorous environmental conditions as well as the more common ones. The following sections on flora and fauna indicate some of the general adaptations made by altiplano biota.

FLORA

The finely structured climatic and topographic variability of the high altitude Andean habitat, the dynamic processes which have produced similar variability in soils, and the turbulent history of this environment have, of course, affected its flora and fauna. Schwabe (1968:118) has stated this as follows:

Since a recent ecosystem is always the result of local developments of the biosphere and this is historically molded, an area in which orogenesis is still active cannot be considered a static substratum but rather a dynamic system whose ecological and geophysical fluctuations will play a basic role in molding the ecosystem there. The Andean region of South America, stretching as it does over 70 degrees of latitude and being very strongly determined by the aforementioned geophysical processes, is one of the most uniquely varied ecological structures of the earth occupying a continuous substratum The Andean-Pacific area is thus characterized by an unusually small-scale mosaic, which leads to sharp individualization of its landscape types.

Mann (1968) points out that climax vegetation can be found only on relatively flat ground such as areas of the altiplano or relic peneplains, and that this leaves a preponderance of pre- and post-climax vegetations on the larger areas of steeper slope. The fluctuations of habitat induced by Pleistocene glacial episodes have added to this diversity (Vuilleumier, 1971). Competitive exclusion between plant species can sharpen divisions of vegetation along altitudinal gradients, divisions already influenced by climate

and soils (Beals, 1969). All of these factors interact to produce plant distributions discussed in the following paragraphs.

Vegetation zones of the central Andes closely follow the gradients of temperature and moisture described under climate. Based on the descriptions of Troll (1968) and Weberbauer (1936), we will discuss the changes in vegetation from northeast to southwest across the Andes of southern Peru, and northwest to southeast along the central Andes. Our purpose is to place into context the more complete description of altiplano flora which follows.

The gradient northeast to southwest across the Andes has two climatic dimensions; (1) temperatures become increasingly cool and diurnal and frosts more frequent as one ascends the Andean escarpment, and (2) the high orographic moisture of the lower eastern slopes of the Andes progressively diminishes towards the southwest.

The Eastern Escarpment

East of the altiplano and approximately 4000 m below the snow-covered peaks of the Cordillera Oriental lie the tropical forest and small areas of tropical savanna (Figures 11 and 12). Favorable climate, long geological stability, and periodic expansion and contraction of the forest zone have made the Amazon Basin an area of extraordinary biotic diversity and high biotic maturity (Fittkau, 1968; Schwabe, 1968). Despite its physiographic homogeneity, the tropical forest is composed of a variety of plant associations (Weberbauer, 1936; Mann, 1968) that extend up the eastern slopes of the Andes to about 1000 m. Here the tierra caliente is replaced by the tierra templada, or zone of the lower montane tropical-evergreen forests, the yungas. Regular frosts begin at about 2500 m in the tierra fría (see Figure 7). This is an area of cloud forests, the upper montane tropical-evergreen forest, extending to about 3500 m.

Weberbauer (1936) groups the upper and lower tropical-evergreen forests under the name ceja de la montana (eyebrow of the forest) and describes this zone as being constantly veiled in fog. The fog raises humidity, moderates light, and equalizes the cool temperatures.

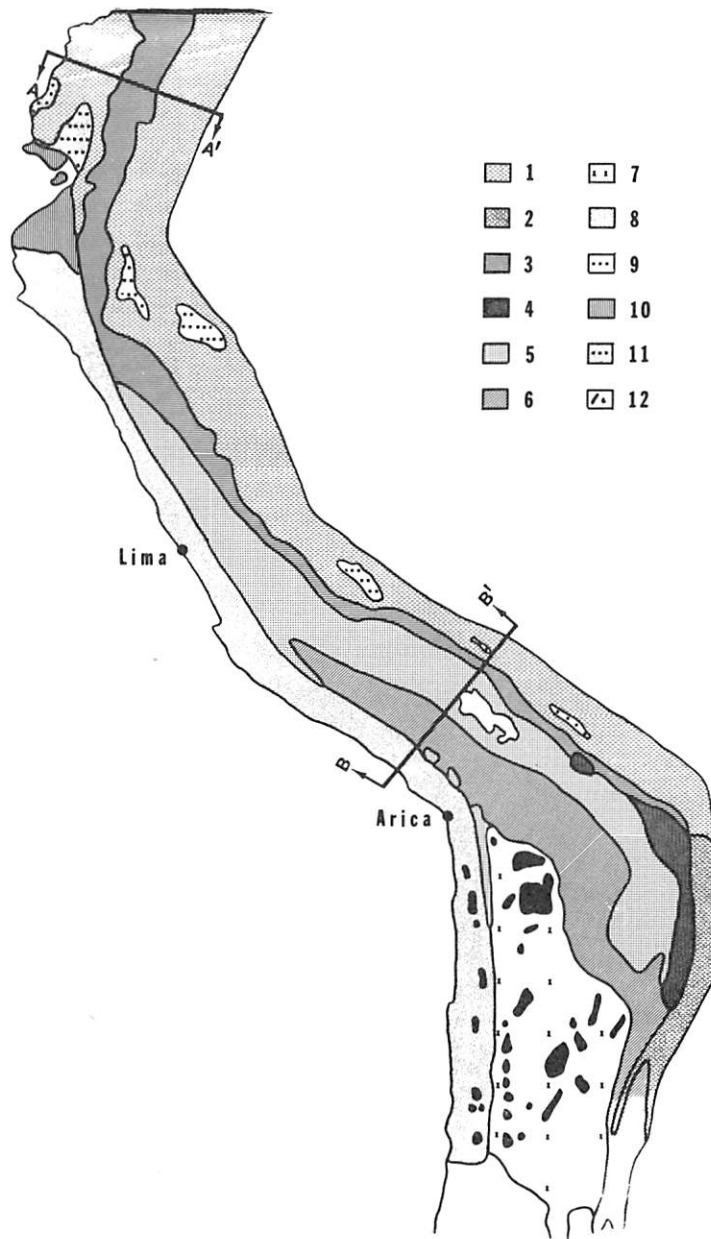


Figure 11. Vegetation zones of the central Andes. (1) tropical rain forest (including montane forests); (2) tropical-subtropical semi-deciduous forests (Tucumano-Bolivian forests); (3) equatorial paramo-belt and tropical semi-evergreen high-mountain grassland (pajonales); (4) subtropical mountain meadows; (5) moist puna belt; (6) dry puna belt; (7) thorn and desert puna (Puna de Atacama); (8) Atacama Desert; (9) open savannas within the rain forests; (10) thorn savannas (forests and grassland) in the Peruvian and Ecuadorian coastal regions; (11) moist savannas (deciduous forests and grassland) in the coastal region of Ecuador; (12) salt pans. The two double-ended arrows show the position of the cross sections of Figure 12. (Modified from Troll, 1968; reproduced with permission of the Institute of Ecology from Baker and Little, 1976.)

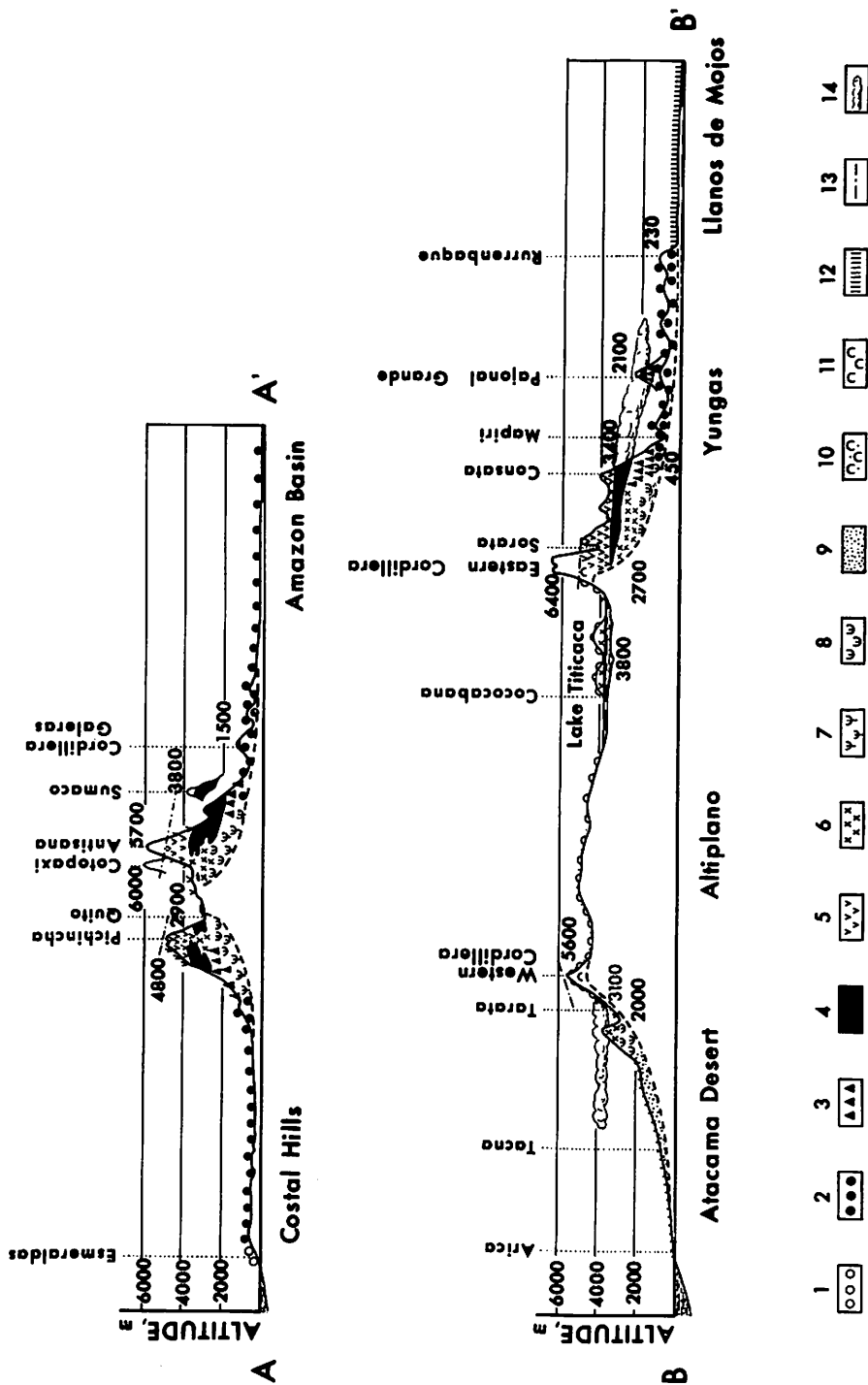


Figure 12. Cross section of the equatorial Andes of Ecuador (above) and of the tropical Andes at the latitude of Lake Titicaca, from Figure 11. (1) Semi-deciduous lowland forest; (2) ombrophilous lowland forest; (3) tropical-evergreen lower montane forest (*tierra templada*); (4) tropical-evergreen upper montane forest (cloud forest, *ceja de la montana*); (5) paramos; (6) mesophytic sierra shrub and *Polylepis* woodland (*quenuales*) of the *tierra fria*; (7) thorn and succulent woodland and shrub of the *tierra templada* (valley formation); (8) thorn and succulent shrub of the *tierra fria* (*sierra belt*); (9) desert; (10) moist or grass puna; (11) dry and thorn puna; (12) moist lowland savannas; (13) snowline; (14) cloud belt. (Redrawn from Troll, 1968; reproduced with permission of the Institute of Ecology from Baker and Little, 1976.)

Although the palms of the eastern escarpment do not extend into the ceja zone, it is characterized by an abundance of tree ferns, epiphytic ferns, lichens, mosses, flowering plants, evergreen bushwood and shrub-wood forests, and small trees. The twisted, crowded branches of the woody formations sometimes form dense mats. At higher elevations of the ceja trees become shorter and are replaced by a scrub formation with pockets of small moors and grass steppes. This scrub formation marks the transition to the tierra helada at 4000 m. The tierra helada is the area of a "microthermal grass steppe" (Weberbauer, 1936), also called the paramos. Although the paramos is a typical highland plant formation in northern Peru and Ecuador, in southern Peru it is confined to the wetter, eastern side of the Cordillera Oriental. This steppe thins out and a frost desert forms between 4500 and 4900 m; permanent snowfields begin between 4900 and 5300 m.

Concerning escarpment productivity, Ellenberg (1964) has pointed out that tropical and subtropical mountain areas that are continuously humid have their greatest vegetational productivity in the lowlands, and that productivity decreases with progressively higher altitudes. On the other hand, in topographically similar regions with a pronounced seasonal dry period, optimal plant productivity is found at the intermediate altitude cloud belt or just below--the zone where the dry season has the least effect. The central Peruvian Andes are a prime example of this. The continuously wet eastern escarpment has a high productivity in the lowland tropical rain forest, a productivity which decreases with altitude. The western slopes, however, have their highest productivity in the semi-evergreen, intermediate-altitude shrub zone, a zone associated with condensation cloudiness. Based on this observation, it should generally be true that the relative altitude of the zone of greatest vegetational productivity will increase as one moves NW to SE down the southern Peruvian Andes on either escarpment, due to the increasing development of the seasonal dry period in the same direction.

The easternmost zone of the altiplano is the moist, or grass puna; the western portion is the dry puna, a zone which Weberbauer (1936) calls the "tola heath." The vegetation of these two zones will be discussed fully in a following section.

The Western Escarpment

West of the altiplano the dry puna is the predominate vegetation zone of the Cordillera Occidental above 4000 m. Below this are formations of mesophytic shrubs. Stiff perennial bunch grasses and the tola shrub (Lepidophyllum quadrangulare) are common elements down to 3500 m. As one descends further, vegetation becomes more open and xerophytic, trees are rare, and grasses disappear. A zone of thorn and succulent shrubs and cacti with a few annual herbs and tuberous plants reaches as far as the coastal desert which begins at 2000 m. The desert, a zone without vegetation except where broken by narrow river valleys, lies below the scant precipitation of the higher mountains, and above the fogs of the coast. The last vegetation zone discussed on the northeast to southwest gradient, the lomas, depends on these northern solstice season fogs (garuas) for moisture. The lomas are a loose mat of low herbs in the coastal hills; very few grasses or woody plants are found in this zone. The lomas appear with the dense fogs and disappear in the summer solstice season when the fogs break up.

The Altiplano

The three major vegetation zones of the altiplano are the moist, dry, and the desert puna (Cabrera, 1968; Mann, 1968; Troll, 1968). These zones are long and narrow, reflecting both the topography of the mountains and the bands of decreasing precipitation which run from northeast to southwest, each one more distant from the ITF (Figure 11). Because the mountains become broader in southern Peru, the paramos and moist and dry puna zones are deflected eastward and tend to cross the Andes diagonally (Troll, 1968). In Ecuador, which receives rainfall on both sides of the relatively narrow mountains, the distribution of vegetation is nearly symmetrical (Figure 12a). As one moves southeast, precipitation decreases and becomes concentrated in a single season and the diurnal temperature range increases. The paramos are replaced by the moist puna and then the dry puna along a transect down the interior of the mountains. Where the Andes bend south, away from

the low pressure area over Brazil and the ITCZ, the interior basins become drier. This is the desert puna of Bolivia and northern Chile (Puna de Atacama), an area where salt pans and borateros are frequent.

Our description of altiplano vegetation centers on the moist puna zone outside of the influence of Lake Titicaca, and on the dry puna zone to the west, and is limited to southern Peru. The moist, or wet puna is floristically more related to the western Cordilleras than to the eastern range (Weberbauer, 1936) and the moist and dry zones share many elements. Climatic data for both Nuñoa and Chuqui-bambilla are typical of the moist puna, while on the dry puna precipitation is reduced to 250 to 500 mm (Mann, 1968).

Weberbauer (1936) distinguishes five vegetation formations on the altiplano. First is the puna mat, occupying moist level areas with little rock. Densely packed mats of low herbaceous vegetation, cushion plants, and rosettes alternate with patches of bare ground. Few lichens, mosses, erect shrubs, or tall tufted grasses live in these mats. Hodge (1946) points out that cushion mats with Azorella sp. as the dominant species can be found over much of southern Peru between altitudes of 3800 and 5200 m. Second are the bunch, or "tussock" grasses which cover large areas of the altiplano. Tufts of these vigorous perennial grasses are surrounded with patches of open soil which support small numbers of dicotyledonous herbs and erect shrubs. The third formation is the Distichia moor. This formation requires constant ground humidity and is thus found near streams or small lakes on level, poorly drained ground. The dominant plant, Distichia muscoides, forms a closed, undulating surface firm enough to walk on, broken by pools of water. Distichia moors sometimes form peat (Weberbauer, 1936; Cabrera, 1968). Fourth is the vegetation found in rocky areas. Here one can find more abundant lichens, mosses, and ferns, in addition to erect shrubs, tall herbs, and tufted grasses. Vegetation in rocky areas reaches to higher altitudes than on bare earth, apparently because of the rock's capacity to retain heat longer than soil. The final formation is the small and infrequent groves of Polylepis, a twisted, stunted tree that resembles mountain mahogany and rarely grows taller than 3 m. Bunch grasses and herbs grow in the spaces between the

trees; the ground beneath them is bare. Polylepis grow to altitudes of 4600 m (Troll, 1968) and their distribution is apparently independent of ground water, slope, and soil conditions.

In a somewhat different description of vegetation, Cabrera (1968) recognizes two vertically divided provinces, the provincia puñena (3400 to 4300 m) and the provincia altoandina (4300 to 5000 m). The provincia puñena on drier soils is composed of isolated shrubs and diminutive herbaceous vegetation. In wetter areas of the central mountains, it is composed of pastures, small areas of sod and dense dwarfish grasses, and open stands of Polylepis. The provincia altoandina is made up of open xerophytic grasses. In more rocky areas it is composed of pulvinus dicotyledonous plants which find protection in the microrelief. This description of altiplano vegetation shares many features with the previous one of Weberbauer (1936).

In general, altiplano vegetation is herbaceous, perennial, and dwarf (Weberbauer, 1936; Hodge, 1946). Major families are Compositae, Gramineae, Leguminosae, Solanaceae, and Verbenaceae (Cabrera, 1968). Bulbous or tuberous plants and large shrubs or trees are scarce; the limited number of woody plants are evergreen (Hodge, 1946). Many of the cushion plants of the altiplano, as well as less specialized forms, are endemic (Weberbauer, 1936).

Quantitative studies of altiplano vegetation are limited; an exception is the recent work by Pearson and Ralph (1974). These authors have studied both bunch grass (ichu) and tola (small shrub) communities on the western altiplano of southern Peru. In the bunch grass study area (3900 m), 50% of the ground was covered with vegetation and half of this was attributed to ichu grass (usually Stipa ichu). Eighteen species besides ichu were identified in the study area. Most important were Calamagrostis cf. rigescens (9.3% cover) and Muhlenbergia fastigiata (6.6% cover). Stipa ichu is considered a "soft" bunch grass and is found between 3800 and 4100 m. Although Stipa ichu is listed as having low palatability (ONERN/CORPUNO Vol. IV, 1965), in the area studied by Pearson and Ralph (1974) it was heavily grazed along with smaller plants growing between the Stipa bunches.

Tola (usually Lepidophyllum or Baccharis), a small bush resembling sagebrush, is found on the drier, western portions of the southern Peruvian altiplano. In the study area chosen by Pearson and Ralph, ground cover was 33.3% distributed as follows: bunch grass (Festuca), 16.8%; tola (Lepidophyllum) 9.7%; dwarf bunch grass (Calamagrostis), 14.8%; a mat-forming "Senecio-like composite," 2%; and Pycnophyllum tetrastichum, 1%. Eight species were identified, and again, the area was heavily grazed. In both study areas nearly all of the vegetation was less than 0.5 m tall.

The height of vegetation and, in particular, the position of vegetative shoots in relation to the soil are important adaptive features and provide the basis for the lifeform classification system of Raunkaier (see Shimwell, 1972). Mann (1968) has described high-altitude Andean vegetation on the basis of this system and we repeat his description here (see Figure 13).

(1) Nanophanerophytes "bear their buds or shoot apices on negatively geotropic shoots in an exposed aerial position; < 2 meters tall."* In the highlands these plants are often resinous or oily, and may assume a creeping form (Chuquiragua, Adesmia, Nassauvia, Ephedra, Baccharis, Lepidophyllum).

(2) Chamaephytes are "woody or herbaceous, low-growing plants with buds produced on aerial branches close to the soil." In the highlands cushion forms are common (Mulinum, Azorella, Pycnophyllum).

(3) Hemicryptophytes "are characterized by degeneration of the shoots to the level of the ground at the beginning of the unfavorable period, so that only the lower aerial parts of the plant remain alive and bear buds at the level of the soil surface." In the high Andes these are rough, herbaceous, evergreen grasses (Festuca, Stipa, Poa, and rosette plants Plantago, Viola, Calycera) which press close to the soil.

(4) Geophytes are "terrestrial . . . plants whose buds or shoot apices survive the unfavorable seasons at varying depths below the ground." Highland representatives include Distichlis spicata, Psila, and Liliaceae.

*Definitions quoted from Shimwell (1972).

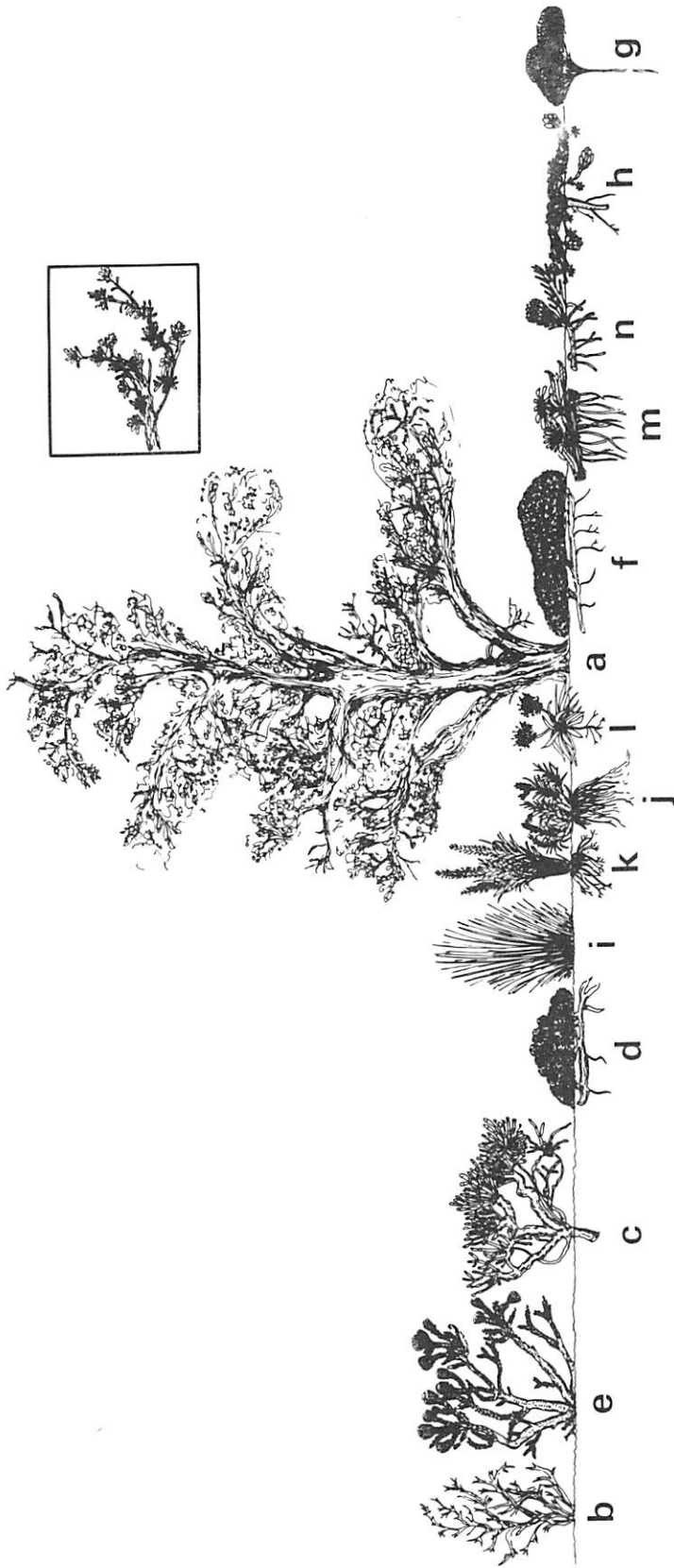


Figure 13. Typical altiplano plants illustrating the lifeforms found in the highlands of southern Peru. (1) Microphanerophyte: (a) *Polylepis tomentella*; (2) Nanophanerophytes: (b) *Adesmia horrida*, (c) *Ephedra americana*, (d) *Baccharis serpyllifolia*, (e) *Lipidophyllum quadrangulare*; (3) Chamaephytes: (f) *Azorella multifida*, (g) *Pycnophyllum molle*, (h) *Lupinus microphyllus*; (4) Hemicroptophytes: (i) *Festuca scirpifolia*, (j) *Poa chamaeclinos*, (k) *Calamagrostis vicunarium*, (l) *Plantago lamprophylla*; (5) Geophytes: (m) *Perezia coeruleascens*, (n) *Werneria pygmaea*. (Redrawn from Weberbauer, 1945; Mann, 1968; Troll, 1968; and from authors' photographs; reproduced with permission of the Institute of Ecology from Baker and Little, 1976.)

(5) Therophytes "are plants which survive the winter as seed, i.e., are annuals where the life cycle usually extends only from spring to autumn." No highland examples listed.

The biological spectrum of high-mountain vegetation in the Andes is thus: Nanophanerophytes, 15%; Chamaephytes, 20%; Hemicryptophytes, 45%; Geophytes, 18%; and Therophytes, < 2%. This can be compared to the Normal Spectrum (a randomly chosen composite of 1000 world species) which is Nanophanerophytes, 46%; Chamaephytes, 9%; Hemicryptophytes, 26%; Geophytes, 6%; and Therophytes, 13% (Shimwell, 1972).

The Raunkaier system of vegetation classification is based on structural characteristics which are functionally related to adaptive requirements, particularly those of climate. A comparison of Andean lifeforms with those of the Normal Spectrum reveals a disproportionate number of Chamaephytes, Hemicryptophytes, and Geophytes, all low and compact plants which protect important growth organs by keeping them below to only slightly above the soil surface. These lifeforms rely on the warmth and microrelief of the earth to provide protection against drought, frost, and wind. Many altiplano species are, to a greater or lesser extent, in the form of cushion plants (Weberbauer, 1936; Hodge, 1946). These range from dwarf and involuted shrubs and the tough bunch grasses which have the compactness of a straw broom, to Azorella, a plant which assumes the form of a small mound with a surface almost as hard as the soil that it resembles (Figure 13). These plants minimize external projections, reducing exposure. They tend to form closed surfaces, isolating the interior of the plant so that it is influenced by the relatively warm and moist soil environment. Cushion plants absorb water like a sponge (Hodge, 1946) and, aided sometimes by spines or sharp stiff branches, protect much of their structure from grazers.

Other adaptations of highland plants can be summarized as follows. (1) Root systems of highland plants are large and sometimes widely spread beneath the soil surface. Thick roots are common (Hodge, 1946; Cabrera, 1968), and roots are often woody rather than fleshy (Weberbauer, 1936). (2) Stems and branches of these plants are thick and

have parenchyma chlorophyll in the young shoots. They often have spines or other sharp projections. Parenchyma is reduced, sclerenchyma enlarged, and chlorenchyma can be found beneath the epidermis (Cabrera, 1968).* Slow growth, reduced size, and shortening of internodes lead to the rosette and cushion shapes discussed above (Cabrera, 1968; Troll, 1968). (3) Leaves and flowers are reduced in size, fleshy and leathery (Hodge, 1946; Cabrera, 1968; Mann, 1968). To reduce transpiration and dessication, leaves may be inrolled (Hodge, 1946; Cabrera, 1968), pubescent (Weberbauer, 1936), densely packed, and intricately surfaced. Anatomical adaptations include thick external walls, a thick cuticle, presence of wax or resin, and modification of stomates and parenchyma (Cabrera, 1968). One may also find high concentrations of cell liquids in these plants (Mann, 1968). These adaptations are common to plants that inhabit dry or cold environments (Daubenmire, 1947).

We are not aware of any actual measurements of the productivity of altiplano plant communities, however, some background information on this problem will serve to introduce an estimate made by Mann (1968). First, limited amounts of the highland soil surface are covered by vegetation. The figures provided by Pearson and Ralph (1974), 50% for Stipa ichu and 33.3% for a tola community, are probably on the upper end of the range for the altiplano as a whole. Rocky and exposed areas and areas of steeper slope generally support less cover than the flatter and lower-altitude Stipa ichu and tola communities. Second, the dwarf size and slow growth of altiplano plants, related to the absence of a "thermic season" for growth, and the low nightly temperatures (Troll, 1960; 1968) also inhibit productivity. These two factors, partial cover and dwarfism, will lower altiplano productivity relative to other environments. Poor soils, drought, and low partial pressure of carbon dioxide and oxygen must be considered as additional factors which could limit altiplano productivity. On

*Parenchyma is the fundamental tissue of plants composed of thin-walled cells. Sclerenchyma is supporting or protective tissue composed of thickened and indurated cells from which the protoplasm has usually disappeared. Chlorenchyma is parenchyma tissue containing chlorophyll.

the other hand, high insolation at tropical latitudes and high altitude should be favorable for productivity. Schwabe (1968) has suggested the diurnal temperature cycle may also aid net productivity. Strong insolation with warm temperatures encourages photosynthesis during the day, and low or freezing night temperatures inhibits the consumption of the photosynthetic products in nighttime respiration.

Ruthsatz (pers. comm., 1974) has estimated above-ground dry-weight biomass on the Argentine or "dry" puna, based on studies of vegetation cover (Ruthsatz, 1974) and weight measurement of dominant species, at between 2 and 4 t ha⁻¹. Specifically, Ruthsatz's estimates are as follows: high Andean grassland (4500-4900 m, Festuca spp., Deyeuxia spp., and Stipa spp. bunch grasses on azonal soils), 2 t ha⁻¹; mixed bunch grass and evergreen bush vegetation on high slopes (4100-4500 m, Festuca spp., Deyeuxia spp., Stipa spp., Baccharis spp., Parastrephia spp., Chiloticichopsis spp., etc.) 4 t ha⁻¹; and puna-summergreen shrubland (3300-4100 m, Baccharis spp., Fabiana spp., etc.) 2 t ha⁻¹. Primary productivity information is not yet available for these vegetation areas.

For southern Peru, Mann (1968) makes two estimates of altiplano productivity based on biomass data given by Pearson (1959). For the wet puna (Calamagrostis, Muhlenbergia, Nassauvia, Oreomyrris, Geranium, Erodium, Bromus, Festuca), Mann derives a standing crop of 7000 kg dry matter ha⁻¹, which is calculated to provide an "annual harvest" of 80 kg dry matter · ha⁻¹ · yr⁻¹. The same figures for the dry puna (Notoriche, Geranium, Astragalus) are 2000 kg dry matter ha⁻¹ standing crop, and 3 kg dry matter · ha⁻¹ · yr⁻¹ "annual harvest." For comparison, net primary productivity (mean) for temperate grasslands is 5000 kg dry matter · ha⁻¹ · yr⁻¹, and for dwarf and open scrub it is 900 kg dry matter · ha⁻¹ · yr⁻¹ (Leith, 1973). Mann's (1968) use of annual harvest may not be equivalent to net primary productivity, and his figures do appear conservative. Nevertheless, until productivity measurements are obtained for the altiplano, it appears that highland energy production is low (and low in relation to biomass), and it is dispersed over wide regions. Much of the productivity is accumulated beneath the soil surface.

FAUNA

Given the aforementioned environmental constraints, we might expect to find a limited fauna on the altiplano. Herbivores, for instance, must cope not only with the rigors of climate and topography but also with the tough and energetically limited vegetation that is available as a food source. Many of the qualities of highland plants that enable them to survive cold, wind, and drought can also be viewed as adaptations which inhibit grazing or browsing. Grazing inhibitors include subterranean growth or growth between rocks and in crevasses, rosette or cushion form, stiff, short and sometimes spiny branches, reduced foliage and flowers, and an absence of fruit. The oils, resins, and waxes found in highland plants, as well as their generally high content of cellulose and silica (Mann, 1968), also reduce their palatability.

Concerning faunal diversity, Fittkau (1968) states that the Andean-Patagonian region is extraordinarily poor in species number, not only compared to the tropical area of the same continent, but also in comparison with the ecologically similar life zone of Holarctis. This faunal impoverishment argument is supported by Simpson (1968); however, there are exceptions. While reptiles and amphibians are fairly scarce and live in and around lake habitats (Cabrera, 1968), the altiplano supports numerous endemic species of birds and small mammals (Pearson and Ralph, 1974).

Pearson and Ralph (1974) point out that the number of bird species in the dry puna ichu bunch grass community is unusually high and the number of species of small mammals is similar to that of North American grasslands. Species diversity (an index based on the number of species and the proportional population density of each species) is considerably above average, suggesting an equitable partitioning of resources. Comparing this information on diversity with theoretical models of species evolution proposed by Tramer (1969), Pearson and Ralph (1974) conclude that small mammals are responding as though the highland environment is predictable and nonrigorous. Nevertheless, population density and biomass of small mammals is low. The biomass for

small mammals is 115.0 g ha^{-1} , whereas that for birds is 463.6 g ha^{-1} , four times greater (Pearson and Ralph, 1974). An abundant number of carnivorous mammals (Mann, 1968) and birds (Olrog, 1968) are able to make use of the herbivore fauna, although some of the carnivores eat vegetable matter at certain times of the year (Mann, 1968). The diversity of mammals and birds on the altiplano arises from the faunal history (biogeography) of the region, and from the adaptive flexibility of the animals involved. Each of these factors will be briefly discussed below.

South America was an isolated continent during most of the history of mammalian evolution (the Cenozoic), and became connected with North America in the early Pleistocene, 2 to 3 million years ago. At this time temperate-adapted, placental mammals began to move into South America and along the Andes in large numbers, displacing the endemic marsupials, edentates, and ungulates. The immigrants included rabbits, noncaviomorph rodents, placental carnivores, procyonids (such as the raccoon), mastodonts, horses, tapirs, peccaries, camelids, and deer (Simpson, 1968), and species of birds (Fittkau, 1968). These immigrants have populated much of South America. As a whole they make up about half of the fauna of the continent, and much of that in the highlands (Simpson, 1968). Other animals have evolved within the Andean and surrounding regions. Although the evolution of these forms is limited in time by the appearance of cold-temperate to subarctic environments in the Miocene, physical and climatic events of the Pleistocene have contributed actively to speciation. The alteration of glacial and nonglacial climates and the accompanying movement of vegetation zones, and the division and isolation of populations by repeated occurrences of glaciers, glacial lakes, vast outpourings of volcanic ash, and tectonic activity have offered ideal conditions for specific radiation of endemic and immigrant mammals and birds in the high mountains (Vuilleumier, 1971).

Another aspect of mammalian and avian diversity on the altiplano is the great adaptive capacity of these two groups. For instance, animals which at lower altitudes are nocturnal become active in the daytime in the higher areas. Similarly, animals which are food

specialists at lower altitudes may become euryphagous in the high mountains. Movement to high altitude may also mean a retardation of development. A form which has two to three generations per year at low altitude may in high mountain habitats have only one (Mann, 1968). This retardation of growth is similar to that seen in plants.

Surprisingly, the low oxygen tension of the altiplano appears not to be an important limiting factor in the distribution of highland mammals. This is not because chronic hypoxia is an insignificant stressor; the importance of hypoxia is confirmed by observing the responses of lowland species to altitude (Morrison, 1962; Altland and Highman, 1971). Rather, with few exceptions native highland mammals have successfully adapted to this everpresent and rather intense stressor.

Bullard (1972), in reviewing physiological responses to chronic hypoxia, divides mammals into two broad groups. The first group shows a typical normoxic-type response to hypoxia by increasing the hematocrit ratio or hemoglobin concentration in the blood, and possibly shifting the oxygen dissociation curve to the right (indicating a lowered blood oxygen affinity). This pattern of adjustment contrasts to that of the second group: the high-altitude native species. Elevated hematocrit ratio and hemoglobin concentration noted above are not present in genetically isolated highland mammals. These species tend to show a leftward shift in the dissociation curve (an increased affinity for oxygen). Morrison et al. (1963a and b), for instance, found no correlation between hematocrit values and altitude of origin of Andean rodents. This confirmed earlier findings of low hematocrit values for llamas and vicuñas (Hall et al., 1936). Exceptions to these results include highland species with continuous genetic admixture from adjacent lowland areas, and perhaps humans (Morrison, 1964). Bullard (1972) states that elevated hemoglobin and hematocrit ratio do not appear to yield any selective advantages, and in fact may impose serious hemodynamic consequences (Smith and Crowell, 1963). In addition, several studies (Turek et al., 1973; Eaton et al., 1974) have shown that a rightward shift in the dissociation curve has a favorable effect only in the range of normoxia or moderate hypoxia; there is a detrimental effect with severe hypoxia.

Other physiological characteristics of native high-altitude species have been summarized by Bullard (1972) and Folk (1974). These include a longer erythrocyte survival time (at sea level), and an increased plasma volume compared to lowland animals exposed to chronic hypoxia. Based on more limited evidence, Bullard (1972) suggests that high-altitude animals show a greater ability for tissue function at a low oxygen tension or under anaerobic conditions, and a greater ability to regulate tissue oxygen tension by maintaining circulatory and respiratory functions.

Unfortunately, the only highland mammals extensively studied, with the exception of humans, have been rodents and camelids. It is possible that these animals possess special lowland characteristics which enabled them to successfully move into high-altitude regions (Bullard, 1972). In rodents, for instance, adaptations for burrowing (Darden, 1972) may be of value in adjusting to an hypoxia environment. Camelids as a family have smaller red blood cells, and hence an increased surface area for oxygen diffusion. This, in part, accounts for their characteristic leftward oxygen dissociation curve which is present in both high-altitude and lowland species (Chiodi, 1970-71). One must, therefore, question whether these physiological characteristics are uniquely the result of a single environmental stressor (i.e., high-altitude hypoxia).

Pearson (1951) states that the ability to live in an open and dry habitat, to secure sufficient food from sparse vegetation, and to survive and reproduce under the peculiar thermal conditions of the altiplano may be more important than physiological adaptations to hypoxia. Koford (1957) makes much the same comment referring specifically to the vicuña. Many characteristics of altiplano mammals and birds can be related to the factors Pearson (1951) mentions above. These include (1) use of ground or air warming by restriction of activity patterns, usually diurnal (Pearson, 1951; Mann, 1968); (2) living in burrows, caves, or amongst rocks and cliffs (Pearson, 1959; Mann, 1968); (3) hard and continuously growing incisor teeth and specialized (ruminant) digestion (Mann, 1968); and (4) thick fur,

dense plumage, and subepidermal adipose tissue (Pearson, 1951; Cabrera, 1968; Mann, 1968). Running species are common on the altiplano as are rodents (Mann, 1968); many species of birds are ground feeders (Pearson and Ralph, 1974).

In summary, examples of physiological, morphological, and behavioral adaptations of highland biota have been given. Little has been said, however, about the adaptive characteristics of altiplano populations as a whole. Based on theoretical arguments (Levins, 1968), we would expect organisms living in a fluctuating and variable environment to demonstrate a high degree of adaptive flexibility. This flexibility could be genetic (ecotypic varieties or subspecies), or it could be achieved by a high emphasis on phenotypic plasticity. Billings (1973) has pointed out that both of these mechanisms of adjustment are found in alpine flora, and ecotypic varieties are common among Andean cultigens (Simmonds, 1965; Cardenas, 1969; Ugent, 1970). To date, however, too few studies have been concerned with this problem to draw any definite conclusions.

HUMAN-ENVIRONMENT INTERACTION

Thus far we have discussed the physical and biotic environment of southern highland Peru without considering human populations or their historical influence on the substrate, flora, and fauna of the region. The remainder of this report will deal more explicitly with human populations and with the human-environment interactions that are the subject of contemporary interest. We recognize humans as the ecological dominants in this system. The environment of the high Andes is the product of centuries of coadaptation of human and non-human populations, both interacting with substrate. Humans have been, and continue to be, the major factor in determining this ecosystem's structure and viability.

Human groups in the high Andes have diverse individual- and group-level adaptive patterns. Here we have taken only one group into consideration as a primary example. It is fairly isolated and contains about 8000 persons still largely dependent on a mixture of agriculture and pastoralism. Our choice of a single example requires that we ignore some of the adaptive diversity that is characteristic of the Andean highlands, but aside from our familiarity with, and the fairly extensive information on, the present example, there are reasons for this focus. Agricultural pastoralists have been historically and are presently the predominant type of human groups in tropical high mountains. It is this system which has most closely determined the coevolution of the human population and natural resource base. Agricultural pastoralists remain a numerically large group in the Peruvian Andes. Their daily interaction with the local environments that support them and their dependence on these environments are vital as their present livelihood is marginal and is dependent on foodstuffs and other resources produced largely from a local ecological base. Consequently, they are the first to feel the effects of environmental deterioration; the environmental balance becomes all the more critical as these groups are often the targets of planned change or the agents of unplanned change. In addition, the geographically isolated highland zones are often also remote from the

national culture and political and economic priorities of lowland governments. Governmental unfamiliarity with highland ecology and adaptive patterns can itself exacerbate highland problems.

To provide the reader with a feeling for the kind of human adaptive system we are referring to, and to give a specific context to the generalizations that follow, we present here a description of the agricultural and pastoral ecology of the district of Nuñoa, Department of Puno. This description represents a summary from an extensive literature on human adaptation in this community (see Baker and Little, 1976, for a more detailed review and list of references).

The Nuñoa Ecosystem

The District of Nuñoa (Melgar Province, Figure 14) covers approximately 950 km², and is located on the northeastern boundary of the Titicaca Basin. Much of the district consists of the watersheds of the Nuñoa and Corahuina rivers. Additional elevation within Nuñoa rises in a northerly direction from 4000 to 5500 m. Except for the southwestern sector, it is encompassed by a series of higher and frequently snow-capped ranges which make up the western flank of the Cordilla Oriental. To the west these separate Nuñoa from the upper regions of the well-traveled Ayaviri Valley, to the north from the headwaters of the Vilcanota River, and to the east from the precipitous Andean escarpment. While various passes permit access to these regions, the higher ranges to some extent act as natural barriers. This is especially true for vehicular transportation, but applies less to travel on foot or by horse. One all-season road (indicated by a dashed line on all maps of the Nuñoa region) connects the town of Nuñoa with Santa Rosa in the Ayaviri Valley. The Nuñoa District is one of the higher and more remote areas within the southern Peruvian altiplano. Isolation allows us to consider the district not only as a political unit, but as a bounded ecosystem as well.

Landscape

The Nuñoa terrain reflects the drainage pattern of the Nuñoa and Corahuina rivers and their tributaries. Both commence in permanent snowfields lying beyond the northern perimeter of the district. The

snowfields serve as reservoirs, providing almost continuous runoff regardless of the rainfall pattern in the area below. Streams resulting from melted snow descend rapidly through steep-walled, narrow valleys to an altitude of approximately 4800 m. Thereafter, a definite valley floor becomes apparent and gradually enlarges to a breadth of 0.25 km. The actual riverbed frequently lies 25 to 50 m below this floor. Hills bordering the high river valleys are gently graded and rise smoothly 200 to 400 m, with catenary curves and interlocking spurs. Their mature slopes indicate extensive weathering and erosion. Rugged spurs, serrate chains, and needles or horns are not common topographic features of the lower hills. As the valley floor drops below 4050 m, its configuration alters. The hillsides are steeper and drier and the river descends more slowly over a flat valley floor several kilometers wide. The valley reaches a maximal breadth of more than 10 km below the town (Figure 10); this is one of the drier areas in the district, water flow is restricted to a few isolated streams and the two rivers. With the exception of these, several marshes and two permanent lakes, vegetation on the lower valley floor is dependent upon precipitation as a water source.

Climate Characteristics

Little (1968) has reviewed meteorological information collected in Nuñoa between August 1964 and December 1965. This has been supplemented by records extending up to August 1966 by Baker *et al.* (1968) and for 1968 by Thomas (1973). Data are based on recordings from several weather stations placed at varying altitudes on the valley floor and hillsides.

Compared to Chuquibambilla (3910 m) in the Ayaviri Valley, data available from the town of Nuñoa (3974 m) indicate that both precipitation and mean minimal temperatures are somewhat less in the higher Nuñoa valley (Figures 3 and 4). Freezing temperatures are of considerable import with regard to vegetational types which can be supported in the district. It is apparent that frosts can occur at any time throughout the year (Figures 4e and 4f). They are, however,

most frequent above 4000 m in June and July and least prevalent from December to March. At 4500 m frost occurs almost nightly. Nocturnal temperatures on the lower hillsides remain slightly above those of the valley floor as a result of thermal inversion. It is on these lower hillsides that most horticulture takes place; the valley floor is cultivated only below 4000 m.

Precipitation may take a wide variety of forms. While hail and snow appear throughout the year, they are most frequent in the months directly preceding and following the cooler, dry season. It is estimated that frozen precipitation makes up about 10% of the annual precipitation in lower areas of the district (Little, 1968), and this increases curvilinearly with altitude.

In late September intermittent precipitation signals the onset of the rainy season. Significant rainfall generally begins in October, reaches a peak in December and January, and subsides in April. The typical diurnal pattern during this time consists of clear skies in the early morning with increasing overcast and precipitation in the afternoon. Despite the apparent uniformity in climatic pattern described above, considerable variation exists, first between areas within Nuñoa, and second within a given area from year to year. It is not unusual, for instance, for one valley system to receive rain while adjacent ones remain dry. Climatic instability is greatest during the transitional period between the wet and dry seasons.

Besides local variability in the precipitation pattern there are occasional nonregular climatic disruptions that extend throughout the altiplano region. One such disruption is long-term (up to three years) drought. In 1939-40 (Figure 6) and 1956-57, the District of Nuñoa, along with most of the Department of Puno, suffered such conditions. Effects were apparent along the entire food chain. Permanent water sources dried up, crops were lost, large numbers of livestock died, and many families were forced to temporarily migrate to lower ecozones. Since then a number of less severe droughts have occurred. A second nonregular disturbance is a dynamic frost or friagem. An example recorded in June 1968 (Figure 5d) has been previously mentioned.

Data on potential evaporation and solar insolation are given in Figures 4d and 5b, respectively, and information concerning geological formations, subclimatic types, and soil groups is presented in Figures 9, 10, and 15.

Wild Plants

Nuñoa is situated in the wet puna, much of it falling within what Cabrera (1968) refers to as the provincia altoandina. Ecological formations, vegetative associations, and land-use capacity of the district are described and mapped in Figures 16-18. Considering the natural flora of principal value to the human population, over twenty varieties of grass suitable for pasture have been identified within the district (Table 1). Of these, ecological dominants at lower elevations are the ichu bunch grasses (Stipa ichu and Festuca dolico-phylla; Figure 19). Above 4250 m these become less abundant and are eventually replaced by shorter bunch grasses. Ichu is one of the more important nonedible plant resources used by the human population. When cut, the long rigid stems serve as a roofing material on almost all rural dwellings. It is employed in dehydrating potatoes, storing potato seed, and in making twine. In view of its multiple uses, access to a source of ichu is considered necessary by the Nuñoa rural native.

Although Nuñoa lies considerably above the present-day timberline, scattered pockets of small, slow-growing queñua trees (Polylepis incana) appear on protected slopes below 4250 m. While limited in distribution, these trees are used for roof supports, cooking utensils, stirrups, and spindle whorls. The queñua wood is generally not suitable for the straight shafts needed in agricultural tools, and therefore these must be obtained from trees found outside Nuñoa. The queñua tree is rarely used as a fuel source by the rural population since dung is readily available. Dung is also used as the principal fertilizer throughout the district (Winterhalder et al., 1974).

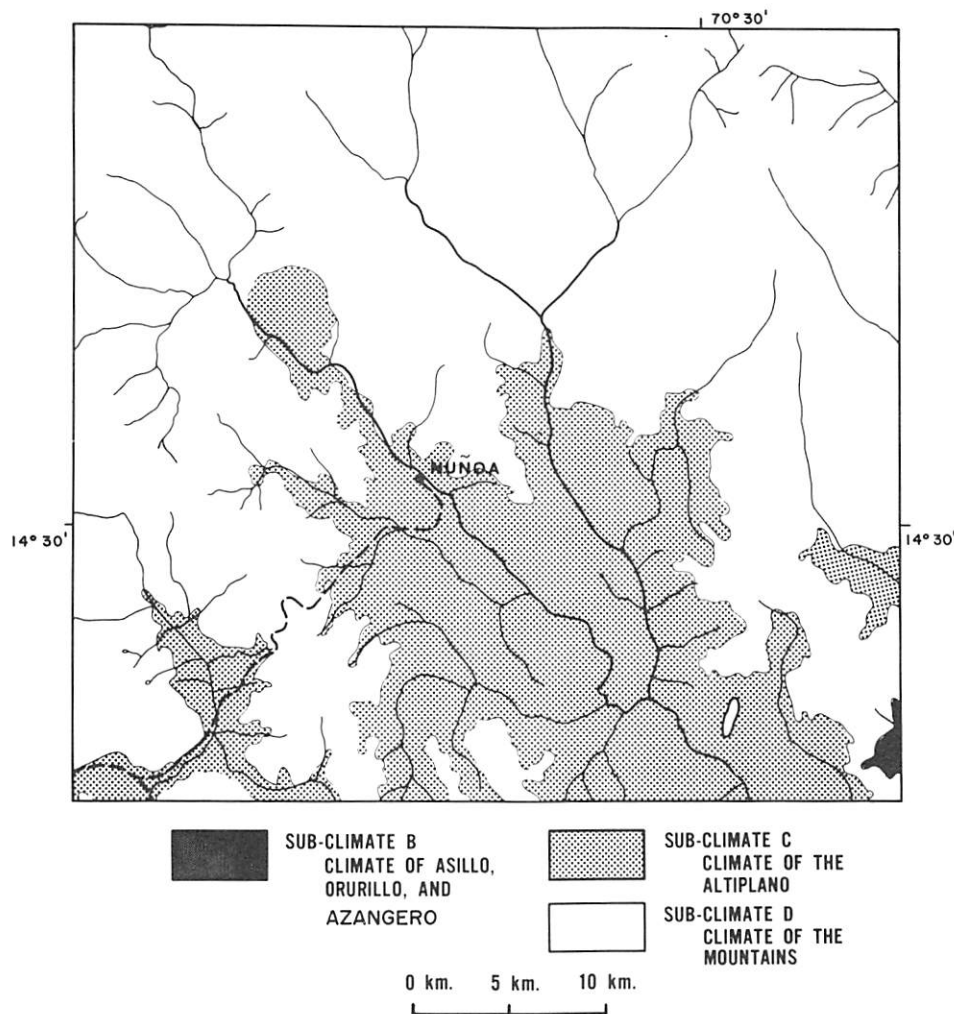
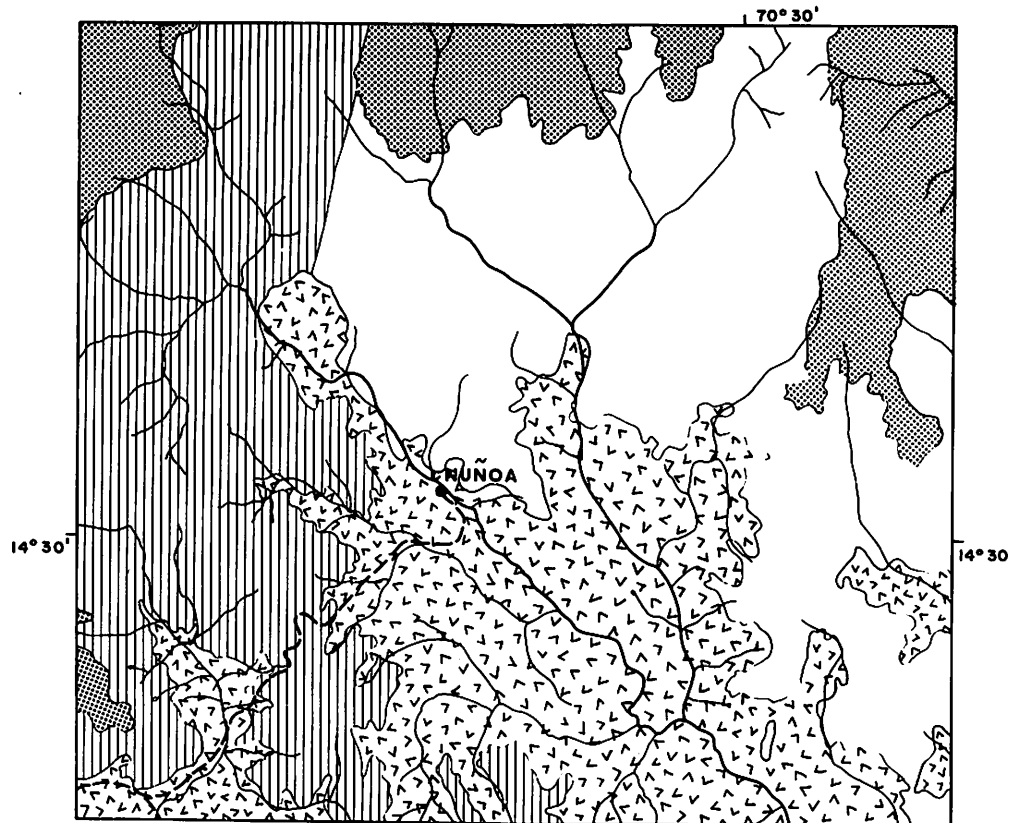


Figure 15. Subclimatic types of the Nuñoa area. Subclimate type B: climate of Asillo, Orurillo, and Azangero. Mean maximum daily temperature, 18.9°C; mean minimum daily temperature, 0.1°C; mean annual temperature, 10.4°C; mean daily temperature range, 18.8°C. Mean annual precipitation in this climate type, which is the most uniform in variation and distribution of the three types considered, is 88 cm. Subclimate type C: Mean maximum daily temperature, 20.4°C; mean minimum daily temperature -6.7°C; mean annual temperature 6.6°C; mean diurnal temperature range, 27.1°C. Intense frosts occur in this zone. Average annual precipitation is 64.4^o cm. The variation and distribution of precipitation in some localities is not uniform. Mean annual atmospheric pressure is 630 mm Hg. Subclimate type D: climate of the mountains. Extensive data do not exist for this type of climate, however, data gathered by Baker *et al.* (1968) for 14 months at an altitude of 4540 m provides the following information: mean maximum daily temperature, 9.8°C; mean minimum daily temperature, -2.3°C; the mean annual temperature, 3.8°C; mean diurnal temperature range, 17.5°C. Temperatures below freezing were observed on 97.9% of the days recorded. (Redrawn from ONERN/CORPUNO, Vol. I, 1965; reproduced with permission of the Institute of Ecology from Baker and Little, 1976.)

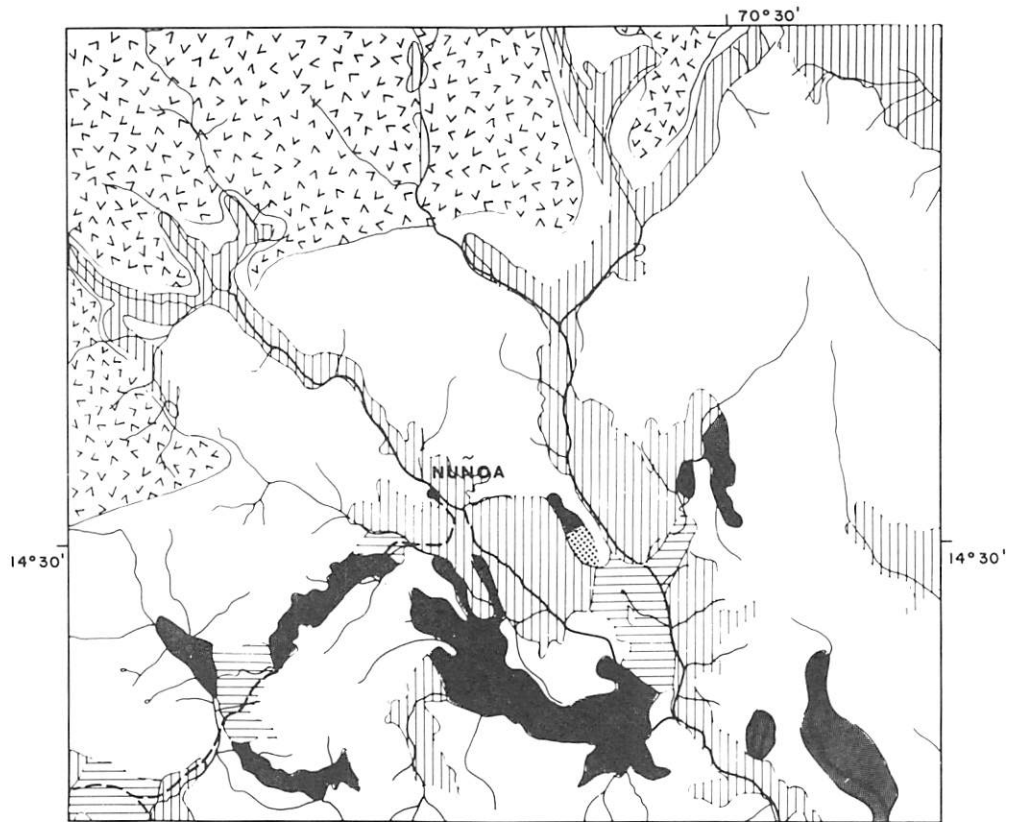
Figure 16 (page 60). Ecological formations (after Holdridge, 1967) of the Nuñoa area. Pradera o Bosque Humedo Montaño: Agriculture and pasturage, moist montane forest at 3900 m. Mean annual temperature 8.7°C, with a mean oscillation of 8.0°C; annual precipitation 72.5 cm. Vegetation is characterized by the diversity and density of species and has a high percentage of herbaceous grasses of good vigor and abundant shrubs, although trees are rare due to heavy human use. Monte o Paramo muy Humedo Sub-Alpino: pasturage (principally sheep and camelids); sub-alpine paramo at 4100 to 4600 m. Mean annual temperature, 5.5°C, with a mean oscillation of 15°C; annual precipitation, 80 cm. Vegetation is herbaceous, shrubby and woody, with herbs of high fiber content and low palatability. Existing forests are small and are found only in isolated areas inaccessible to man and herds. Monte o Paramo Humedo Sub-Alpino: pasturage (principally sheep and camelids); sub-alpine moist puna at 4100 to 4600 m. Mean annual temperature 5.5°C, with a mean oscillation of 15°C; annual precipitation is 50 cm. Tall grasses and dwarf shrub vegetation predominate, dense cover formations found in sheltered mountain declivities or on small areas of pasture. Tundra Muy Humedo Alpino: pasturage; (limited to camelids); wet alpine tundra at 4600 to 4800 m. Mean annual temperature, 2.5°C, with a mean oscillation of 15°C; annual precipitation, 50 cm. Vegetation consists largely of rosette and cushion species elevated only 2 to 5 cm above the soil. (Redrawn from ONERN/CORPUNO, Vol. IV, 1965; reproduced with permission of the Institute of Ecology from Baker and Little, 1976.)

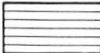
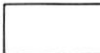



Figure 17 (page 61). Vegetation associations of the Nuñoa area. Calamagrostetum (crespillo): association defined by Calamagrostis densiflora, found on areas of moderate slope, tolerant of low temperatures, frost resistant, and requires about 60 cm of precipitation. The dominant has only moderate palatability, but protects the interstitial and more palatable species by moderating temperatures and impeding evaporation of water from the soil. Supports 2.5 to 3 sheep ha⁻¹. Festucetum-Muhlenbergetum (chillihuaires and gramales): co-dominants are Festuca dolychophylla (20 to 30%) and Muhlenbergia ligularis (15 to 25%). Found on gentle slopes below 4100 m, with temperatures of 6 to 9 C. Good to excellent pasture, supporting 3 to 3.5 sheep ha⁻¹. Stipetum-Margiricarpetum (canllares): named after Stipa and Margiricarpus strictus. Association indicates degradation of pasture lands as Margiricarpus occupies superficial and degraded soils or xeric pastures. The annuals are palatable but ephemeral and of little importance. Stipetum (pajonal or ichal) named for the genus Stipa. Found on steeper slopes, areas of recent soil formation, or degraded meadows. Chief value is erosion prevention. Existing grasses are of low palatability and have little nutritive value. Camelids will, however, consume some species of Stipa. Capacity is 0.5 sheep ha⁻¹, and is derived primarily from the annuals. Calamagrostetum antonicus (pajonal de cerro): defined by the species Calamagrostis antonianus, but Festuca heterophylla and Stipa obtusa are codominants. Found in rocky areas and on mountain declivities. Valuable solely for soil protection; very fibrous and contains abundant silica. Camelids will consume plants in this association, but prefer other pasturage. Capacity is the equivalent of 1.5 sheep ha⁻¹. (Redrawn from ONERN/CORPUNO Vol. IV, 1965; reproduced with permission of the Institute of Ecology from Baker and Little, 1976.)



- | | | | |
|---|---|---|-------------------------------------|
|  | PRADERA Ó BOSQUE
HÚMEDO MONTANO |  | MONTE Ó PÁRAMO
HÚMEDO SUB-ALPINO |
|  | MONTE Ó PÁRAMO MUY
HÚMEDO SUB-ALPINO |  | TUNDRA MUY
HUMEDA ALPINO |

0 km. 5 km. 10 km.



- | | | | |
|---|---------------------------------|---|-----------------------------|
|  | CALAMAGROSETUM |  | STIPETUM |
|  | FESTUCHETUM -
MUHLEMBERGETUM |  | CALAMAGROSETUM
ANTONICUS |
|  | STIPETUM - MARGIRICARPETUM | | |

0 km. 5 km. 10 km.

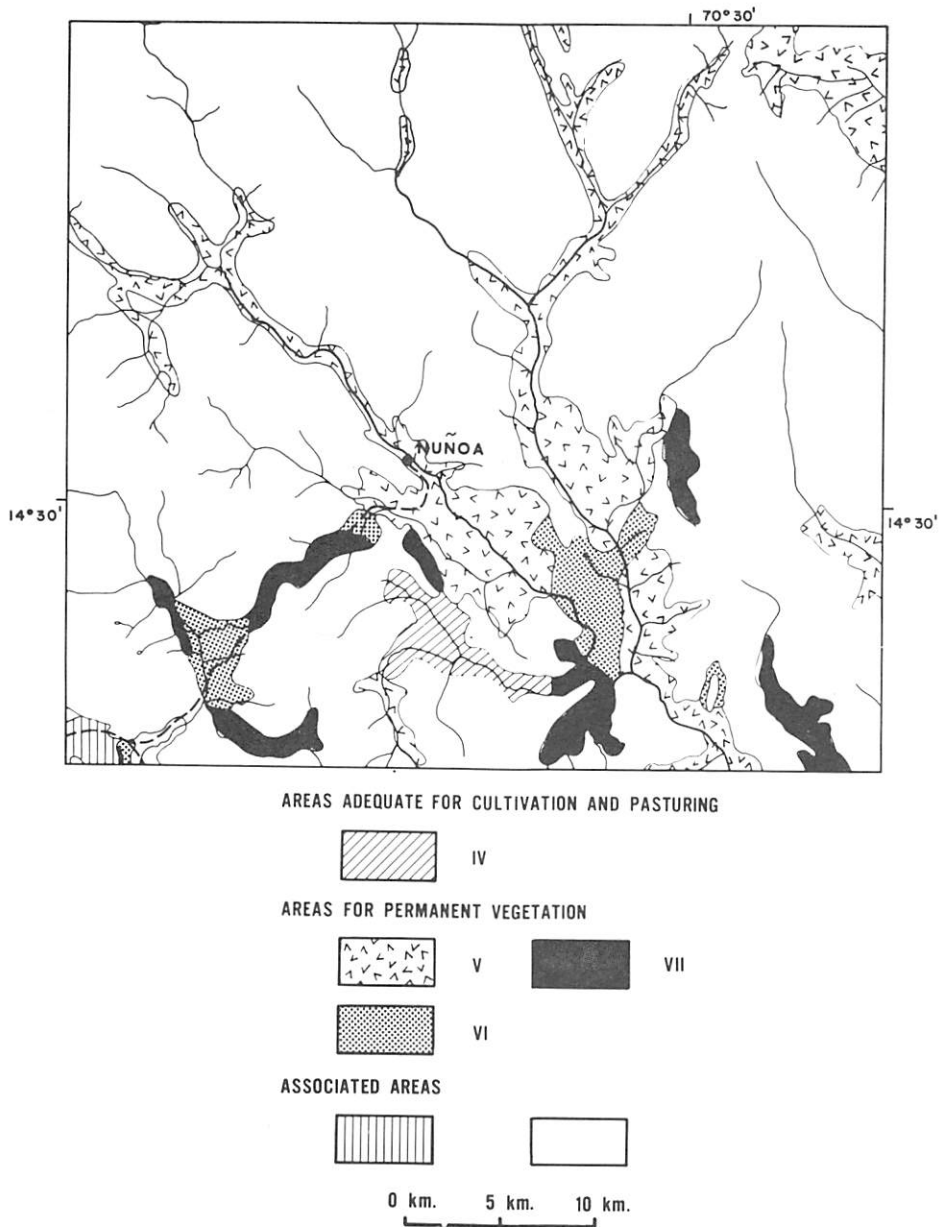


Figure 18. Land-use capacity of the Nuñoa area. Areas adequate for cultivation and other uses: (IV) Land good for intense cultivation of high-altitude crops and pastures; limitations primarily those of soils. Areas for permanent vegetation: (V) Land good for limited cultivation of high-altitude crops and intense pasturing on cultivated or otherwise improved vegetation; (VI) Land moderately good for pasture with improvement of the vegetation base. Limitations are superficial soils, excessive rockiness, poor drainage, and susceptibility to erosion; (VII) Land which can be used for extensive pasturing based on natural vegetation. Limitations are very superficial soils, excessive rockiness, poor drainage, and susceptibility to erosion. Associated areas: (1) Mixed area; land

Over 100 different plants of the Nuñoa area are used either as food or for their medicinal properties. Of the foods, approximately 20 appear almost daily in the diet. Use of herbs is most prevalent during the latter part of the rainy season but dried forms are used throughout the year.

Domestic Plants

Within the District of Nuñoa the principal cultigens are Andean-domesticated cereals and tubers. Their relative hardiness is indicated by the uppermost elevation at which they are grown effectively and productively (see Figure 20 and Table 2). Andean cereals of importance are quinoa (Chenopodium quinoa) and cañihua (Chenopodium pallidicaule) (Figure 21). Quinoa is generally restricted to below 4250 m, whereas cañihua cultivation has been observed as high as 4450 m. Although Old-World grains (barley and oats) are occasionally grown by the rural population, they appear less resistant to environmental conditions, and their distribution is generally limited to a few well protected lower slopes. These cultigens frequently bend and snap under a heavy snow, their grains have a greater tendency to become dislodged during a hail storm, and they are more dependent upon moist soil conditions than the Andean cereals.

Five Andean tubers are grown within the district: oca (Oxalis crenata), ulluco (Ullucus tuberosa), isaño (Tropaeolum tuberosum), and the dulce (Solanum andigenum) and amarga potato (Solanum curtilobaum). Of these, the potatoes are hardier and more extensively relied upon. The dulce potato produces best up to 4250 m, whereas the more frost resistant amarga potato is grown as high as 4450 m. Both potatoes and the Andean cereals are cultivated within altitude-specific

Figure 18 (cont.). very good for intense cultivation of high-altitude crops and pasture (some soil limitations), mixed with type V. (2) Mixed area; land without agronomic use (limited by excess salinity, poor drainage, extreme topography, and rigorous climate), mixed with type VII. (Redrawn from ONERN/CORPUNO, Vol. III, 1965, following established categories; reproduced with permission of the Institute of Ecology from Baker and Little, 1976.)

TABLE 1

CLASSIFICATION OF PASTURE SPECIES ACCORDING TO QUALITY^a

<u>Scientific Name</u>	<u>Quechua Name</u>
High Palatability	
<u>Alchemilla pinnata</u>	<u>sillo sillo</u>
<u>Bromus unioloides</u>	<u>cebadilla</u>
<u>Calamagrostis heterophylla</u>	<u>sora sora</u>
<u>Festuca dolichophylla</u>	<u>chillihua</u>
<u>Hypochoeris</u> sp.	<u>pilli pilli</u>
<u>Hordeum muticum</u>	<u>cola de ratón</u>
<u>Muhlenbergia ligularis</u>	<u>grama dulce</u>
<u>Cyperus</u> sp.	--
<u>Poa candamoana</u>	<u>grama</u>
<u>Trifolium amabile</u>	<u>trebol</u>
<u>Erodium</u> sp.	<u>auja auja</u>
<u>Gnaphalium</u> sp.	<u>januncara</u>
Medium-to-Low Palatability	
<u>Calamagrostis vicunarum</u>	<u>ñapa pasto</u>
<u>Calamagrostis rigida</u>	<u>mula pasto</u>
<u>Calamagrostis</u> sp.	<u>huaylla ichu</u>
<u>Geranium</u> sp.	<u>ojotilla</u>
<u>Muhlenbergia peruviana</u>	<u>llapa</u>
<u>Juncus</u> sp.	<u>junquillo</u>
<u>Stipa</u> sp.	<u>ichu</u>
<u>Plantago</u> sp.	<u>llanten</u>
<u>Oxalis</u> sp.	<u>añas cebolla</u>
<u>Gomphrena</u> sp.	<u>pilli plateado</u>
<u>Scirpus</u> sp.	<u>totorilla</u>

^aAdapted from Deustua (1972). Reproduced with permission of the Institute of Ecology from Baker and Little (1976).



Figure 19. Ichu bunch grasses (*Stipa* sp.) predominate on the valley floors (4000 m) of the altiplano, while shorter grasses become more abundant at higher elevations, especially in the smaller valleys. The frost desert and snowfields lie above. The specific altitudes of these features are given in Figure 20.

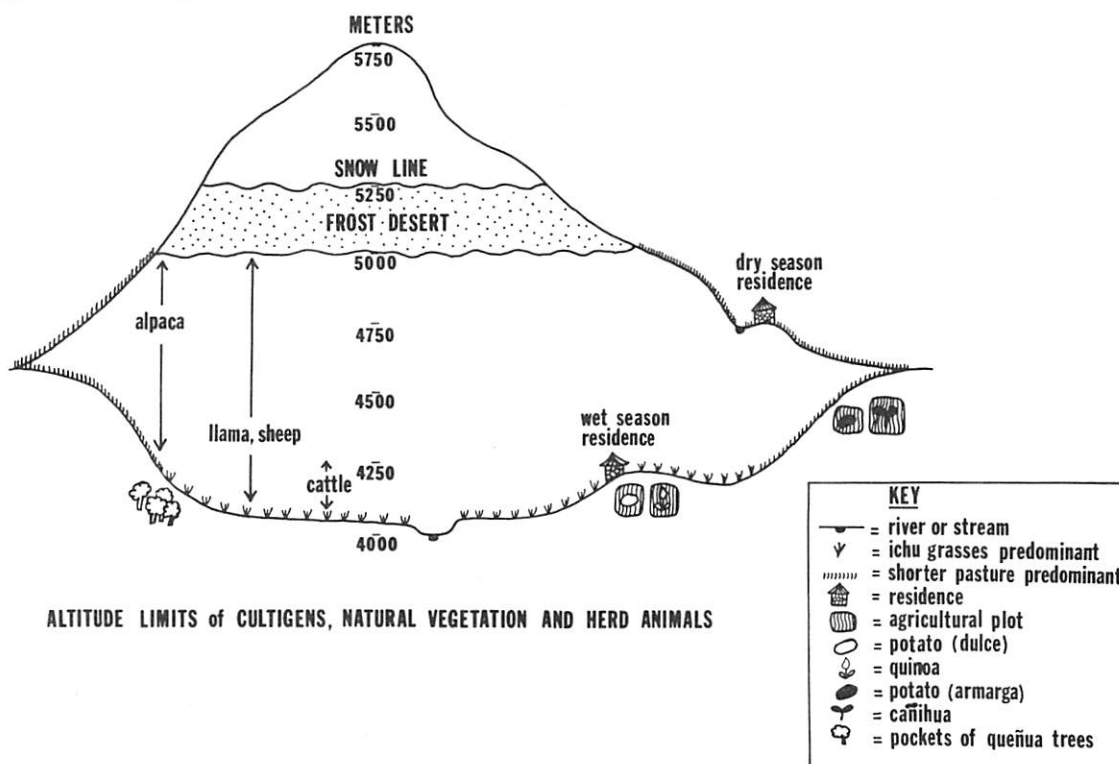


Figure 20. Altitude limits of cultigens, natural vegetation and herd animals in Nuñoa. (Reproduced with permission of the Institute of Ecology from Baker and Little, 1976.)

TABLE 2
DOMESTICATED FOOD SOURCES IN THE NUÑO A ECOSYSTEM^a

<u>Food Source</u>	<u>Reliance</u>	<u>Altitude Limit (m)</u>	<u>Conditions of Production</u>
Cultigens			
Andean tubers			
Potato (<u>amarga</u>)	High	4450	In general, planted on ridged fields with fertilizer. Potatoes are the hardiest; the <u>amarga</u> has a greater yield than the <u>dulce</u> . Rains after planting allow young plants to grow rapidly and large enough to prevent frost damage. With too much rain late in the growing season, potato worms increase.
Potato (<u>dulce</u>)	High	4250	
<u>Oca</u>	Low	4200	
<u>Isaño</u>	Low	4200	
<u>Ulluca</u>	Low	4200	
Andean cereals			
<u>Cañihua</u>	High	4450	Planted on last year's potato field. Little preparation and no fertilizer needed. Since <u>quinoa</u> grows best in wetter, and <u>cañihua</u> in drier seasons, these grains are frequently planted together. <u>Cañihua</u> is less affected by snow and withstands harsher conditions.
<u>Quinoa</u>	High	4250	
Old-World grains			
Barley	Mod.	4200	More susceptible than Andean cereals to frost, hail, and snow. Generally grown in sheltered areas. Seed must be obtained in lower ecozones. Barley, the most successful, is frequently used as a food supplement for livestock.
Oats	Low	4100	
Wheat	Low	4100	
Other			
Onions	Low	4100	Grown in sheltered areas in the lower parts of the ecosystem. Affected by frost; thus limited. Wild plants are frequently relied upon for leafy vegetables and fruits.
Beans	Low	4100	
Leafy vegetables	Low	4100	
Domesticates			
Andean camelids			
Llama	Mod.	5000	Alpaca, sheep and llama are the primary herd animals, since all can utilize the shorter pasture at higher elevations. Cattle are more restricted to lower areas. Oxen are rarely used for plowing. Pigs and chickens are usually not kept by rural families who migrate seasonally.
Alpaca	High	5000	
Sheep	High	5000	
Cattle	Low	4500	
Pigs	Low	4500	
Guinea pigs	Mod.	5000	
Chickens	Low	4500	

^aReproduced with permission of the Institute of Ecology from Baker and Little (1976:389).



Figure 21. Most varieties of quinoa (center) and cañihua (right) are unaffected by a heavy snowfall. A field of barley growing on the lower slope in the background was flattened by the snow and most of the crop was lost. Cultivation on valley floors is limited to areas below 4000 m by the increased frequency and intensity of frosts which occur above this altitude.

microzones. Dulce potatoes and quinoa are concentrated at lower elevations; amarga potatoes and cañihua allow the extension of cultivation 200 m higher. Within each microzone a number of varieties of each cultigen are planted, each having slightly different growing patterns, resistances, and qualities as food.

A number of factors other than altitude limit the arability of land in the district. These restrictions include soil conditions, slope, exposure, water availability, drainage, and incidence and intensity of local frosts (Figures 22-26). For example, the dry, steep slopes adjoining much of the lower valley are not extensively used for cultivation. Western exposure is considered preferable to eastern exposure since rapid thermal change caused by the intense morning sunlight on frost-covered crops can result in considerable damage. Without irrigation, soil moisture in much of the lower valley floor is inadequate for crops. Furthermore, frosts on the valley floor are more frequent than on the adjacent lower slopes. Areas best suited for agriculture are then the lower, less abrupt slopes which are well-watered and have a western exposure. Surveys in the district have estimated that less than 2% of the total land area is suitable for agriculture (Schaedel, 1959). This value does not reflect actual land under cultivation since a large portion must be left in fallow (from 2 to 12 years following 2 years of use). Finally, as a consequence of climatic instability, production from land under cultivation varies considerably from place to place, and year to year. Frosts in December can kill the new sprouts; hail directly preceding the quinoa and cañihua harvest may dislodge the ripe grain; insect attacks can result in extensive damage; too much rain can lead to rot and crop loss. In view of the limited arable land in Nuñoa and its productive inconsistency in a given area, it is expected that alternative subsistence patterns would be necessary to support the Nuñoa population. The natural flora does not appear to contribute significantly in this regard. It is therefore necessary to look beyond this trophic level to the natural and domestic consumers.

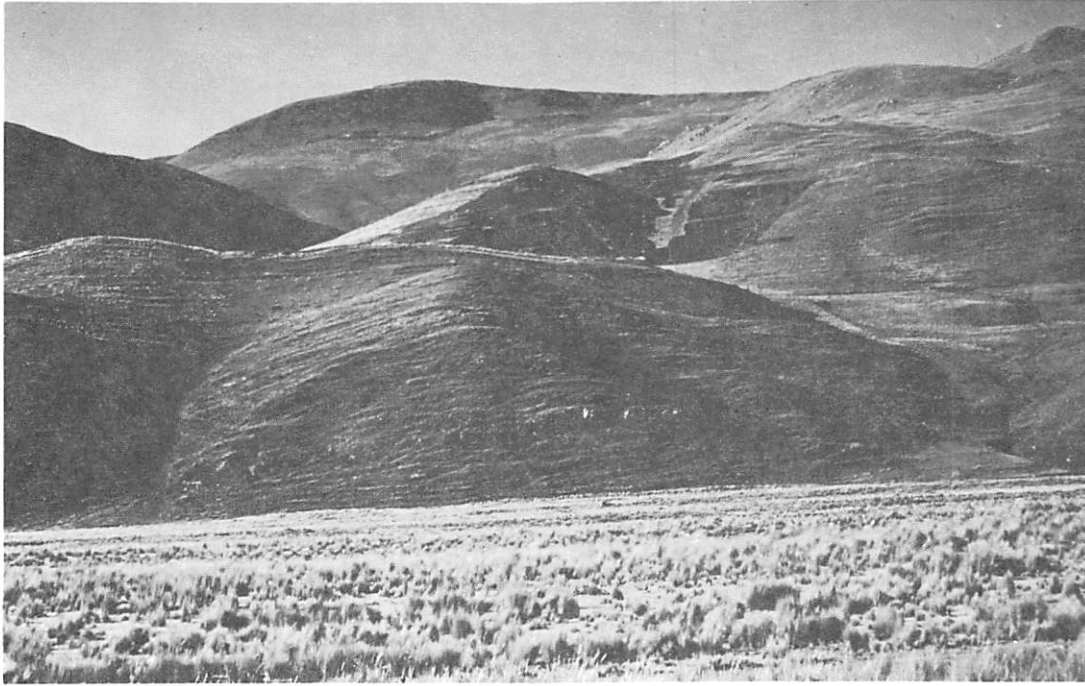


Figure 22. Most cultivation takes place on lower hillsides because they are less prone to frost. Here, recently prepared fields lie above an area once used for agriculture but now heavily eroded. A number of environmental conditions on the altiplano combine with crop production requirements to limit the amount of arable land.



Figure 23. Considerable human effort is required to prepare potato fields. In the year following the potato crop, this field will be planted with Andean cereals (see Figure 21) and then left fallow for several years.



Figure 24. Animal dung is used both as fuel and as fertilizer. It is collected in corrals, transported on llamas to the freshly prepared potato fields, and applied directly to the soil before planting. Dung is not applied prior to the planting of the Andean cereals.

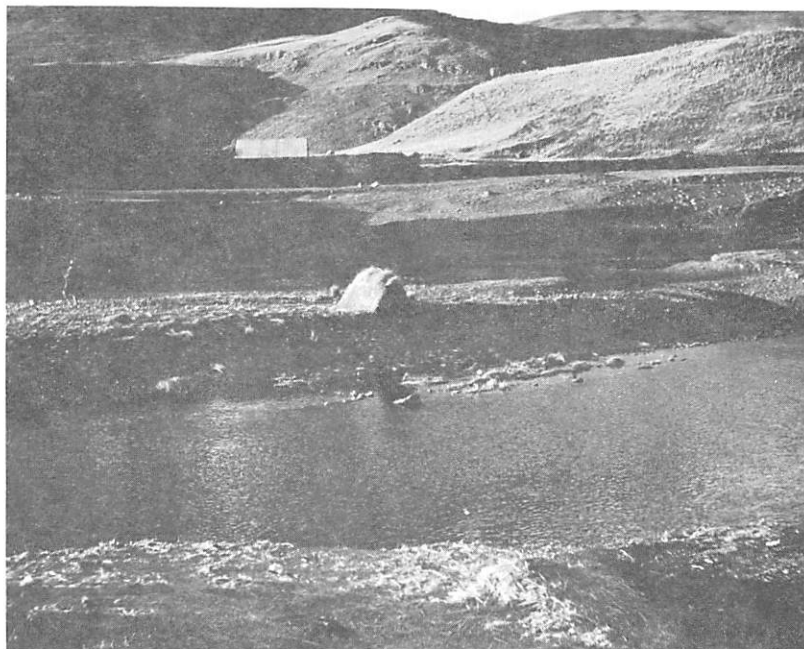


Figure 25. The hardy amarga potato is submerged beneath mats of straw and rock in the river in order to leach out its bitter taste. This process takes several weeks during which a guardian lives in the small shelter to prevent thievery.



Figure 26. During the dry season, the low relative humidity and high insolation of daytime, and the freezing temperatures of nighttime provide the conditions for potatoes to be dehydrated. Potatoes processed this way are light and compact, and can be stored for long periods. Water is squeezed from the potatoes by walking on them several times a day.

Domestic Animals

There have been few attempts to introduce domestic fowl or small mammals into the rural areas. Exceptions have been the dog, occasionally the cat, and the guinea pig. All three may be viewed as playing a symbiotic role with the human group to which they are attached. The dog protects crops and animals against thievery and assists in herding. The role of the cat, if any, is to reduce rodent populations and thus protect the stored food. The guinea pig is used as a ceremonial food source and a food reserve. All three domesticates are fed on scraps (i.e., potato peels and bones, and in the case of dogs, human excrement) and thus do not directly compete for human food resources.

Major alterations of natural animal populations in the district have resulted from placing domestic herbivores into habitats formerly occupied by the vicuña, guanaco, and deer. Replacement herbivores are the alpaca, llama, sheep, cow, and horse. The llama and alpaca probably replaced the wild camelids over much of central highland Peru with their domestication in the period between 2500 and 1750 B.C., while the cow, horse, and especially the sheep, occupied the range and displaced significant numbers of wild and domesticated camelids following the Spanish invasion (Pires-Ferreira et al., 1976).

As in the case for cultigens, importance of these domesticates is in part indicated by their distribution. Alpaca and llama herds, although found throughout the district, are largest at higher elevations. The major concentration of sheep lies in an intermediate altitude zone, and cattle usually occupy the lower valley floors. This distribution appears to be related to differences in grazing patterns as well as to tolerance of climatic stress. Cattle, for example, have difficulty grazing effectively on the short grasses at higher altitude. The lower fertility of cattle and the low viability of their young in the upper altitudes of the district is a reason frequently given for their absence in these higher sectors. Horses are neither numerous nor do they appear in herds. Families in the more remote areas generally have several to fulfill transportation needs. The horse is considered essential in this respect, which may

account for its distribution irrespective of altitude. Because it is not a food source, as are the other domesticates, its fitness at a given altitude is of less consequence.

Given the limited capacity to alter the biotic environment for agriculture, the people of Nuñoa rely on pastoralism as an alternative subsistence pattern. The advantages of domesticated herbivores in the high puna stem principally from their efficient utilization of the environment, and from the fact that they consume plants which have no utility to the human population. Unlike cultigens which are dependent upon conditions in a restricted area, herbivores can utilize pasture sources throughout the district. They are less influenced by local climatic disturbances and therefore constitute a more reliable food source. Thus, although a moderate drought may destroy a large portion of crops, it is likely that the domestic herbivores would survive by relying upon mobility and their greater endogenous food reserves.

Land and pasture quality appear as important limitors to herd size. Animal to land ratios within Nuñoa vary from 0.5 to 3.5 sheep equivalents per hectare; a sheep equivalent being the amount of land necessary to support a 40-kg sheep per year (see Figure 17). Pasture in the higher, well-watered areas of Nuñoa is generally considered as good grazing for camelids. These areas have a high composition of succulent herbs, especially important for alpaca (Figures 27 and 28). A major limiting factor of herd size and pastoralism as a subsistence pattern appears to be the availability of green pasture throughout the dry season (Koford, 1957). Herds converge on well-watered areas during this period and must be supported there for a minimum of three months. A more detailed description of pastoralism, as well as other subsistence practices in the Nuñoa area, are provided by Thomas (1973).

In general, the physical and biotic environment of Nuñoa and the common characteristics and constraints of this ecosystem conform closely to those discussed for the wet puna--an environment with a variety of microclimates which vary both in time and space. For the human population that depends upon the immediate ecosystem for its support, adaptive strategies reflect the environment's complexity. The population

functions ecologically as an important primary, and dominant secondary consumer, gaining access to material and energy flows primarily through locally derived cultigens and domestic animals (Figure 29). These plant and animal species have been modified and regulated by human groups for centuries in an attempt to adjust them to diverse environmental conditions, as well as human constraints. As a result, a variety of cultivars are utilized which compliment one another in tolerance, requirements, scheduling, and production. A similar complementary pattern exists between cultigens and domestic animals. Cultivation in Nuñoa results in intensive utilization of small, dispersed areas up to 4450 m. Pastoralism, on the other hand, can be carried out throughout the ecosystem, up to the frost desert.

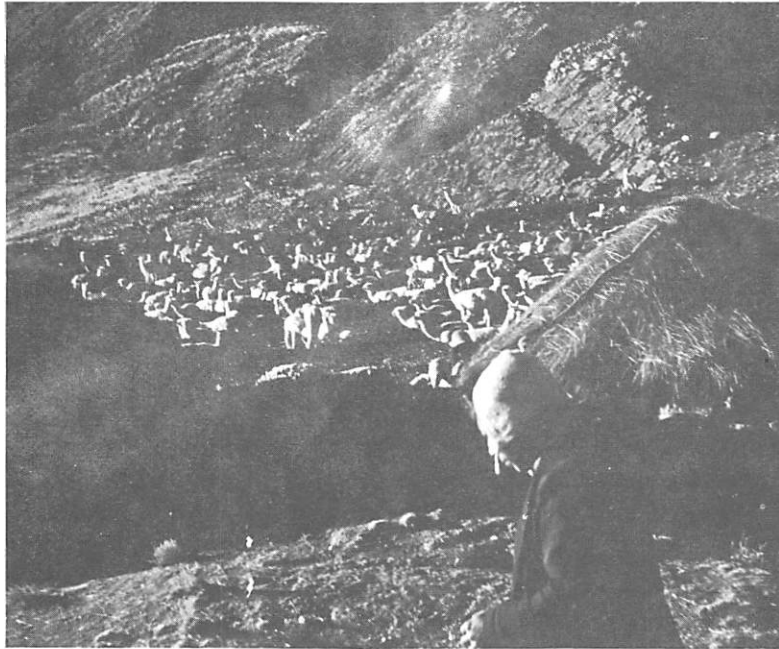


Figure 27. This residence with an adjoining corral is typical of rural families who live in a dispersed settlement pattern. Each residence generally has separate structures for sleeping, cooking and eating, and for storage. Herds graze throughout the day and are returned to corrals at night. The dung they leave in the corral represents a concentration of nutrients and organic matter which is used for fertilizer or fuel.



Figure 28. The availability of green pasture through the dry season appears to be an important factor influencing herd size. As shown here, access to well-watered valley floors is important for herding during this season. The dark area on the lower slopes (right) is dung in the corrals of the residence shown in Figure 27.

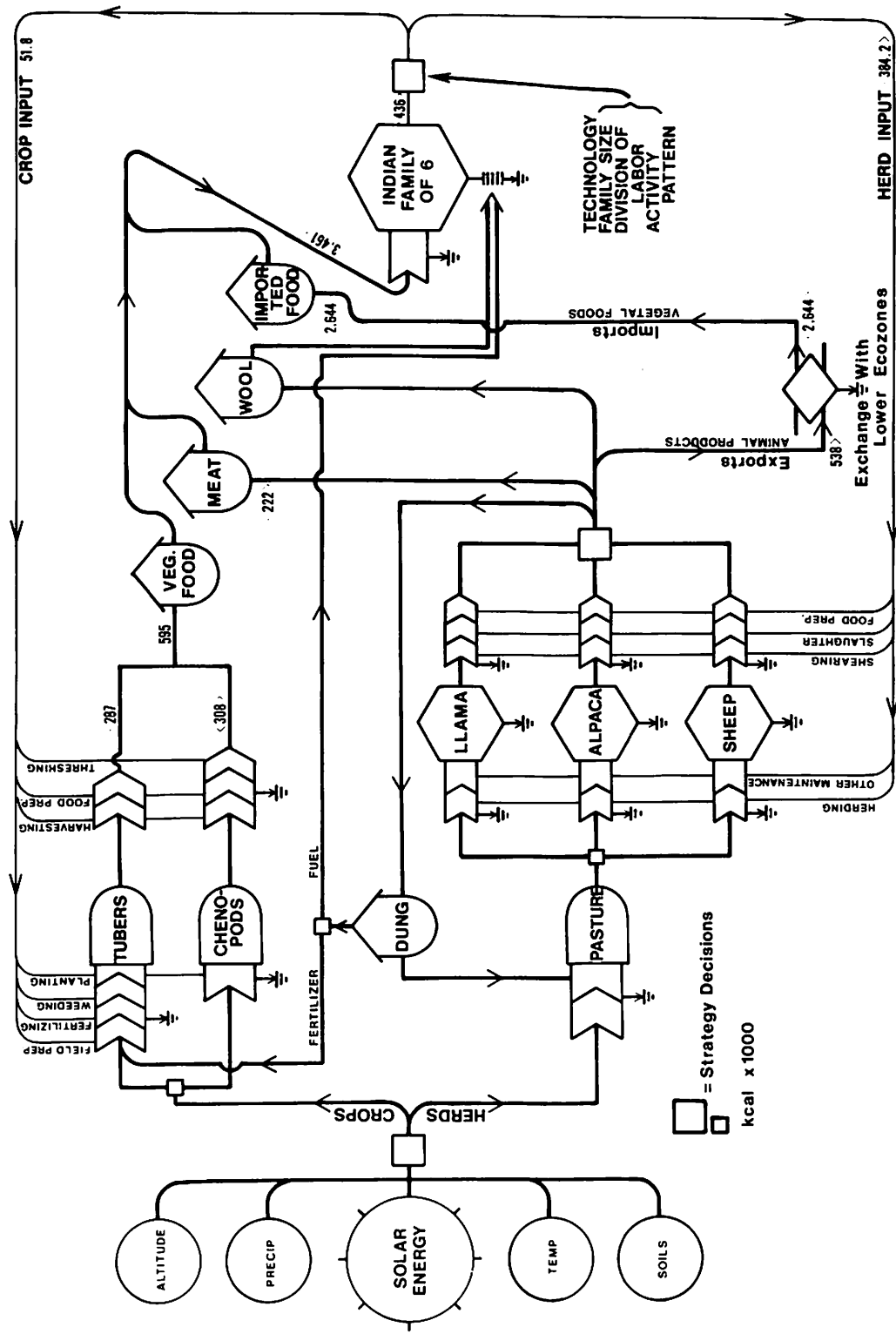


Figure 29. Simplified energy flow diagram of Nuñoa rural population. (Reproduced with permission of W. C. Brown, Dubuque, Iowa, from Thomas, 1973.)

HUMAN MODIFICATION OF THE ENVIRONMENT

A complex and interdependent mix of resources is used by the Nunoa human group. We view reliance on these resources as an adjustment to a patchy and variable environment entailing substantial modification by humans of the biotic community. Modification, in turn, is a continuous process requiring biobehavioral adjustments on the part of humans. The subsistence system appears to be effective in reducing environmental perturbations and in increasing human access to material and energy flows of the biotic community.

Environmental Degradation

Human modification of the altiplano environment, the duration of human habitation, and the size and economic organization of the pre-Conquest human populations in the southern Peruvian highlands underlie the importance of considering the human role in shaping contemporary biota. Specific research on the effects of humans on the highland ecosystem is, however, limited and unsystematic. ONERN/CORPUNO Vol. I (1965) reports that deforestation, degradation of pastures, and soil erosion are widespread in southern Peru. Crawford et al. (1970; quoting Ellenberg, 1958) attribute a depression of altiplano treeline from a natural climax at 4600 m to the current and "artificially low" 4000 m to biotic causes, specifically overgrazing. Citing human influences mediated through the effects of fire and overgrazing, Ellenberg (1964) states, "...most of the montane steppes of the Andes may be considered as semi-natural communities...Steppes and semideserts arose where the climate would permit a much more luxuriant natural vegetation." Because the vast puna grasslands were common at the time of Conquest, deforestation must have occurred much earlier. It is likely that the cutting of trees for construction and fuel contributed to the disappearance of highland forests (Budowski, 1968). Heizer (1955, referencing Wickes and Lowdermilk, 1938) suggests that one function of terracing was to check slope erosion following

the removal of ancient forests. In recent times, shrubs and other woody vegetation have been removed from large, eroded areas to provide fuel for population centers and railroads (Cabrera, 1968). In addition, Dourojeanni (1972) has noted with concern the continued cutting of what were once vast stands of queñua (Polylepis sp.) and quisuar (Buddleja sp.) trees, as well as the endangered status of many alti-plano animals.

Browman (1974) indicates that overgrazing is a problem of great antiquity. Evidence of severe erosion, attributable in part to overgrazing, dates back 2000 years in the Jauja-Huancayo Basin (Browman, 1970). He also notes that insufficient pasture in the Lake Titicaca area was reported prior to and during the Inca occupation (referencing Diez de San Miguel, 1567). Koford (1957) and Mann (1968) mention that post-Conquest overgrazing by sheep may have led to soil erosion and invasion of weedy species. The present dominance by coarse and unpalatable bunch grasses might in part result from heavy utilization by sheep of more succulent plants (Koford, 1957).

While none of these reports is detailed, they do indicate the kinds of major alterations of altiplano biota and soils which would have multiple ramifications throughout this ecosystem (Sternberg, 1968). As Billings (1973) has stated, although some alpine vegetations recover from severe disturbance, the majority do not. Environmental fragility has become a frequently used term referring to the relative ease with which ecosystems can be disrupted and irreversibly degraded. It seems paradoxical that high-mountain biota, which emphasizes a high degree of resilience should fall into this category. However, two factors support the application of the term to human-occupied tropical high-mountain areas.

First, a disproportionate number of highland plants are low and compact with extensive root systems that impede soil erosion. This becomes especially significant when such plant communities are located on slopes, since actions such as deforestation, burning, overgrazing, trampling of plant cover by hooved animals, cultivation, and road construction can destroy portions of this vegetative layer and drastically increase the downslope flow of soil and substrate material.

Once this has occurred to a sufficient degree, the vegetation, soil, and water quality of the upland and receiving areas become affected, and environmental quality can become degraded for long periods of time over extensive regions. Secondly, the extent to which fragility and downslope flow become environmental problems depends upon the manner and intensity with which humans use the land. The decimation of a substantial portion of the Andean human population during the first century of colonial control caused direct population pressure on highland resources to decline dramatically. This problem, however, is beginning to reappear as the population of Peru is currently surpassing that estimated for pre-Conquest periods. Since the turn of the century the human population has increased almost fourfold to 15 million inhabitants in 1975 (Eckholm, 1975). Shortening of the fallow period, cultivation of steeper slopes (Watters, 1971) and overgrazing in highland areas suggest that deterioration of the environment will become an ever-increasing problem in the future. Environmental problems like these reduce environmental productivity and the human capacity to use highland resources, and must therefore be considered in any study of human adaptation.

Human Adaptation

The purpose of this monograph has been to review the physical and biotic environment of southern highland Peru so that human adaptive responses can be studied and analyzed in a more precise manner. Only when environmental conditions are described in detail within a general conceptual framework is it possible to identify appropriate, adaptive responses. The ability to identify these with some confidence seems critical if we are to anticipate the increasing--and often deleterious--effects of change on highland human and environmental systems.

Environmental problems influencing all highland organisms have been described. It is possible, however, to be more specific about these problems when humans alone are considered. While human subsistence patterns on the altiplano vary considerably from area to area, we have focused on peasant groups reliant upon agro-pastoral

activities in the wet puna. Nuñoa serves as an example of this prevalent pattern of human-environment interaction. From this case it is possible to identify general environmental conditions which affect not only the humans residing in the Nuñoa ecosystem, but potentially other highland peasant groups as well:

- I. Environmental heterogeneity in time, space and pattern.
- II. Unpredictable occurrence of environmental problems and opportunities.
- III. Limited ability to channel food energy into the human group.
- IV. Environmental fragility.
- V. Downslope flow of materials.

These factors, combined with the aforementioned stressors affecting all highland organisms, constitute the range of environmental conditions influencing humans, their cultigens, and domestic animals. These conditions are the factors that peasant groups must either adjust to, modify, or find some way of avoiding.

While environmental problems and the harshness of the highlands are frequently emphasized in the literature, these conditions also provide environmental opportunities. With the exception of respiratory disorders, infectious disease is less common among highland than lowland populations (Buck et al., 1967; Way, 1976). Likewise there is a clear reduction in the incidence of parasitic infections such as malaria, schistosomiasis, and ascariasis (Clegg et al., 1970). Environmental heterogeneity suggests that a wide array of resources are available for human consumption. Cold nighttime temperatures permit the dehydration and storage of foods that would spoil at lower altitudes; high evaporation rates produce salt deposits in shallow highland lakes which are of value to humans and herds alike. Exposure of a varied substrate facilitates the location and mining of minerals. Finally, downslope flows can become important in channeling and concentrating the movement of resources. Fertile soils build up on some valley floors, and power generated by a descending water supply can be diverted to irrigate both pastures and croplands, as well as to

produce electricity. It is the ability of highland groups to create opportunities out of what are seemingly environmental problems which so typifies their adaptive responses. However, to do so requires a detailed understanding of the environment's complexity, unpredictability, limitations, and fragility.

The apparent adaptive success of human groups on the altiplano is suggested by their long-term presence, population size, and by the series of pre-Conquest civilizations which flourished in this region (Baker, 1969), as well as by the persistence of patterns of environmental modification along altitudinal gradients (Murra, 1968, 1972; Brush, 1976). This success is largely explained by the wide range of adaptive responses humans employ to buffer environmental stressors, or modify the biotic environment. Humans, in contrast to other animals, place high emphasis on behavioral (cultural and social) strategies involving technology, and on both intra- and inter-group cooperation. These strategies, in combination with physiological and morphological adjustments, decrease environmental perturbation and increase the quantity and variety of resources available.

Resources emphasized on the altiplano are those capable of adjusting to and producing well in a variety of microzones. They are generally amenable to storage, transport, and exchange with products of other regions. When possible, a multiple resource base consisting of items having different environmental tolerances and recovery rates is used. These often have nonconflicting schedules, and are spacially accessible to localized groups. Production techniques generally call for a dispersion of resources in time and space in order to avoid a simultaneous loss. This requires high mobility on the part of the productive unit, and dispersion of settlement pattern. Finally, exchange between productive units of the same group serves to buffer the effects of localized resource loss and provides access to labor for tasks which the unit could not perform alone. Exchange between groups residing in different zones has the same function in addition to providing essential resources not produced on the altiplano.

Consequences of Change

Although it is not the purpose of this monograph to review biological and behavioral strategies employed by peasant groups on the altiplano, these responses guide human utilization and modification of the region. It can be hypothesized that the general human adaptive responses reflect a high degree of resilience or flexibility in the same manner that other organisms emphasize this identical adaptive quality (Thomas, 1978). Human biological responses would be expected to have considerable phenotypic plasticity; evidence for this is reviewed by Mazess (1975), Baker and Little (1976), and Frisancho (1975). Recent summaries of literature on behavioral and socio-cultural adaptive responses may be found in Alberti and Mayer, 1974; Browman, 1974; Brush, 1976; Flores Ochoa, 1977; Mitchell, 1976; Murra, 1975; Thomas, 1978; and Webster, 1973.

In view of the rapid and pervasive changes, both planned and unplanned, which will affect the highlands in the next few decades, it would be useful to anticipate their consequences on the human and environmental systems. Unfortunately, with so little known about (1) the complex highland environmental conditions, (2) the biocultural responses which have allowed humans to adjust to these conditions, and (3) the scale and rate with which deterioration is taking place, it is difficult to presently assess the consequences of change. This suggests that a thorough collection of data concerning structure, function, and process in mountain human/environmental systems is critical. Although undesirable in the long-term, programs will be pushed ahead based on information presently available, because solutions must be sought urgently. If this is to be the case, it is therefore appropriate and necessary to establish a more systematic conceptual framework which could utilize existing knowledge in order to provide a basis for anticipating some of the more common and disruptive consequences of change (Thomas, 1978). Such a framework would identify and provide adaptive generalizations about critical, interacting variables in highland/environmental systems. It would focus on the human subsystem and those environmental conditions that bear directly upon its adaptiveness or well-being. This is not to say

that a knowledge of ecological structure, function and process is unimportant. Instead, it acknowledges that human populations and their interactions with the environment are of principal concern. Given the environmental complexity of highland regions, and the time and effort it would take to gather basic ecological data, it seems more prudent to focus upon humans, their resources, and the environmental factors that directly impinge on their ability to produce these resources.

Considerable attention has been given in the literature to what humans are doing wrong in their physical and biotic environment. In present circumstances, an opposite research approach is probably more realistic and more likely to be productive. This is based on the assumption that human populations having long-term exposure to a region are aware of environmental problems and opportunities and have made adjustments to them. This, of course, is not to say that everything they do is adaptive, or that recent changes in environmental conditions have not altered the effectiveness of some responses. Despite change, however, it is assumed that a great deal of their responses remain appropriate. Thus, an attempt should be made to identify what humans do right in adjusting to the conditions of mountainous regions, and how certain changes are capable of disrupting these adaptive responses.

This approach appears warranted in view of our rather limited predictive abilities in anticipating the systemic consequences of many planned change programs. Until these predictive abilities substantially improve, it may be appropriate to take a cautious perspective, outlining critical variables in the human/environment system that must be maintained if the system as we understand it is to persist. Reviewing environmental conditions which influence human responses is but the first step.

REFERENCES CITED

- Alberti, G. and E. Mayer. 1974. Reciprocidad e Intercambio en los Andes Peruanos. Instituto de Estudios Peruanos. Lima.
- Altland, P. D. and B. Highman. 1971. Effects of polycythemia and altitude hypoxia on rat heart and exercise tolerance. *Amer. J. Physiol.* 221:338-393.
- Baker, P. T. 1969. Human adaptation to high altitude. *Science* 163: 1149-1156.
- _____, G. Escobar, G. DeJong, C. J. Hoff, R. B. Mazess, J. M. Hanna, M. A. Little, and E. Picon-Reategui. 1968. High altitude adaptation in a Peruvian community. *Occasional Papers in Anthropology* No. 1. Pennsylvania State Univ., University Park, PA.
- _____, and M. A. Little. 1976. *Man in the Andes: a multidisciplinary study of high-altitude Quechua.* Dowden, Hutchinson and Ross, Inc., Stroudsburg, PA.
- Beals, E. 1969. Vegetational change along altitudinal gradients. *Science* 165:981-985.
- Beek, K. J. and D. L. Bramao. 1968. Nature and geography of South American soils. *In* E. J. Fittkau *et al.* (eds.), *Biogeography and ecology in South America.* Dr. D. W. Junk, Publishers, The Hague. pp.82-112.
- Bennett, W. C. and J. B. Bird. 1960. *Andean culture history.* Natural History Press, Garden City, New York.
- Billings, W. D. 1973. Arctic and alpine vegetations: similarities, differences, and susceptibility to disturbance. *Bio.Science* 23:697-704.
- Browman, D. L. 1970. *Early Peruvian peasants: the culture history of a central highlands valley.* Unpublished Ph.D. dissertation. Harvard Univ., Cambridge, Mass.
- _____, 1974. Pastoral nomadism in the Andes. *Current Anthropol.* 15:188-196.
- Brush, S. B. 1976. Man's use of an Andean ecosystem. *Hum. Ecol.* 4:147-166.
- Buck, A. A., T. T. Sasaki, R. I. Anderson, J. C. Hitchcock, and G. R. Leigh. 1967. Comprehensive epidemiological studies of four contrasting Peruvian villages. Geographic Epidemiology Unit. Johns Hopkins Univ., Baltimore, MD.
- Budowski, G. 1968. La influencia humana en la vegetación natural de montañas tropicales Americanas. *In* C. Troll (ed.), *Geo-ecology of the mountainous regions of the tropical Americas.* Ferd. Dümmlers Verlag, Bonn. pp. 157-162.
- Bullard, R. W. 1972. Vertebrates at altitudes. *In* M. K. Yousef, S. M. Horvath and R. W. Bullard (eds.), *Physiological adaptations: desert and mountain.* Academic Press, New York. pp. 209-225.

- Cabrera, A. L. 1968. Ecologia vegetal de la puna. In C. Troll (ed.), Geo-ecology of the mountainous regions of the tropical Americas. Ferd. Dümmlers Verlag, Bonn. pp. 91-116.
- Cardenas, M. 1969. Manual de plantas economicas de Bolivia. Impr. Icthus. Cochabamba, Bolivia.
- Chioldi, H. 1970-71. Comparative study of the blood gas transport in high altitude and sea level camelidae and goats. *Respir. Physiol.* 11:84-93.
- Clegg, E. J., G. A. Harrison and P. T. Baker. 1970. The impact of high altitude on human populations. *Hum. Biol.* 42:486-518.
- Consolazio, C. F., R. E. Johnson and L. J. Pecora. 1963. Physiological measurements of metabolic functions in man. McGraw Hill, Inc., New York.
- Crawford, R. M. M., D. Wishart, and R. M. Campbell. 1970. A numerical analysis of high altitude scrub vegetation in relation to soil erosion in the eastern Cordillera of Peru. *J. Ecol.* 58(1):173-191.
- Crowe, P. R. 1971. Concepts in climatology. St. Martin's Press, New York.
- Cruz-Coke, R., A. P. Cristoffanini, M. Aspillaga, and F. Biancani. 1967. Evolutionary forces in human populations in an environmental gradient in Arica, Chile. *Hum. Biol.* 38:421-438.
- Darden, T. R. 1972. Respiratory adaptations of a fossorial mammal, the pocket gopher (Thomomys bottae). *J. Comp. Physiol.* 78:121-137.
- Darlington, P. J., Jr. 1965. The biogeography of the southern end of the world. Harvard Univ. Press, Cambridge.
- Daubenmire, R. F. 1947. Plants and environment: a textbook of plant autecology. John Wiley & Sons, New York.
- Deustua, J. L. 1972. Organizacion de una hacienda ganadera en Puno. Ministerio de Agricultura, Informe No. 28. Peru.
- Diez de San Miguel, G. 1567 (1964). Visita hecha a la provincia de Chucuito por Garci Diez de San Miguel en el ano 1567. Documentos Regionales para la Ethnohistoria Andina 1. Casa de la Cultura del Peru, Lima.
- Dourojeanni, M. 1972. Flora y fauna del Peru: importancia de su conservacion. El Serrano 272. Lima, Peru.
- Eaton, J. W., T. D. Skelton, and E. Berger. 1974. Survival at extreme altitude: protective effect of increased hemoglobin-oxygen affinity. *Science* 183:743-744.

- Eckholm, E. P. 1975. The deterioration of mountain environments. *Science* 189:764-770.
- Eidt, R. C. 1968. The climatology of South America. In E. J. Fittkau et al. (eds.), *Biogeography and ecology in South America*. Dr. D. W. Junk, Publishers, The Hague. pp. 54-81.
- Ellenberg, H. 1958. Wald oder steppe? Die naturliche Pflanzendecke der Anden Perus: I and II. Umschau.
- _____, 1964. Proceedings and Papers of the IUCN 9th Technical Meeting (Nairobi, September 1963). IUCN Publications, New Series 4(II):172-177.
- Fittkau, E. J. 1968. The fauna of South America. In E. J. Fittkau et al. (eds.), *Biogeography and ecology in South America*. Dr. D. W. Junk, Publishers, The Hague. pp. 624-658.
- Flores Ochoa, J. A. 1977. Pastores de Puna. Uywamichiq Punarunakuna. Instituto de Estudios Peruanos. Lima, Peru.
- Folk, G. E. 1974. Textbook of environmental physiology (2nd ed.) Lea and Febiger, Philadelphia.
- Frisancho, A. R. 1975. Functional adaptation to high altitude hypoxia. *Science* 187:313-319.
- Garbell, M. A. 1947. Tropical and equatorial meteorology. Pitman, New York.
- Grahn, D., and J. Kratchman. 1963. Variation in neonatal death rate and birth weight in the United States and possible relations to environmental radiation, geology and altitude. *Amer. J. Hum. Genet.* 15(4): 329-352.
- Hall, F. J., D. B. Dill and E. S. Guzman. 1936. Comparative physiology in high altitudes. *J. Cell. Comp. Physiol.* 8:301-313.
- Heizer, R. F. 1955. Primitive man as an ecological factor. Kroeber Anthropological Society Papers:13.
- Hodge, W. H. 1946. Cushion plants of the Peruvian puna. *J. N.Y. Bot. Garden* 47(558):133-141.
- Holdridge, L. R. 1957. Life zone ecology. Tropical Science Center, San Jose, Costa Rica.
- Hultquist, B. 1956. Studies on naturally occurring ionizing radiation. *Kungl-Svenska Vetenskapsakademiens Handlinger*, Vol. 6.
- James, D. E. 1973. The evolution of the Andes. *Sci. Amer.* 229(2):60-67.
- Jenks, W. F. 1956. Peru. In W. F. Jenks (ed.), *Handbook of South American geology* (Geological Society of America. Memoir 65). Waverly Press, Baltimore, MD. pp. 215-247.

- Johnson, A. M. 1976. The climate of Peru, Bolivia and Ecuador. In W. Schwerdtfeger (ed.), World survey of climatology, Volume 12: climates of Central and South America. Elsevier Scientific Publishing Co., Amsterdam. pp. 147-188.
- Koford, C. 1957. The vicuña and the puna. *Ecol. Monogr.* 27(2):153-219.
- Larsen, R. M. 1973. The thermal micro-environment of a highland Quechua population: biocultural adjustment to cold. M. A. thesis. Univ. of Wisconsin, Madison.
- Lettau, H. 1976. Dynamic and energetic factors which cause and limit aridity along South America's Pacific coast. In W. Schwerdtfeger (ed.), World survey of climatology, Volume 12: climates of Central and South America. Elsevier Scientific Publishing Co., Amsterdam. pp. 188-192.
- Leith, H. 1973. Primary production: terrestrial ecosystems. *Hum. Ecol.* 1(4):303-332.
- Little, M. A. 1968. Racial and developmental factors in foot cooling: Quechua Indians and U.S. whites. In High altitude adaptation in a Peruvian community. Occasional Papers in Anthropology, No. 1. Pennsylvania State Univ., University Park, PA. pp. 327-537.
- Mann, G. 1968. Ökosysteme Sudamerikas. In E. J. Fittkau et al. (eds.), Biogeography and ecology in South America. Dr. D. W. Junk, Publishers, The Hague. pp. 171-229.
- Mazess, R. B. 1975. Human adaptation to high altitude. In A. Damon (ed.), Physiological anthropology. Oxford, New York. pp. 167-209.
- Mitchell, W. P. 1976. Irrigation and community in the central Peruvian highlands. *Amer. Anthropol.* 78:25-44.
- Morrison, P. R. 1962. Temperature regulation in animals native to tropical and high altitude environments. In J. P. Hannon and E. Viereck (eds.), Comparative physiology of temperature regulation. Proc. 2nd Symp. Arctic Biol. Med. Arctic Aeromedical Laboratory, Fort Wainwright, Alaska. pp. 381-413.
- _____, 1964. Wild animals at high altitudes. *Symp. Zool. Soc. London*, 13:49-55.
- _____, K. Kerst, C. Reynafarje and J. Ramos. 1963a. Hematocrit and hemoglobin levels in some Peruvian rodents from high and low altitude. *Int. J. Biometeorol.* 7:51-58.
- _____, K. Kerst and M. Rosenmann. 1963b. Hematocrit and hemoglobin levels in some Chilean rodents from high and low altitude. *Int. J. Biometeorol.* 7:45-50.

- Murra, J. V. 1965. Herds and herders in the Inca state. In A. Leeds and A. P. Vayda (eds.), Man, culture and animals. AAAS. Washington, D.C. pp. 185-216.
- _____, 1968. An Aymara kingdom in 1567. Ethnohistory 15:115-151.
- _____, 1972. El "control vertical" de un maximo de pisos ecologicos en la economia de las sociedades andinas. In Inigo Ortiz de Zuniga, Vista de la Provincia de Leon de Huanuco (1562), Vol. 2. Univ. Hermilio Valdizan, Huanuco. pp. 429-476.
- _____, 1975. Formaciones economicas y politicas del mundo Andino. Instituto de Estudios Peruanos. Lima, Peru.
- Olrog, C. C. 1968. Birds of South America. In E. J. Fittkau et al. (eds.), Biogeography and ecology in South America. Dr. D. W. Junk, Publishers, The Hague. pp. 849-878.
- ONERN/CORPUNO. 1965. Programa de inventariy evaluacion de los recursos naturales del Departamento de Puno, Sector de Prioridad I, 6 vols. Lima, Peru.
- Papadakis, J. 1969. Soils of the world. American Elsevier, New York.
- Pearson, O. P. 1951. Mammals in the highlands of southern Peru. Bull. Comp. Zool. 106(3).
- _____, 1959. Biology of the subterranean rodents ctenomys in Peru. Memorias del Museo de Historia Natural "Javier Prado," No. 9, Univ. Nacional Mayor de San Marcos, Lima, Peru.
- _____, and C. P. Ralph. 1978. The diversity and abundance of vertebrates along an altitudinal gradient in Peru. Memorias del Museo de Historia Natural "Javier Prado," No. 18, Univ. Nacional Mayor de San Marcos, Lima, Peru.
- Pires-Ferreira, J. Wheeler, E. Pires-Ferreira, and P. Kaulicke. 1976. Pre-ceramic animal utilization in the central Peruvian Andes. Science 194:483-490.
- Prohaska, F. 1970. Distinctive bioclimatic parameters of the subtropical-tropical Andes. Int. J. Biometeorol. 14(1):1-12.
- Putzer, H. 1968. Überblick über die geologische Entwicklung Sudamerikas. In E. J. Fittkau et al. (eds.), Biogeography and ecology in South America. Dr. D. W. Junk, Publishers, The Hague. pp. 1-24.
- Ruthsatz, B. 1974. Los arbustos de las estepas Andinas del Noroeste Argentino y su uso actual. Boletin de la Sociedad Argentina de Botanica XVI(1-2):27-45.
- Schaedel, R. P. 1959. Los recursos humanos del Departamento de Puno. Plan regional para el desarrollo del sur del Peru, Vol. 5. Lima, Peru.

- Schwabe, G. H. 1968. Towards an ecological characterization of the South American continent. In E. J. Fittkau et al. (eds.), Biogeography and ecology in South America. Dr. D. W. Junk, Publishers, The Hague. pp. 113-136.
- Schwerdtfeger, W. 1976a. High thunderstorm frequency over the subtropical Andes during the summer; cause and effects. In W. Schwerdtfeger (ed.), World survey of climatology, Volume 12: climates of Central and South America. Elsevier Scientific Publishing Co., Amsterdam. pp. 192-195.
- _____, 1976b. The water-budget of Lake Titicaca. In W. Schwerdtfeger (ed.), World survey of climatology, Volume 12: climates of Central and South America. Elsevier Scientific Publishing Co., Amsterdam. pp. 195-199.
- Shimwell, D. W. 1972. The description and classification of vegetation. Univ. of Washington Press, Seattle, Wash.
- Sick, W. D. 1968. Geographical substance. In E. J. Fittkau et al. (eds.), Biogeography and ecology in South America. Dr. D. W. Junk, Publishers, The Hague. pp. 449-474.
- Simmonds, N. W. 1965. The grain chenopods of the tropical American highlands. Econ. Bot. 19:223-235.
- Simpson, G. G. 1968. South American mammals. In E. J. Fittkau et al. (eds.), Biogeography and ecology in South America. Dr. D. W. Junk, Publishers, The Hague. pp. 879-909.
- Smith, E. E. and J. W. Crowell. 1963. Influence of hematocrit ratio on survival of unacclimatized dogs at simulated altitude. Amer. J. Physiol. 205:1172.
- Soil Survey Staff. 1975. Soil taxonomy: a basic system of soil classification for making and interpreting soil surveys. Soil Conserv. Serv., U.S. Dept. of Agric. Handbook. No. 436.
- Solon, L. R., W. M. Lowder, A. Shambon, and H. Blatz. 1960. Investigations of natural environmental radiation. Science 131:903-906.
- Sternberg, H. O'R. 1968. Man and environmental change in South America. In E. J. Fittkau et al. (eds.), Biogeography and ecology in South America. Dr. D. W. Junk, Publishers, The Hague. pp. 413-445.
- Thomas, R. B. 1973. Human adaptation to a high Andean energy flow system. Occasional Papers in Anthropology No. 7. Pennsylvania State Univ., University Park, PA.
- _____, 1978. Effects of change on high mountain human adaptive patterns. In P. J. Webber (ed.), High altitude geocology, Westview, Boulder, Colo. (In press.)
- Tosi, J. A. 1960. Zonas de vida natural en el Peru. Instituto Interamericano de Ciencias Agricolas de la OEA. Zona Andina Boletín Técnico No. 5, Lima, Peru.
- Tramer, E. J. 1969. Bird species diversity: components of Shannon's formula. Ecology 50:927-929.

- Troll, C. C. 1960. The relationship between the climates, ecology and plant geography of the southern cold temperate zone and of the tropical high mountains. Proc. Royal Soc. (London) Ser. B. 152:529-532.
- _____, 1968. The Cordilleras of the tropical Americas; aspects of climate, phytogeographical and agrarian ecology. In C. Troll (ed.), Geo-ecology of the mountainous regions of the tropical Americas. Ferd. Dümmlers Verlag, Bonn. pp. 15-56.
- Turek, Z., F. Kreuzer, and L. J. C. Hoofd. 1973. Advantage or disadvantage of a decrease of blood oxygen affinity for tissue oxygen supply at hypoxia: a theoretical study comparing man and rat. Pflugers Arch. 342:185-197.
- Ugent, D. 1970. The potato. Science 170:1161-1166.
- Vuilleumier, B. S. 1971. Pleistocene changes in the fauna and flora of South America. Science 173:771-780.
- Watters, R. F. 1971. Shifting cultivation in Latin America. FAO, Rome.
- Way, A. B. 1976. Morbidity and postneonatal mortality. In P. T. Baker and M. A. Little (eds.), Man in the Andes: a multidisciplinary study of high-altitude Quechua. Dowden, Hutchinson and Ross, Stroudsburg, PA. pp. 147-160.
- Weberbauer, A. 1936. Phytogeography of the Peruvian Andes. In J. F. MacBride, (ed.), Flora of Peru: Part I. Field Musium of Natural History, Botanical Series, Publication 351, Vol. 13. Chicago. pp. 13-80.
- _____, 1945. El mundo vegetal de los Andes Peruanos. Ministerio de Agricultura, Lima, Peru
- Webster, S. 1973. Native pastoralism in the south Andes. Ethnology 12:115-133.
- Wickes, D. R. and W. C. Lowdermilk. 1938. Soil conservation in ancient Peru. Soil Conserv. 4:91-94.
- Winterhalder, B., R. Larsen and R. B. Thomas. 1974. Dung as an essential resource in a highland Peruvian community. Hum. Ecol. 2:89-104.

**INSTITUTE OF ARCTIC AND ALPINE RESEARCH
OCCASIONAL PAPERS**

Numbers 1 through 5, and 11 and 12 are out of print. A second edition of Number 1 is available from the author. Numbers 2, 4, 5 and 11 are available from National Technical Information Service, U.S. Department of Commerce. For details, please write to INSTAAR.

6. *Guide to the Mosses of Colorado*. By W.A. Weber. 1973. 48 pp. Order from the author, University of Colorado Museum, Boulder, Colorado 80309. \$2.50.
7. *A Climatological Study of Strong Downslope Winds in the Boulder Area*. By W.A.R. Brinkmann. 1973. 228 pp. Order from the author, Institute for Environmental Studies, University of Wisconsin, 1225 West Dayton Street, Madison, Wisconsin 53706.
- †8. *Environmental Inventory and Land Use Recommendations for Boulder County, Colorado*. Edited by R.F. Madole. 1973. 228 pp. 7 plates. \$6.00.
- †9. *Studies of Climate and Ice Conditions in Eastern Baffin Island, 1971-73*. By J.D. Jacobs, R.G. Barry, R.S. Bradley, and R.L. Weaver. 1974. 77 pp. \$3.00.
- †10. *Simulation of the Atmospheric Circulation Using the NCAR Global Circulation Model With Present Day and Glacial Period Boundary Conditions*. By J.H. Williams. 1974. 328 pp. \$4.75.
11. *Solar and Atmospheric Radiation Data for Broughton Island, Eastern Baffin Island, Canada, 1971-73*. By J.D. Jacobs. 1974. 54 pp. (Out of print.) NTIS PB-248 955/7GA. Paper \$4.50. Microfiche \$2.55.
12. *Deglacial Chronology and Uplift History: Northeastern Sector, Laurentide Ice Sheet*. By A.S. Dyke. 1974. 113 pp. (Out of print.)
- †13. *Development of Methodology for Evaluation and Prediction of Avalanche Hazard in the San Juan Mountains of Southwestern Colorado*. By R.L. Armstrong, E.R. LaChapelle, M.J. Bovis, and J.D. Ives. 1975. 141 pp. \$4.75.
- †14. *Quality Skiing at Aspen, Colorado: A Study in Recreational Carrying Capacity*. By C. Crum London. 1975. 134 pp. 3 plates. \$5.50.
- †15. *Palynological and Paleoclimatic Study of the Late Quaternary Displacements of the Boreal Forest-Tundra Ecotone in Keewatin and Mackenzie, N.W.T., Canada*. By H. Nichols. 1975. 87 pp. \$4.00.
- †16. *Computer Techniques for the Presentation of Palynological and Paleoenvironmental Data*. By M. Nichols, M. Eccles, and H. Nichols. 1976 (in preparation).
- †17. *Avalanche Atlas: San Juan County, Colorado*. By L. Miller, B.R. Armstrong, and R.L. Armstrong. 1976. 260 pp. 60 plates. \$4.25.
- †18. *Century of Struggle Against Snow: A History of Avalanche Hazard in San Juan County, Colorado*. By B.R. Armstrong. 1976. 97 pp. 11 plates. \$4.50.
- †19. *Avalanche Release and Snow Characteristics, San Juan Mountains, Colorado*. Edited by R.L. Armstrong and J.D. Ives. 1976. 256 pp. 7 plates. \$7.50.
- †20. *Landslides Near Aspen, Colorado*. C.P. Harden. 1976. 61 pp. 5 plates. \$3.75.
- †21. *Radiocarbon Date List III. Baffin Island N.W.T., Canada*. By J.T. Andrews. 1976. 50 pp. \$2.50.
- †22. *Physical Mechanisms Responsible for the Major Synoptic Systems in the Eastern Canadian Arctic in the Winter and Summer of 1973*. By E.F. LeDrew. 1976. 205 pp. \$4.50.
- †23. *Procedures for the Study of Snow Avalanche Chronology Using Growth Layers of Woody Plants*. By C.J. Burrows and V.L. Burrows. 1976. 60 pp. \$4.00.
- †24. *Avalanche Hazard in Ouray County, Colorado, 1877-1976*. By B.R. Armstrong. 1977. 125 pp. 32 plates. \$4.50.
- †25. *Avalanche Atlas, Ouray County, Colorado*. By B.R. Armstrong and R.L. Armstrong. 1977. 132 pp. 34 plates. \$6.00.
- †26. *Energy Budget Studies in Relation to Fast-ice Breakup Processes in Davis Strait: Climatological Overview*. R.G. Barry and J.D. Jacobs with others. 1978. 284 pp. \$7.00.
- †27. *Geocology of Southern Highland Peru: a Human Adaptation Perspective*. By B. P. Winterhalder and R. Brooke Thomas. 1978. 91 pp. \$6.00.

†Order from INSTAAR, University of Colorado, Boulder, Colorado 80309. Orders by mail add 65 cents per title.

Occasional Papers are a miscellaneous collection of reports and papers on work performed by INSTAAR personnel and associates. Generally, these papers are too long for publication as journal articles, or they contain large amounts of supporting data that are normally difficult to publish in the standard literature.



A stylized "ankh," the ancient Egyptian sign for life, has been incorporated into the symbol of the Program on Man and the Biosphere (MAB).